

# OWNER'S MANUAL

CLASS A AND CLASS C MOTORHOMES



 **THOR**  
MOTOR COACH

Made to fit.



**⚠ WARNING**

Operating, servicing and maintaining a passenger vehicle or off-road vehicle can expose you to chemicals including engine exhaust, carbon monoxide, phthalates, and lead, which are known to the State of California to cause cancer and birth defects or other reproductive harm. To minimize exposure, avoid breathing exhaust, DO NOT idle the engine except as necessary, service your vehicle in a well-ventilated area and wear gloves or wash your hands frequently when servicing your vehicle.

For more information go to: [www.P65Warnings.ca.gov/passenger-vehicle](http://www.P65Warnings.ca.gov/passenger-vehicle)



*This Owner's Manual contains important safety, operational, and maintenance information. Please read this owner's manual carefully before operating this vehicle. Owner's Manual downloads are available at:*

<https://www.thormotorcoach.com/owners/owners-manuals>



# OWNER'S *MANUAL*

## CLASS A AND CLASS C MOTORHOMES

Congratulations with the ownership of your new motorhome and welcome to the wonderful world of RV'ing and to the Thor Motor Coach family of recreational vehicles.

We sincerely thank you for choosing the Thor Motor Coach brand. Our mission is to produce quality motorized recreational vehicles designed to provide you with carefree, comfortable travel and vacationing for now and for many years to come. We are confident that you will find your new motorhome is 'Made to fit' your recreational aspirations.

Your motorhome was built following the high standards set by Thor Motor Coach (TMC), the Recreational Vehicle Industry Association (RVIA), and (if applicable) the Canadian Standards Association (CSA) as well as complying with the requirements of all applicable state and federal agencies at the time of manufacture.

Our customers are extremely important to us, and we assure you that TMC will always strive to do everything possible to earn and retain your trust and goodwill.

Happy Travels!

THOR MOTOR COACH  
P. O. Box 1486  
Elkhart, Indiana 46515-1486

(Toll Free) 877.855.2867

[thormotorcoach.com](http://thormotorcoach.com)

DISCLAIMER: Thor Motor Coach (TMC) reserves the right to make changes in vehicles built and/or sold at any time without incurring any obligations to make the same or similar changes on vehicles previously built and/or sold by TMC. Information within this owner's manual is subject to change without notice and represents information relevant at the time this version was printed. Nothing in this owner's manual creates any warranty, either expressed or implied. The only warranties offered are those set forth in the Thor Motor Coach Limited Warranty and in the Thor Motor Coach Structural and Lamination Limited Warranty, as applicable to the motorhome.

TMC Part Number 0611687, Revision 260101

Copyright © 2026 Thor Motor Coach, Inc.

# Table of Contents

## Chapter 1: Introduction

About This Owner's Manual . . . . .	9
TMC Warranty Guide . . . . .	9
Chassis Manufacturer's Owner's Manual and Warranty . . . . .	9
TMC Owner's Packet . . . . .	9
Contact TMC Customer Care . . . . .	9
Online Customer Support . . . . .	10
TMC Owners Resource . . . . .	10
TMC Basic Operation Guides . . . . .	10
TMC System Guides . . . . .	11
TMC Instructional Videos . . . . .	11
Freightliner 24/7 Direct App . . . . .	11
Thor Diesel Club . . . . .	11
Important Disclaimers: . . . . .	11

## Chapter 2: Consumer Information

Dealer's Responsibilities . . . . .	13
Consumer's Responsibilities . . . . .	13
California Consumers Notice: . . . . .	14
Change of Address or Ownership . . . . .	14
Vehicle Identification Labels . . . . .	14
How to Obtain Assistance . . . . .	14
Suggestions for Obtaining Service . . . . .	15
Emergency, Weekend, or After Business Hours Assistance . . . . .	15
Service or Warranty Repair from Thor Motor Coach . . . . .	15
Warranty Service Availability Notice . . . . .	16
Replacement Parts . . . . .	16
Website Usage Disclaimers . . . . .	16
Thor Motor Coach® Recreational Vehicle Privacy Notice . . . . .	16
Chassis Information Notice . . . . .	17
Reporting Safety Defects . . . . .	17
In the United States . . . . .	17
In Canada . . . . .	17

## Chapter 3: Vehicle Safety

Safety Alerts . . . . .	19
Safety Labels . . . . .	19
Fire Safety . . . . .	19
Fire Extinguisher . . . . .	21
Smoke Alarm . . . . .	21
Carbon Monoxide (CO) . . . . .	22
Exhaust Fumes and Gases . . . . .	22

Propane Safety . . . . .	23
Combination Carbon Monoxide/Propane Alarm . . . . .	24
Fuel System Safety . . . . .	25
Location of Fuel Inlet . . . . .	26
Fuel Cap . . . . .	26
Freightliner Exhaust Emissions Systems . . . . .	26
Chemical Sensitivity . . . . .	27
Formaldehyde . . . . .	27
Smoking and Medical Advice . . . . .	27
Ventilation . . . . .	27
Emergency Egress Window . . . . .	28
Emergency Egress Procedure . . . . .	28
Swing Latch Operation: . . . . .	30
Lever Latch Operation . . . . .	30
Rear Cargo Door . . . . .	31
Front Airbags . . . . .	31
Seatbelts . . . . .	31
Child Safety Restraint System . . . . .	32
Transporting Pets . . . . .	33
Driver and Front Passenger Seats . . . . .	33
Mirrors and Vision Systems . . . . .	34
Mirrors . . . . .	34
Vision Systems . . . . .	35
Blind Spot Detection, Class A . . . . .	36
Blind Spot Detection, Class C . . . . .	40
Safely Driving the Motorhome . . . . .	42
Emergency Parking . . . . .	43
Laws of the Road . . . . .	43
Chassis Manufacturer's Vehicle Safety Features . . . . .	43

## Chapter 4: Tires and Wheels

Tire Safety . . . . .	45
Tire Inflation and Inspection . . . . .	45
Checking Tire Pressures . . . . .	45
Inspect the Condition of Your Tires . . . . .	46
Common Tire Wear Patterns . . . . .	46
Lug Nut Torque . . . . .	47
Wheel Alignment . . . . .	47
Changing a Damaged Tire . . . . .	47
Tire Identification Information . . . . .	48
Tire Replacement . . . . .	49
SmoothTech™ Suspension . . . . .	49

## Chapter 5: Weighing, Loading, and Towing

Introduction . . . . .	51
Important Weight Terminology . . . . .	51
Federal Weight Label (USA) . . . . .	52
Occupant and Cargo Carrying Capacity Weight Label (OCCC) . . . . .	53
Weight Capacity of Rear Garage Area . . . . .	53
Manufacturer Modified Label (USA) . . . . .	54
Manufacturer Modified Label (Canada) . . . . .	54
Canadian Recreational Vehicle Length Label . . . . .	54
Canadian Cargo Carrying Capacity Label . . . . .	55
Canadian Weight Label / Statement of Compliance . . . . .	55
Weighing Your Motorhome . . . . .	56
Weight Distribution . . . . .	57
Loading Your Motorhome . . . . .	57
Loading Motorhomes with Rear Cargo Door . . . . .	57
Towing With Your Motorhome . . . . .	58
Towing Hitch . . . . .	58
Electrical Connections for Towing . . . . .	58
Towing a Vehicle with Your Motorhome . . . . .	59
Safe Towing Tips . . . . .	59

## Chapter 6: Leveling and Slideout Systems

Leveling Systems . . . . .	61
Hydraulic Leveling Safety . . . . .	61
LCI Level-Up® Hydraulic Leveling System . . . . .	62
To Extend: . . . . .	62
To Retract: . . . . .	63
Manual Leveling with a Hydraulic Leveling System . . . . .	64
Zero Point Calibration . . . . .	64
Hydraulic Fluid Recommendations for LCI Leveling Systems . . . . .	64
Preventive Maintenance . . . . .	65
Troubleshooting . . . . .	65
LCI Basecamp Hydraulic Jacks for Class C Motorhomes . . . . .	66
Prior to Operation . . . . .	66
Operating the Hydraulic Jack System . . . . .	66
Touchpad Controller Functions . . . . .	67
Audible Alarms . . . . .	69
Preventative Maintenance Procedures . . . . .	70
Fluid Recommendation . . . . .	70
Electric Stabilizers . . . . .	70
Prior to Operating the Electric Stabilizers . . . . .	71

To Extend: . . . . .	71
To Retract: . . . . .	72
Manual Override Procedure . . . . .	72

Slideouts . . . . .	73
LCI In-Wall® Slideout Systems . . . . .	73
Extending the Slideout . . . . .	75
Retracting the Slideout . . . . .	75
Remote Operation . . . . .	75
Resynchronizing Slideout Motors . . . . .	75
Transit Bars . . . . .	76

## Chapter 7: Exterior Features and Components

Powered Entry Steps . . . . .	77
Operating Powered Entry Steps . . . . .	77
Awnings . . . . .	78
Patio Awnings . . . . .	78
Maintenance . . . . .	78
Entry Door Awnings . . . . .	79
Rear Awnings and Awning Pre-wire . . . . .	79
Storage Compartments . . . . .	80
Awning Lights . . . . .	80
Slideout Awnings . . . . .	80
Exterior Kitchen Unit . . . . .	81
Pull-out Exterior Griddle . . . . .	82
Pull-out 40 Quart, 12 Volt Cooler/Freezer . . . . .	84
Motorhomes with Rear Cargo Door . . . . .	85
Roof . . . . .	86
Inspections and TMC's Limited Warranties . . . . .	86
Factory-installed Roof-mounted Accessories . . . . .	86
Exterior Ladder . . . . .	86
LCI® On-The-Go Ladder Receiver . . . . .	87
Bicycle Rack . . . . .	87
Dealer / Owner-installed Roof and Sidewall Accessories . . . . .	87
Ramp Door and Patio Deck Enclosures . . . . .	88
Exterior Convenience Items . . . . .	89
Puddle Lights . . . . .	89
Pet Tether Bracket . . . . .	89
Entrance Door Grab Handle . . . . .	89
Storage Bay Cargo Trays . . . . .	89
Running Boards . . . . .	89

## Chapter 8: Interior Features and Components

Interior Lighting . . . . .	91
Appliances . . . . .	91
Cooktops and Ranges . . . . .	92
Refrigerators . . . . .	92
Microwave and Microwave/Convection Ovens . . . . .	93
Optional Appliances . . . . .	94
Dishwasher . . . . .	94
Clothes Washers and Dryers . . . . .	94
Electric Fireplace . . . . .	94
Central Vacuum System . . . . .	95
Entertainment Systems . . . . .	96
Dash Radio and Multimedia Receivers . . . . .	96
Televisions . . . . .	97
USB Charging Ports . . . . .	97
Viewing Over-the-Air or Cable TV . . . . .	98
Cable TV Hook-up . . . . .	98
Audio/Video Distribution . . . . .	99
Wi-Fi Connectivity: 4G System . . . . .	100
Wi-Fi Connectivity: 5G System . . . . .	100
Over the Air Roof-mounted Antenna . . . . .	101

## Chapter 9: Beds, Bunks, and Seating

Safety Notices . . . . .	103
Schwintek™ Powered Over-cab Bunks . . . . .	103
EuroLoft™ Over-Cab Bunks . . . . .	105
Electric Bed Lift Systems: Garage Area . . . . .	108
Class C Cab-over Bunks . . . . .	110
Bed Safety Systems . . . . .	110
Tips For Safe Elevated Bed Use . . . . .	110
Mid-ship Bunk Beds . . . . .	111
Telescoping Bunk Access Ladders . . . . .	112
Theater Seating . . . . .	113
Special Seating Controls and Features . . . . .	114
Sofa Bed Conversions . . . . .	115
Jack-knife Sofa . . . . .	115
Tri-Fold Sofa . . . . .	116
Murphy Beds . . . . .	117
Rear Bed with Cargo Storage Conversion . . . . .	119
Powered Rear Bed with Cargo Storage Conversion . . . . .	120
Dinette Bed Conversions . . . . .	121
Lagun® Table System . . . . .	122

## Chapter 10: Rapid Camp+® Multiplex Systems

Introduction . . . . .	123
Touchscreen Control Panels . . . . .	124
Switch Panels . . . . .	124
Main Electrical Control Boards . . . . .	125
Basic Multiplex Operation . . . . .	126
Remote Control . . . . .	126
Additional Multiplex Systems Information . . . . .	126
Firefly Multiplex Systems . . . . .	127
Screen Navigation: Lyra . . . . .	127
Firefly Screen Navigation: Mini Gas . . . . .	128
Floor Plan Selection . . . . .	129
Firefly Emprise Multiplex System . . . . .	130
Firefly Emprise Screen Navigation . . . . .	130
Firefly Phone App . . . . .	131
Vegatouch Mira and Eclipse Setup . . . . .	131
App Settings: . . . . .	133
BMPRO Multiplex Systems . . . . .	135
Touchscreen Controller Navigation . . . . .	135
BMPRO RVMaster System Diagram . . . . .	136
RVMaster Control Screens . . . . .	137
Control Panel Functions . . . . .	137
The RVMaster App . . . . .	138
RVMaster App Touchscreen Controls . . . . .	138
BMPRO Basic Multiplex System Operation . . . . .	138
Pairing to the RVMaster Node . . . . .	140
Remote Wall Switch (RVMaster Switch) . . . . .	140
Pairing a Wireless Switch to the RVMaster Node . . . . .	141
BMPRO Cloud . . . . .	141
Winegard WiFi Extender Set-up . . . . .	143

## Chapter 11: Electrical Systems

12-volt Electrical System . . . . .	145
Master Battery Switch . . . . .	146
Touch N' Go Control™:	
Dash Radio and Monitoring System . . . . .	147
Basic Operation . . . . .	147
Monitor Panels . . . . .	149
Multiplex Electrical System Monitoring . . . . .	150
Electrical Menu Screen . . . . .	151
Emergency Engine Start Switch . . . . .	152
Auxiliary Battery(ies), AGM or Lead-Acid Type . . . . .	153
Battery Maintenance . . . . .	153

Battery Storage (AGM/AGS) . . . . . 155

Battery Replacement . . . . . 155

Battery Charging . . . . . 155

    Charging by the Vehicle's Alternator . . . . . 155

    Charging by the AC-DC Converter . . . . . 156

    Charging by Solar Energy . . . . . 156

    Solar Charging, 10 amp Controller . . . . . 157

    Solar Charging, 30-amp Controller . . . . . 157

    Integrated Solar Charging Systems . . . . . 157

    Solar Panels . . . . . 158

    Solar Prep . . . . . 158

    Auxiliary Solar Panel Port . . . . . 159

Lithium-Ion Auxiliary Battery Installations, Class C . 160

    Lithium-Ion Battery Safety . . . . . 160

    Basic System Operation . . . . . 161

    Battery Charging Sources . . . . . 161

    Battery Monitoring . . . . . 162

    Lithium-Ion Auxiliary Battery Charging . . . . . 162

    Charging by the Vehicle's Alternator . . . . . 163

    Auxiliary Battery Charger:

    Redarc BCDC1240D . . . . . 164

    Additional Lithium-Ion System information: . . . 164

    Ford Transit Chassis Idle Speed Control . . . . . 165

120-volt Electrical System . . . . . 166

Shoreline Power . . . . . 166

    30-amp, 120-volt Shoreline Power Cord . . . . . 167

    50-amp, 240-volt Shoreline Power Cord . . . . . 167

    Powered Shoreline Cord Reel . . . . . 168

    Connecting to an External Power Source . . . . . 168

    Shore Power Wiring Configuration . . . . . 169

    Shoreline Cord Plug Adapters . . . . . 169

    Trickle Charging Batteries During Storage . . . . . 170

    Electrical Fault Protection . . . . . 170

    Shore Power Cord Maintenance . . . . . 170

    Power and Electrical Accessories . . . . . 170

Generator . . . . . 171

    Generator Safety . . . . . 172

    Generator Power Rating . . . . . 172

    Starting and Stopping Procedures . . . . . 173

    Starting with 'Dead' Battery(ies) . . . . . 173

Automatic Generator Start (AGS) . . . . . 174

    Fuel and Dual-Fuel Generators . . . . . 174

    AGS10 Automatic Generator Start . . . . . 175

    AGS15 Automatic Generator Start . . . . . 176

Automatic Transfer Switch . . . . . 176

Electrical Load Shedding . . . . . 177

DC to AC Inverter . . . . . 178

Inspection and Maintenance . . . . . 178

Power Load Center, 30-amp, All-in-one . . . . . 179

    120-volt Circuit Breaker Panel . . . . . 179

    Maintenance . . . . . 180

    12-volt Fuse Panel . . . . . 180

    AC to DC Converter . . . . . 181

Power Load Center, 50-amp . . . . . 183

    120-volt Circuit Breaker Panel . . . . . 183

    Maintenance . . . . . 184

    12-volt Fuse Panel . . . . . 184

    Converter . . . . . 184

    Multiplex System 12-volt Circuit Breaker Panel . . 184

Exterior 120-volt AC Outlet . . . . . 185

## Chapter 12: Propane System

Propane Gas Safety . . . . . 187

Introduction . . . . . 188

Traveling With Propane . . . . . 188

Propane Tank . . . . . 189

The Propane Gas Regulator . . . . . 190

    Preventing Propane Regulator Freeze-up . . . . . 190

Monitoring Propane Fuel Level . . . . . 191

General Instructions for Propane System . . . . . 192

    Main Gas Valve . . . . . 192

    Pilot Lights and Electronic Igniters . . . . . 193

    Disabling Electronic Igniters . . . . . 193

Propane Cooktops and Ovens . . . . . 193

    General Cooktop Operating Procedure . . . . . 194

    Gas Range and Oven Combination . . . . . 195

    2 or 3-burner Cooktops . . . . . 196

    Cooktop Care and Maintenance . . . . . 197

External Propane Hook-up Port . . . . . 197

Propane System Leak Test . . . . . 199

## Chapter 13: Water System

Freshwater System . . . . . 201

Potable Water Hose . . . . . 201

City Water Connection . . . . . 201

    Disconnecting City Water Source . . . . . 201

Freshwater Holding Tank . . . . . 202

    Freshwater Holding Tank Drain Valve . . . . . 202

Monitoring Holding Tank Levels . . . . . 203

Holding Tank Heaters . . . . . 204

Water Pump . . . . . 204

    Water Pump Strainer . . . . . 205

TABLE OF CONTENTS

Water Systems Panel . . . . . 205

    Valve Panels . . . . . 205

    Anderson Kantleak™ Water Valves . . . . . 205

    Nautilus Water Valves . . . . . 206

    Freshwater Filter . . . . . 206

Exterior Shower and Spray Port . . . . . 206

Water Heaters: Tank Type . . . . . 207

Water Heaters: Tankless . . . . . 208

    Anti-Freezing Protection . . . . . 209

Hydronic Heating Systems . . . . . 209

Troubleshooting All Water Heater Types . . . . . 210

Water Heater Bypass Valves . . . . . 210

Low Point Drain Valves . . . . . 210

The Water System in Cold Weather . . . . . 211

Sanitizing the Freshwater System . . . . . 211

    Sanitizing Procedure . . . . . 212

Winterizing the Water System . . . . . 212

    De-Winterizing the Motorhome . . . . . 213

Wastewater System . . . . . 215

Drainpipes . . . . . 215

    Vents . . . . . 215

Wastewater Holding Tanks . . . . . 215

Toilet . . . . . 215

Macerator Pump . . . . . 216

    Recirculation Mode . . . . . 216

Macerating Toilets . . . . . 217

    Operating the toilet . . . . . 217

    Care and Maintenance . . . . . 218

    Winterizing the Macerating Toilet . . . . . 218

Termination Valves . . . . . 219

Emptying Wastewater Holding Tanks . . . . . 220

Black Holding Tank Flush . . . . . 221

**Chapter 14: Heating and Cooling Systems**

Introduction . . . . . 223

Dash Heater and Air Conditioner . . . . . 223

    Control Panel . . . . . 223

Heating/Cooling with Multiplex Integration . . . . . 224

Wall-mounted Thermostats . . . . . 225

Ceiling and Ventilation Fans . . . . . 225

Cooling the Motorhome . . . . . 226

    Manual Controls for Roof-Mount Air Conditioners . . . . . 227

    Basic Air Conditioner Operation . . . . . 227

    Heat Pumps . . . . . 228

Heating the Motorhome . . . . . 228

Propane Furnaces . . . . . 228

Furnace Operation . . . . . 229

Furnace Care and Maintenance . . . . . 230

Hydronic Heating: Aqua-Hot 250 and 125 Series Systems . . . . . 231

Maintenance and Important System Information . . . . . 234

Sanitizing the Hot Water System . . . . . 235

Aqua-Hot Winterizing . . . . . 235

**Chapter 15: Care and Maintenance**

Requirements to Retain Warranty Coverage . . . . . 237

General Information . . . . . 237

Chassis Maintenance . . . . . 237

    Class A Motorhome Engine Access . . . . . 237

Molds and Mildew . . . . . 238

Condensation . . . . . 238

Cold Weather Usage . . . . . 239

Extended Stay Usage . . . . . 239

Exterior Care . . . . . 239

    Care of Fiberglass Surfaces . . . . . 240

    Painted Surfaces . . . . . 240

    Aluminum Surfaces and Extrusions . . . . . 240

    Cleaning and Maintaining Vinyl Graphics . . . . . 240

Roof . . . . . 242

    Normal Cleaning . . . . . 242

    Roof Vents and Vent Hoods . . . . . 242

    Antennas, Satellite, and Wi-Fi Extenders . . . . . 242

Windows and Doors . . . . . 243

Storage Compartments . . . . . 243

Maintenance Access Panels . . . . . 243

Seals, Sealants, and Adhesives . . . . . 244

Slideout Maintenance . . . . . 244

Storing the Motorhome . . . . . 245

    Winter Storage . . . . . 245

Additional Care and Maintenance Information . . . . . 246

Maintenance Schedule . . . . . 247

**Index**

A - Z . . . . . 253

*This page is intentionally blank*

# Chapter 1: Introduction

## About This Owner's Manual

This Owner's Manual is intended to introduce you to the basic features of your new motorhome. It is not intended for use as a service manual, nor does it provide complete operational instructions. It is a guide to help you become familiar with the safe operation and use of your motorhome. It is general in nature, so the illustrations, descriptions, features, and components, included in this manual may be standard or optional equipment, or due to design changes or other circumstances, may not be available on your particular TMC Class A or Class C motorhome. Please read and save an electronic copy of this manual and your TMC Warranty Guide to your tablet or laptop for needed referencing.

Specific information for the systems and components of your motorhome is provided through other TMC publications, media, and services. These resources include: TMC on-line Owners Resource service, which provides owners with access to component manufacturers' instructional booklets and other important documents, TMC-produced how-to videos, and through TMC's Customer Care representatives, who are available 24/7 to answer your questions and assist with your questions and concerns.

*NOTE: Throughout this manual, the terms 'house,' 'coach,' or 'RV' are used to describe the living quarters, components, systems and features of your motorhome, designed, built, and installed by Thor Motor Coach. While the term 'chassis' or 'vehicle' refers to the motorized portion of your motorhome, designed, built, and supplied by the chassis manufacturer (Ford, G-M, Mercedes-Benz, Freightliner, RAM, and possibly others).*

## TMC Warranty Guide

The Thor Motor Coach Limited Warranty and the Thor Motor Coach Structural and Lamination Limited Warranty are printed in your TMC Warranty Guide. The TMC Warranty Guide also contains your TMC Product Warranty Registration Form and other important information.

Please review all warranties, warranty restrictions, limitations, and actions needed to keep warranties in-force with your dealer. If you have questions regarding TMC Warranty coverage, contact TMC Customer Care.

Electronic copies of the latest versions of TMC's Owner's Manuals and the Thor Motor Coach Warranty Guide are always available from the Thor Motor Coach website:

[thormotorcoach.com/owners/owners-manuals](http://thormotorcoach.com/owners/owners-manuals)

## Chassis Manufacturer's Owner's Manual and Warranty

Supplied by the manufacturer of your motorhome's chassis, the manufacturer's owner's manual (or operating guide) contains important safety, operation, maintenance, and warranty information pertaining to the motorized vehicle portion of your motorhome. Instructions for registering your applicable warranty using the chassis manufacturer's Delayed Warranty Start Form are printed in the TMC Warranty Guide.

Before operating your motorhome, read these instructions carefully and familiarize yourself with the vehicle's operation and safety features. For your own safety and a longer vehicle life, follow the operating, maintenance instructions and warning notices the manufacturer provides in the owner's manual. Disregarding these instructions may result in damage to the vehicle, the environment, or result in personal injury.

Always keep a copy of the manufacturer's owner's manual in your motorhome for reference. Electronic copies are usually available through the chassis manufacturer's website.

## TMC Owner's Packet

Included with your new motorhome is the TMC Owner's Packet. It contains important information pertaining to the safe operation, care, maintenance and warranties of the factory-installed systems and components of your motorhome. Please read, follow, and retain for reference the information contained in your TMC Owner's Packet.



TMC Owner's Packet

*NOTE: A list of component suppliers is available through the on-line Thor Motor Coach Owners Resource Service.*

## Contact TMC Customer Care

Contact your selling dealer or TMC's Customer Care for answers to any question you may have regarding your motorhome, its operation, care, maintenance, service, or TMC warranties, warranty coverage, and warranty service or repairs. TMC Customer Care representatives are available 24 hours a day, 7 days a week at:

Telephone (toll free): 877-855-2867

Email: [wsupport@tmcrv.com](mailto:wsupport@tmcrv.com)

You can also contact TMC's Customer Care by filling out and submitting the on-line form located here:

[thormotorcoach.com/company/contact-us](http://thormotorcoach.com/company/contact-us)

If you are contacting TMC's Customer Care by email or on-line form, response times are within 1 to 2 business days. You must include your name, phone number, a valid email address, along with your 17-digit Vehicle Identification Number (VIN) and a brief description of your inquiry.

## Online Customer Support

A good working knowledge of your motorhome and how to care for it will help you enjoy many years of satisfied motorhome ownership. Specific operational and maintenance instructions for the systems and factory-installed components of your motorhome are not included in this manual, however, more detailed information associated to your motorhome is available on-line through the Thor Motor Coach website:

[thormotorcoach.com/owners](http://thormotorcoach.com/owners)

From the web page listed above, click on the icons that will direct you to resources such as: TMC Owner's Manuals, authorized TMC Service Center Locator, TMC Owners Support, First Time Owners Guides, and other useful and informative information.

## TMC Owners Resource

Additionally, TMC motorhome owners have access to a complimentary on-line service that provides important information pertaining to the operation, care, and maintenance of your TMC Class A, Class B, or Class C motorhome in greater detail than what is included in this owner's manual.

This service provides appliance and component instructional manuals, quick-start guides, and links to How-to videos associated to the factory-installed systems and components unique to your motorhome. Documents are provided in a viewable, printable, and downloadable .pdf format. Filter and search features within the Owner's Resource Document System help you quickly find the reference information you need. Visit your TMC Owners Resource account often as updates and new information are continually being introduced.



To access the TMC Owners Resource service, simply click on the OWNERS tab located on the main page of the TMC website (thormotorcoach.com), then click on the Owners Resource icon. You will be directed to a page where you can Sign up (creating a new account), or Login to your existing account.

To create a new account, you simply enter your 17-digit Vehicle Identification Number (VIN), enter your contact information, and create a user password. This service is available to owners of new and pre-owned TMC motorhomes built since 2010.

Accessing the TMC Owners Resource information can be done with a laptop or desktop computer, tablet, or smartphone. However, whether creating a new account or accessing an existing account, TMC recommends using a computer (laptop or desktop) or tablet for improved performance and ease of document and video viewing.

### Link to TMC Owners Resource

Point your QR Code reader at the image below to go directly to the TMC Owners Resource Login and Sign-up page.



### Need a French Language Owner's Manual?

The QR Code above also links to the TMC website page where digital copies of the TMC French Language Owner's Manuals and Warranty Guides can be opened and downloaded.

*NOTE: It is not necessary to create a TMC Owners Resource account to download English or French Language Owner's Manuals and copies of the TMC Limited Warranties. These documents are available directly from the TMC website.*

## TMC Basic Operation Guides

Operational and maintenance information is also available through TMC's Basic Operation Guides (also referred to as Quick-Start Guides). Viewable and downloadable from your TMC Owner's Resource account, these brief and informative guides (.pdf format) are a good resource for quick information on a variety of topics, ranging from:

- Basic camp set-up,
- Electrical systems and devices,
- Water systems,

- Appliance operation,
- Leveling systems and slideouts,
- Towing with your motorhome,
- Care and maintenance,
- Winterizing and storage, and many more.

Filter and search features within the Owner's Resource Document System help you quickly find the reference information you need.

## TMC System Guides

A good source of operational and maintenance information pertaining to TMC motorhomes is available through TMC's System Guides. System Guides are intended to inform TMC motorhome owners about the systems and components installed on their motorhome. System Guides are continuously updated as new features and components are added to the TMC model line-up. System Guides are available as viewable, printable, and downloadable .pdf documents from your TMC Owners Resource account.

## TMC Instructional Videos

TMC provides informational 'how-to' videos through the Thor Motor Coach YouTube channel. This video library is constantly being updated and includes helpful information regarding the operation and maintenance of the systems and components installed on your motorhome:

[www.youtube.com/user/ThorMotorCoach](http://www.youtube.com/user/ThorMotorCoach)

For your convenience, instructional videos are also listed and linked from your TMC Owners Resource account.

## Freightliner 24/7 Direct App

Owners of TMC Motorhomes built on a Freightliner chassis are encouraged to sign-up for Freightliner's My 24/7 Direct App. Freightliner is the only chassis builder to offer around-the-clock toll-free support directly from the manufacturer for the life of your motorhome's engine, drivetrain, and chassis; not just the warranty period. Available for iPhone and Android devices, this smartphone app provides owners with many useful benefits:

- 24/7 roadside assistance,
- OwnerHQ used to locate service dealers,
- Store and share maintenance logs,
- Access service checklists,
- Owner and maintenance manuals,
- Dash light and warning descriptions, and more.

And Freightliner factory-direct phone support is always just a click away.

## Thor Diesel Club

If you are an owner of a Class A or Super C diesel motorhome manufactured by Thor Motor Coach and built on a Freightliner chassis foundation, you are eligible for membership to the Thor Diesel Club. Members discover a whole new level of camaraderie, while increasing their knowledge of their TMC motorhome and the RV lifestyle.

The Thor Diesel Club is an independently owned and operated entity that uses the Thor name under a license agreement. The Thor Diesel Club is not a principal or agent of Thor Motor Coach.

For more information on how you can become a Thor Diesel Club member, please contact:

Mailing Address: *Thor Diesel Club*  
5753 Hwy 85N #557  
Crestview, Florida 32536

Website: <https://thordieselclub.com>

Email: [thordieselclub@gmail.com](mailto:thordieselclub@gmail.com)

*NOTE: If you have purchased a new, previously untitled Class A diesel motorhome or Super C diesel motorhome built on a Freightliner chassis, Thor Motor Coach will pay for your first year of membership to the Thor Diesel Club. Simply visit the website listed below, fill out the form, and submit your request.*

*If you have a previously owned TMC Class A diesel motorhome or Super C diesel motorhome built on a Freightliner chassis, you may still join by visiting the Thor Diesel Club website:*

[thormotorcoach.com/owners/thor-diesel-club/](http://thormotorcoach.com/owners/thor-diesel-club/)

## Important Disclaimers:

Features, items, and components described and depicted within this owner's manual may not be available as standard or optional equipment on the motorhome brand and floor plan you purchased. Features, items, and components described and depicted within this publication that are not included or part of your motorhome, does not mean that these features, items, or components are intentionally or unintentionally missing from your motorhome, or that Thor Motor Coach has an obligation to install them on or within your purchased motorhome.

Illustrations within this and other Thor Motor Coach documents and publications may include personal property items (e.g., clothing, housewares, accessories, indoor and/or outdoor furnishings, camping and/or sports equipment) and are shown for demonstration purposes only. The inclusion of these items in photographs, videos, or written descriptions does not indicate these items are standard equipment or available as optional equipment with the purchase of Thor Motor Coach motorhomes.

*This page is intentionally blank*

## Dealer's Responsibilities

Your selling dealer is responsible for inspecting both factory and dealer installed components for proper operation. This is referred to as a pre-delivery inspection (PDI).

Your selling dealer is required to provide a thorough and complete walk-through demonstration and perform a test drive with you. The demonstration should provide you with a good understanding of your new motorhome's operation, safety features, and maintenance requirements.

At the time of purchase, your selling dealer should discuss this Owner's Manual, the Owner's Packet, the vehicle manufacturer's owner's manual, and the TMC Warranty Guide, including TMC's Limited Warranties. Their presentation should include assisting you with completing all warranty cards and registrations, and reviewing all component information, including warranty, safety, operation, and maintenance information relating to your new motorhome.

Your selling dealer is required to complete and return the TMC Product Warranty Registration Form (located in the TMC Warranty Guide) to Thor Motor Coach within 15 days of delivery of your motorhome to you. **The Thor Motor Coach Limited Warranty is activated on the date of delivery of the new motorhome to its new owner(s).**

*NOTE: Failure to file the Product Warranty Registration Form with TMC will not affect your rights under the applicable TMC limited warranty as long as you can present proof of purchase and proof of delivery date to TMC, but it can cause delays in obtaining the benefits of the applicable TMC limited warranty, and it may inhibit any servicing facility's ability to provide proper repairs and/or parts replacement.*

All agreements between your selling dealer and TMC are for the benefit of the selling dealer and TMC only. Third parties, including retail buyers of motorhomes, are not third beneficiaries of the Agreements, nor may they enforce the terms of the Agreements.

## Consumer's Responsibilities

You, as the owner/operator of the motorhome, are responsible for providing regular and proper service and maintenance of your motorhome as outlined in this TMC Owner's Manual, the TMC Warranty Guide, the Owner's Packet, TMC's On-line Customer Support, the vehicle manufacturer's owner's manual, and all individual component suppliers' information. Be sure to have service performed in a timely manner to help avoid situations possibly caused by neglect or abuse that are not covered under

warranty. Thor Motor Coach Limited Warranties do not cover expenses incurred due to routine service and normal maintenance.

If you have questions regarding warranty coverage, contact TMC Customer Care at:

877-855-2867

At the time of purchase:

- Inspect the entire motorhome during the test drive and pre-delivery inspection (PDI) and note any issues in writing on the TMC Product Warranty Registration Form. Ask any questions you may have before leaving the selling dealership.
- Read and indicate your acceptance of TMC's terms and conditions of the Thor Motor Coach Limited Warranty by signing, along with a representative of the dealership, the TMC Product Warranty Registration Form.
- Complete and return all applicable component warranty cards and registrations.
- Familiarize yourself with your new motorhome, its systems, features, and safe operational procedures. Follow all TMC, chassis manufacturer, and all individual component suppliers' instructions regarding safety, operation, and maintenance of their respective products.

Electronic copies of Thor Motor Coach Owner's Manuals and Limited Warranties applicable to your motorhome are available from the Thor Motor Coach website:

[thormotorcoach.com/owners/owners-manuals](http://thormotorcoach.com/owners/owners-manuals)

NOTES:

- Failure to properly maintain your motorhome could result in loss of warranty coverage.
- Your motorhome is not designed, nor intended, for permanent housing. Use of your motorhome for long term or permanent occupancy may lead to premature deterioration of its structure, interior finishes, fabrics, carpeting, and/or window treatments, etc.
- Damage and/or deterioration due to long term occupancy is not considered normal and may under the terms of the warranty constitute misuse, abuse, or neglect, and therefore void certain warranty protections.

## California Consumers Notice:

Thor Motor Coach has elected to follow the procedures described in CA Code of Civil Procedure, Section 871.20, et seq., regarding pre-litigation notice requirements for consumer claims brought pursuant to the Song-Beverly Consumer Warranty Act. To comply with these pre-litigation notice requirements (described at CA Code of Civil Procedure, Section 871.24), written notice can be sent to Thor Motor Coach, to the attention of Consumer Affairs - either via email or by certified or registered mail. Please include an address where a confirmation receipt can be sent to you.

## Consumidores de California:

Thor Motor Coach ha elegido seguir los procedimientos descritos en el Código de Procedimiento Civil de California, Sección 871.20, y lo siguiente, con respecto a los requisitos de notificación previa al litigio para reclamos de consumidores presentados de conformidad con la Ley de Garantía del Consumidor Song-Beverly. Para cumplir con estos requisitos de notificación previa al litigio (descritos en el Código de Procedimiento Civil de California, Sección 871.24), se puede enviar una notificación por escrito a Thor Motor Coach, a la atención del departamento de Asuntos del Consumidor (Consumer Affairs), ya sea por correo electrónico o por correo certificado o registrado. Por favor incluya una dirección donde se le pueda enviar un recibo de confirmación.

Email (Correo electrónico): [wsupport@tmcrv.com](mailto:wsupport@tmcrv.com)

Mailing Address: **Thor Motor Coach**  
(Dirección postal) **Attn: Consumer Affairs**  
**P.O. Box 1486**  
**Elkhart, IN 46515-1486 USA**

## Change of Address or Ownership

The 'National Traffic and Motor Vehicle Safety Act of 1966' in the United States, and Transport Canada require manufacturers to be able to contact vehicle owners when a correction of a safety-related defect or noncompliance issue becomes necessary.

To enable TMC to contact you, the current owner, with important vehicle product and safety updates, including vehicles with expired warranty coverage, please update your vehicle-related ownership information by contacting TMC by **faxing** to the attention of Registrations:

574-294-3618

or, by emailing: [registrations@tmcrv.com](mailto:registrations@tmcrv.com)

Include the following:

- Your legal name;
- Your current mailing address (include your prior mailing address for change of address notifications);
- Your telephone number (home and/or cell);

- Your email address;
- Your vehicle's 17-digit vehicle identification number (VIN);
- Your vehicle's TMC serial number;
- Legal proof of purchase (e.g., a legible copy of your bill of sale or insurance card);
- Current motorhome odometer reading.

## Vehicle Identification Labels

The vehicle identification number (VIN) and the TMC serial number is listed on a label affixed to the inside of the driver's door jamb of Class B and C motorhomes. For Class A motorhomes, a VIN label is affixed to the inside panel, just left of the driver's seat. Please refer to the chassis manufacturer's owner's manual for the location of the 17-digit chassis VIN tag.

## How to Obtain Assistance

Should a question or concern arise regarding your motorhome, the first step is to contact your selling dealer. Their sales, service, and parts professionals will be glad to assist you.

You can also contact a TMC Customer Care representative 24 hours a day, 7 days a week. Telephone (toll free):

877-855-2867

If you leave a voice-message, please include your name, your telephone number, your VIN, and briefly describe the purpose of your inquiry. You will receive a returned phone call from a TMC Customer Care representative as soon as possible.

Your selling dealer and/or your TMC Customer Care representative should be able to solve any questions or concerns you have regarding your motorhome. However, if their combined efforts are not satisfactory, please send a letter describing the circumstances to:

*Thor Motor Coach*  
*Attn: Customer Care*  
*P.O. Box 1486*  
*Elkhart IN 46515-1486*

Include the following:

- Your selling dealer's name, address, and phone number;
- Your legal name, current mailing address, phone number, and email address;
- Your vehicle's 17-digit vehicle identification number (VIN);
- Your vehicle's TMC serial number;
- Current motorhome odometer reading;
- If applicable, include the individual component supplier's name, part description, model number, and serial number.

## Suggestions for Obtaining Service

The following suggestions will help ensure your selling dealer provides the level of service you expect.

Contact your dealer at once:

Service appointments are made based on each dealer's service schedule, so contact your dealer as soon as possible to have service or repairs performed.

Prepare for the appointment:

If warranty-covered work is being performed, have the following documentation available:

- TMC Warranty Guide;
- Applicable component warranties;
- Component serial numbers;
- Vehicle identification number (VIN);
- Vehicle serial number.

All work to be performed may not be covered by the TMC Limited Warranty or component manufacturer's warranties. Discuss warranties and possible service charges with the dealer's service professionals before authorizing service work.

Prepare a list:

Provide your dealer with a written list of specific repairs needed. It is important that you provide the vehicle's repair history to the dealer's service professionals. Keep a maintenance and service log for your vehicle and have it available for your dealer to review.

Be reasonable with your requests:

If you need your motorhome returned by a specific date and time, discuss the situation with the dealer's service professionals and list your repair items in order of priority. This may include making a second appointment for work not completed or a list of parts that the dealer may need to obtain prior to performing service work.

Do not expect access to the service area:

Please do not be offended if you are not allowed in the service area while the service work is being performed. Some insurance requirements forbid admission of customers to service areas.

Inspect the work performed:

Along with the service manager or representative, inspect the service or repair work when you pick up your motorhome. Notify the dealer's service professionals immediately of any dissatisfaction with the performed service work. If you cannot return the vehicle immediately for repairs or corrections, make an appointment as soon as possible.

Please be aware that all service shops require notification of any issues with their repairs within a specified time limit. Make sure you are familiar with the repair facilities policies.

*NOTE: Please refer to your TMC Factory Service Appointment Form for important additional information.*

## Emergency, Weekend, or After Business Hours Assistance

In an emergency, if an authorized TMC dealer is not located nearby, please contact your selling dealer for assistance. If your selling dealer is closed, contact TMC Customer Care at:

877-855-2867 (available 24/7)

For warranty repair authorization and for emergency weekend or after-business-hours repair assistance, see How to Obtain Assistance, in this section.

## Service or Warranty Repair from Thor Motor Coach

If your motorhome needs service repair, and your dealer recommends that the repairs be made at the TMC Factory Service Center, your motorhome may be returned to TMC with the following guidelines:

- You, the current motorhome owner, or your referring dealer must make a confirmed appointment prior to dropping off your motorhome.
- You are responsible for all transportation costs and hotel accommodations; please be prepared accordingly.
- Unless prior approval has been obtained from the TMC Factory Service Center, all personal items must be removed from the area where you are requesting service repair and the refrigerator emptied. TMC is not responsible for any loss of valuables, stolen property, or loss and/or spoilage of food items.
- Your motorhome holding tanks must be emptied and rinsed. TMC has a dumping station available for customer use.
- The propane system and all electrical systems must be shut down and turned OFF. TMC is not responsible for discharged batteries or loss of propane.
- During the appropriate season, please ensure your motorhome is winterized.
- You must retake possession of your motorhome within 7 business days of TMC notifying you that the repairs have been completed; otherwise, unless a longer storage time has been previously agreed to in writing by TMC, you may be liable for additional daily storage fees payable to TMC.

## Warranty Service Availability Notice

The availability and scheduling of warranty services are subject to various factors and are not guaranteed. Warranty repairs or service may be delayed due to, without limitation, the availability of original or replacement parts, the use of substitute or functionally equivalent parts, supply chain constraints, regulatory requirements, or other conditions that may impact the performance of warranty obligations. Such delays may be more prevalent in the Canadian market; however, similar limitations may also apply to consumers in the United States. Thor Motor Coach shall not be liable for any delay in the performance of warranty service arising from these or related circumstances.

## Replacement Parts

Please contact your selling dealer for assistance in obtaining replacement parts and/or accessories. Parts can also be obtained directly from TMC by calling toll free:

877-855-2867, then choose the Parts Prompt

Inquiries about obtaining replacement parts can be emailed to: [parts@tmcrv.com](mailto:parts@tmcrv.com)

If the original part is no longer available, TMC will make every effort to suggest or provide an appropriate substitute.

## Website Usage Disclaimers

*Thor Motor Coach (TMC) hereby disclaims and sets forth as follows:*

### Website Disclaimer of Warranty:

The services, information and materials on websites listed in this manual are provided 'AS IS,' and TMC shall have absolutely no liability whatsoever in connection with these website services, information, external links, or third-party links on these websites. Your use of these websites is at your own risk. TMC shall have no liability whatsoever for any errors, omissions, or inaccuracies in the information regardless of how caused or for delays or interruptions in delivery of the information: or any decision made, or action taken or not taken in reliance upon the information furnished.

TMC accepts no responsibility or liability whatsoever with regards to information on these websites, as the information is meant to be of a general nature only and is not intended to address the specific circumstances of any particular individual or entity.

The information provided is not necessarily comprehensive, complete, accurate or up to date; the information is sometimes linked to external sites over which TMC has no control and for which TMC assumes no responsibility: TMC shall have no liability for any loss or injury caused, in whole or in part, by its actions, omissions or negligence, or for any contingencies beyond its

control in procuring, compiling or delivering any information. The information is not professional, nor does it comprise legal advice (if you need specific advice, you should always consult a suitably qualified professional).

### Disclaimer of Endorsement:

Any reference within external or third-party links to any specific commercial products, process or service by trade name, trademark, manufacturer or otherwise, does not constitute or imply it's endorsement, recommendation or favoring by TMC. The appearance of external or third-party links does not constitute endorsement by TMC of the linked websites or the information, products or services contained therein. TMC does not exercise any editorial control over the information you may find at these locations. External or third-party links may be provided for the convenience of the users of that website. TMC is not responsible for the availability or content of these external or third-party sites and does not endorse, warrant, or guarantee any products, services, information, centers, or schools described or offered at these links.

## Thor Motor Coach® Recreational Vehicle Privacy Notice

Your Thor Motor Coach RV contains systems which allow Thor Motor Coach to collect information about your recreational vehicle, how it is used, and where it is located, and your Internet connection established through the RV's embedded equipment. Thor Motor Coach may also collect information about you, your RV, and how and where it is used through devices, applications, and services you use in connection with your Connected RV.

Some data, including location information, may be transmitted to Thor Motor Coach (directly or through its service providers) via the included Winegard modem/router whenever that device is connected to the Internet (via Wi-Fi, cellular connection, or other means). This data may be transmitted regardless if your RV is parked or in motion.

Thor Motor Coach collects, uses, stores, and/or shares this data for a number of reasons, including providing assistance to you, troubleshooting, improving its products, and to offer you products and services which may be of interest to you. For more information and updates about what information Thor Motor Coach may collect, how we use, store, and share it, and how we protect it, please review the Thor Industries Privacy Policy:

[www.ThorIndustries.com/privacy-policy/](http://www.ThorIndustries.com/privacy-policy/)

and the Winegard Company Privacy Policy:

<https://rvhalo.com/info/privacy-policy/>

You may prevent sharing by disconnecting the Winegard modem/router from the electrical power source. Note: if you disable or limit

information sharing with Thor Motor Coach or its partners, certain product features may not work or may have limited functionality.

Thor Motor Coach RVs with connectivity features are intended for use in the United States and Canada only. Data and privacy protection laws where you use the RV may impose certain responsibilities on you with respect to your use of RV and related services. You are responsible for ensuring you comply with such laws when you use the RV and related services. You are responsible for informing those you permit to use or occupy your RV (with or without you, and including anyone to whom you loan, give, or sell the Connected RV) how data related to their use of the RV may be collected and processed.

If your Thor Motor Coach RV is equipped with a Sirius Radio receiver, TMC will forward your vehicle and contact information to Sirius. They will use this information to activate your subscription.

If you have any questions about this privacy notice or our privacy practices, please contact Thor Motor Coach Customer Care at:

877-855-2867

## Chassis Information Notice

TMC Class A motorhomes built on the Ford F-53 and E-Series chassis may be equipped with a modem and roof-mounted antenna. This device (installation required by the chassis manufacturer) is used to access important vehicle diagnostic information and may include other useful features. Refer to your Ford Owner's Manual, contact your Ford dealer, or visit Ford's website for system details and Ford's Vehicle Privacy Policy.

## Reporting Safety Defects

### In the United States

If you believe that your recreation vehicle has an alleged defect that could cause a crash or cause injury or death, you should immediately inform the National Highway Traffic Safety Administration (NHTSA) and Thor Motor Coach.

If NHTSA receives similar complaints, it may open an investigation, and if it finds that a safety defect exists in a group of vehicles, it may order a recall and remedy campaign. However, NHTSA cannot become involved in individual problems between you, your selling dealer, or Thor Motor Coach.

For additional information, go to the NHTSA website at:

<https://www.nhtsa.gov/>

To contact NHTSA by telephone:

888-327-4236

TTY: 888-275-9171

A NHTSA representative will record your complaint information.

To contact NHTSA by mail:

Office of Defects Investigations/CRD  
NVS-216  
1200 New Jersey Ave. SE  
Washington, DC 20590 USA

To contact Thor Motor Coach by telephone:

877-855-2867

To contact Thor Motor Coach by mail:

Thor Motor Coach  
Attn: Customer Care  
P.O. Box 1486  
Elkhart, IN 46515-1486 USA

### In Canada

If you believe your recreation vehicle has an alleged safety defect, you should contact Transport Canada and Thor Motor Coach to report your safety concerns.

Transport Canada website:

<https://www.tc.gc.ca/recalls>

To contact Transport Canada by telephone:

Toll Free: 800-333-0510 (in Canada)

or: 819-420-4300 (Ottawa-Gatineau area or International)

To contact Transport Canada by mail:

Transport Canada - ASFAD  
330 Sparks Street  
Ottawa, Ontario  
K1A 0N5 Canada

To contact Thor Motor Coach by telephone:

877-855-2867

To contact Thor Motor Coach by mail:

Thor Motor Coach  
Attn: Customer Care  
P.O. Box 1486  
Elkhart, IN 46515-1486 USA

*This page is intentionally blank*

## Safety Alerts

Thor Motor Coach uses the following safety symbols and signal words to warn of possible safety concerns and to provide information to help prevent personal injury and/or damage to the motorhome:

*NOTE: Provides important information and useful tips.*



**This is the safety alert symbol. It is used to alert users to potential personal injury hazards. Obey all safety messages that follow this symbol to avoid possible injury or death. This symbol may be used in conjunction with the following signal words and with a color that corresponds with the associated safety label.**

### **DANGER**

**DANGER** indicates an imminently hazardous situation that, if not avoided, will result in death or severe injury. This alert information is limited to the most extreme situations.

### **WARNING**

**WARNING** indicates a potentially hazardous situation that, if not avoided, may result in death or severe injury.

### **CAUTION**

**CAUTION** indicates an imminently hazardous situation that, if not avoided, may result in minor or moderate injury. It may also be used to alert against unsafe practices.

### **NOTICE**

**NOTICE** indicates a potential situation that, if not avoided, may result in property damage or damage to your motorhome.

## Safety Labels

### **WARNING**

**DO NOT remove Safety Labels from RV. If labels are damaged or illegible, contact Thor Motor Coach Customer Care for replacements.**

**Phone (Toll Free): 877-855-2867, or**  
[thormotorcoach.com/company/contact-us](http://thormotorcoach.com/company/contact-us)

There are safety decals and vehicle information labels affixed throughout the motorhome. Read and follow the instructions listed on all decals, labels, or data plates before and during operation and during storage of the motorhome.

*NOTE: Replacement safety labels can be obtained from your selling dealer's parts department or through TMC's Customer Care.*

## Fire Safety

### **DANGER**

The petrochemicals use in vehicles and equipment powered by internal combustion engines and placed or transported in recreation vehicles may cause carbon monoxide poisoning or asphyxiation, which could result in death or severe injury.

The flammable liquids (fuel vapors) used to power these items can cause a fire or explosion, which can result in death or severe injury.

#### TO REDUCE RISK:

1. **DO NOT** ride in the vehicle storage area when vehicles, equipment, or fuel are present.
2. **DO NOT** sleep in the vehicle storage area when vehicles, equipment, or fuel are present.
3. Close doors and windows in walls of separation (if installed) when any vehicle, equipment, or fuel is present.
4. Run fuel out of engines ~~or stored~~ of vehicles and equipment after shutting off fuel at the tank.
5. **DO NOT** store, transport, or dispense fuel inside this vehicle (motorhome).
6. Open the windows, openings, or air ventilation systems provided for venting the transportation (storage) area when vehicles, equipment, and fuel are present.
7. **DO NOT** operate propane appliances, pilot lights, or electrical equipment when motorized vehicles, equipment, or fuel are present.

** DANGER****NO SMOKING**

Before dispensing fuel, turn off all engines, fuel-burning appliances, and their igniters (see operating instructions).

**DO NOT dispense fuel within 20 feet (6.1 meters) of an ignition source.**

**Can cause ignition of flammable vapors, which can lead to a fire or explosion and result in death or severe injury.**

** DANGER**

All pilot lights, appliances, and their igniters (see operating instructions) shall be turned off before refueling of motor fuel tanks and/or propane containers.

**Can cause ignition of flammable vapors, which can lead to a fire or explosion and result in death or severe injury.**

** WARNING**

**DO NOT attempt to use water to put out an electrical or oil-based fire. Water can spread some types of fire, and electrocution is possible with an electrical fire.**

Awareness and adherence to fire safety is an important part of being a responsible motorhome owner/operator. Make sure that everyone traveling in the motorhome is familiar with the location of exits, including emergency exit egress windows. By following these basic rules of fire prevention, the risk of a fire can be significantly reduced:

- **NEVER** store or transport flammable liquids inside the motorhome.
- Keep cooking surfaces clean of cooking oils and other food spills.
- **NEVER** use a flammable liquid or substance as a cleaning agent or solvent.
- **NEVER** leave a lit cooktop or cooking food unattended.
- Keep flammable materials away from open flames.
- **NEVER** smoke in bed; and when smoking, always use an ashtray.
- **NEVER** allow children to play with propane or electrical equipment.
- **NEVER** use an open flame as a source of illumination.
- **NEVER** leave burning candles, smoking materials, or other open flames unattended.
- Promptly repair faulty or damaged wiring and electrical components
- **NEVER** overload electrical circuits, outlets, or extension cords.
- Locate and repair propane gas leaks immediately.
- **DO NOT** allow rubbish and trash to accumulate.
- Spray fabrics annually with a flame retardant.
- Check smoke and LP/CO detectors regularly.
- Check expiration dates on fire extinguishers and detectors and replace on or before expirations.
- Make an emergency escape plan and practice it regularly.
- Make sure doors and windows open easily and stay clear of clutter so that emergency access is not blocked.
- Ensure emergency contact information is up to date.
- **NEVER** use appliances with frayed or damaged electrical cords or missing ground pins.
- **DO NOT** pack travel items closely around electrical devices or heat sources.

**IMPORTANT! IF A FIRE IS DETECTED, ALWAYS FOLLOW THE BASIC RULES OF FIRE SAFETY:**

1. **Evacuate everyone (including pets) from the motorhome immediately!**
2. **After everyone is clear, check the fire to determine if it can be easily put out. If the fire is too large, or the fire is fuel fed, stay clear of the motorhome and have the fire department manage the emergency.**
3. **If it can be safely done, without risking bodily harm or injury:**
  - a. **Turn OFF the main propane gas valve at the propane tank;**
  - b. **Switch the 120-volts AC main circuit breaker to the OFF position;**
  - c. **Disconnect the shoreline power cord from the shore power receptacle;**
  - d. **Turn OFF the generator (if equipped);**
  - e. **Disconnect the negative battery cable(s) at the auxiliary battery and chassis battery.**
4. **DO NOT attempt to use water to put out the fire. Water can spread some types of fire (grease or oil), and electrocution is possible with an electrical fire.**
5. **Always have faulty or damaged wiring, electrical components, propane tanks, valves, pipes, gas, and electrical appliances inspected by a certified RV repair technician and repaired immediately.**

## Fire Extinguisher

### **⚠ CAUTION**

Always replace the fire extinguisher with a similar Class B-C type.

- Fire extinguishers must be replaced after any use, even if used briefly.
- Fire extinguishers have an effective service life. Replace expired fire extinguishers.

Fire extinguishers are classified and rated by fire type; A, B, and C. These classifications identify the kinds of fires or burning materials they are designed to extinguish:

**Class A:** Solid materials such as wood, paper, cloth, rubber, and some plastics.

**Class B:** Liquids such as grease, cooking oils, gasoline, kerosene, or other flammable liquids.

**Class C:** Electrical such as electrical wires or other live electrical equipment.

A dry-chemical fire extinguisher has been installed by the entrance door. It is suitable for extinguishing small fires of the Class B or C type only.



Typical Class B-C fire extinguisher

#### Operation:

For information on how to use the installed fire extinguisher, refer to the fire extinguisher manufacturer's owner's manual or the label affixed to the side of the fire extinguisher.

#### Inspection:

Inspect the extinguisher at least once a week (more frequently if it is exposed to weather or possible tampering). This should also be done before beginning a vacation or during an extended trip.

#### Replacement:

The fire extinguisher must be replaced following the fire extinguisher manufacturer's owner's manual instructions, and/or expiration date listed on the label affixed to the side of the fire extinguisher.

*NOTE: Know the location of the fire extinguisher installed in your motorhome and become familiar with its operation.*

## Smoke Alarm

### **⚠ WARNING**

Test smoke alarm operation if the vehicle has been in storage, before each trip, and at least once per week while in use.

Failure to do so could result serious injury or death.

### **⚠ WARNING**

This smoke alarm may not alert the hearing impaired. Special alarms with flashing strobe lights are recommended for the hearing impaired.

### **⚠ CAUTION**

Ensure the smoke detector and alarm is always kept in good working order. Test this device regularly and immediately replace if it is not functioning properly.

The smoke detector operates on an internal battery. Immediately replace battery when needed and/or on an annual schedule.

The smoke alarm installed in the motorhome is listed for use in recreation vehicles and complies with the latest industry standards to reduce cooking nuisance alarms and provides early warning in the event of a fire emergency.

Smoke alarms only work as intended if they are maintained in operational condition. Smoke alarms have a limited life and over time, will cease to function. Immediately replace the smoke alarm if it is not working properly, if it displays any type of problem, or as passed its expiration date. Be sure to read, understand, and follow the information provided by the smoke alarm manufacturer, including information on the limited life of smoke alarms.



RV-approved smoke alarm

Be aware the smoke alarm cannot detect fires if smoke does not reach it. Anything preventing smoke from reaching the alarm may delay or prevent an alarm.

Though the alarm horn in this detector meets or exceeds current UL standards, it may not be heard for reasons that include (but not limited to): a closed or partially closed door, distracting noises from electronics, appliances, loud outside noises, etc.

**Operation:**

The smoke alarm is operational once the battery is correctly installed. It will not function if the battery is missing, disconnected, dead, the wrong type, or not installed correctly. It requires one standard 9-volt battery. Refer to the smoke alarm manufacturer's owner's manual for correct battery and installation information.

The LED light indicates that the battery is functioning properly. When particles of smoke from combustion is sensed, the smoke alarm sounds a loud alarm that continues until the air is cleared of smoke. The LED light also gives a visual indication of a sounding alarm.

When the battery becomes weak, the alarm will 'beep' about once a minute indicating a low battery. This warning should last for 30 days. To assure continued protection, replace the battery once the smoke alarm's low battery warning (beeping) is detected.

**Test:**

To test the smoke alarm, stand at arm's length from the smoke alarm, as the alarm horn is loud and may be harmful to hearing. Actuate the test button, which will activate the alarm. Pressing the test button will accurately test all functions. **NEVER** use an open flame to test the smoke alarm.

**Maintenance:**

Vacuum off any dust on the cover of the smoke alarm using a soft brush attachment. Test the smoke alarm after being vacuumed. **NEVER** use water, cleaners, or solvents to clean the smoke alarm as these materials may damage the alarm. Do not paint the smoke alarm. Refer to the manufacturer's owner's manual for detailed maintenance information.

**Replacement:**

Smoke alarms have a limited life and must be replaced following the smoke alarm manufacturer's instructions, and/or the expiration date listed on the device.

## Exhaust Fumes and Gases

** WARNING**

**Avoid inhaling exhaust gases as they contain carbon monoxide, which is a toxic gas that is colorless and odorless.**

**A parked motorhome with either the vehicle's engine or the generator running, presents a potential danger of toxic exhaust fumes entering the motorhome.**

** IMPORTANT! TO AVOID BREATHING EXHAUST GASES, FOLLOW THESE PRECAUTIONS:**

- **DO NOT run the engine in confined areas, such as an enclosed garage, any longer than needed to move the motorhome in or out of the area.**

- **The windows should be closed while driving or running the generator (if equipped) to avoid drawing dangerous exhaust gases into the motorhome.**
- **If it is suspected that exhaust fumes are entering the passenger compartment, have the cause determined and corrected as soon as possible.**
- **If driving under these circumstances is unavoidable, close all the windows and adjust the heating or cooling system to draw outside air into the motorhome (set the blower on high speed).**
- **Ensure the motorhome's ventilation system and the carbon monoxide alarm are properly maintained. Keep the ventilation inlet grill(s) clear of snow, leaves, or other obstructions.**
- **Ensure the motorhome's engine exhaust and the generator's exhaust systems are properly maintained and functional. Repair any damaged exhaust system components immediately.**

## Carbon Monoxide (CO)

** DANGER**

**DO NOT use gas cooking appliances for comfort heating. Can lead to carbon monoxide poisoning, which can cause death or severe injury.**

** WARNING**

**The following symptoms are related to carbon monoxide poisoning and should be discussed with all members of the household:**

- **Mild Exposure - Slight headache, nausea, vomiting, fatigue; often described as flu-like symptoms.**
- **Medium Exposure - Severe throbbing headaches, drowsiness, confusion, fast heart rate.**
- **Extreme Exposure - Unconsciousness, convulsions, cardio-respiratory failure, death.**

** WARNING****CARBON MONOXIDE OR SUFFOCATION DANGER EXISTS**

- **Storage areas of the motorhome are not intended for human or animal occupancy. Failure to follow these instructions could lead to death or severe injury.**
- **DO NOT allow children to enter or to play in or around the motorhome's storage areas.**
- **Storage areas are not heated or cooled. Do not store perishables or items in this cargo area that may be damaged by exposure to hot or cold temperatures.**

Carbon monoxide (CO) is a poisonous gas that is colorless, odorless, and tasteless. Many cases of reported carbon monoxide poisoning indicate, that while victims are aware they are not feeling well, they become so disoriented they are unable to save themselves by either exiting the vehicle or calling for assistance. Due to their physical size, young children and household pets may be the first to show symptoms of carbon monoxide poisoning.

The risk of carbon monoxide poisoning and/or suffocation exists in any confined space. **DO NOT** allow children or pets to play or become entrapped within the storage compartments of the motorhome.



**IMPORTANT! Know the symptoms of carbon monoxide poisoning. If you or your passengers experience symptoms of carbon monoxide poisoning, seek immediate medical attention:**

- Dizziness
- Vomiting
- Nausea
- Muscular twitching
- Intense headache
- Throbbing in the temples
- Weakness
- Sleepiness
- Inability to think coherently

## Propane Safety



### **DANGER**

#### **IF YOU SMELL PROPANE GAS**

1. Extinguish any open flames and all smoking materials.
2. Shut off the propane supply at the container valve(s) or propane supply connection.
3. **DO NOT** touch or operate electrical switches.
4. Open doors and other ventilating openings.
5. Leave the area until the odor clears.
6. Have the propane system checked and leakage source corrected before using again.

Ignition of flammable vapors could lead to a fire or explosion and result in death or severe injury.



### **DANGER**

**NEVER TRAVEL WITH, AND/OR STORE PROPANE (LP) CONTAINERS OR CYLINDERS INSIDE THE MOTORHOME.**

Propane cylinders are designed to vent whenever internal pressures reach a certain threshold. Therefore, the potential of a venting propane cylinder presents a gas leak hazard, which, if ignited, could lead to an **EXPLOSION, FIRE, DEATH, OR SEVERE INJURY.**



### **DANGER**

**All pilot lights, appliances, and igniters (see operating instructions) must be turned off before refueling of motor fuel tanks and/or propane containers.**

**Can cause ignition of flammable vapors, which can lead to a fire or explosion and result in death or severe injury.**



### **DANGER**

**DO NOT use gas cooking appliances for comfort heating. Can lead to carbon monoxide poisoning, which can cause death or severe injury.**



### **WARNING**

**DO NOT fill propane container(s) to more than 80 percent of capacity. A properly filled container contains approximately 80 percent of its volume as liquid propane.**

**Overfilling the propane container(s) can result in uncontrolled propane flow, which could lead to a fire or explosion and result in death or severe injury.**



### **WARNING**

**Gas cooking appliances need fresh air for safe operation.**

#### **BEFORE OPERATING:**

- Open vents or windows slightly or turn on exhaust fan prior to using cooking appliance.
- Gas flames consume oxygen, which should be replaced to ensure proper combustion.
- Improper use can result in death or severe injury.



### **WARNING**

**THIS PROPANE PIPING SYSTEM IS DESIGNED FOR USE WITH PROPANE ONLY:**

- **DO NOT** connect natural gas to this system.
- Securely cap inlet when not connected for use.
- After turning on propane, except after normal cylinder replacement, test propane piping and connections to appliances for leakage with soapy water or bubble solution.
- **DO NOT** use products that contain ammonia or chlorine to test for leaks. These substances may weaken piping components and cause gas leaks, leading to fire or explosion, which could result in death or severe injury.

Warning labels are affixed throughout the motorhome to provide required information on propane safety. Read and follow the instructions listed, and exercise proper precautions when using propane and propane appliances.

Additional warning labels are located in the cooking area as a reminder that an adequate supply of fresh air for combustion is needed. Unlike a residential home, the oxygen supply in an RV is limited due to its small size. Proper ventilation must be provided when using gas cooking appliances to help avoid the dangers of low oxygen levels and potential asphyxiation.

Become thoroughly familiar with the propane system and its safe operation. Refer to the Propane System section of this manual and always follow the safety and operational instructions provided by the manufacturers of the propane appliances and devices installed in the motorhome.

## Combination Carbon Monoxide/Propane Alarm

### WARNING

**The carbon monoxide/propane (CO/LP) combination alarm installed is intended for use in ordinary indoor locations of recreation vehicles.**

**Actuation of this alarm indicates the presence of carbon monoxide, which is a toxic gas that is colorless and odorless.**

**DO NOT disconnect the combination carbon monoxide/propane alarm from its power source.**

**Individuals with medical problems may consider using warning devices that provide audible and visual signals for carbon monoxide concentrations under 30 PPM.**

**This alarm will only indicate the presence of carbon monoxide gas at the sensor. Carbon monoxide gas may be present in other areas.**

### WARNING

**DO NOT SLEEP IN THE VEHICLE WITH THE MASTER BATTERY SWITCH DISCONNECTED, WHICH DISABLES THE CO/LP ALARM.**

The CO/LP combination detector operates on 12-volt house power; it does not contain an internal back-up battery. It will be disabled when auxiliary batteries are disconnected, or shore power is removed, or if the auxiliary battery voltage drops below the operating threshold voltage of the detector!

### WARNING

Test the combination carbon monoxide/propane alarm after the motorhome has been in storage, before each trip, and at least once per week during motorhome use.

**FAILURE TO DO SO CAN RESULT IN AN UNDETECTED FAULTY CO/LP ALARM, WHICH COULD LEAD TO DEATH OR SEVERE INJURY.**

This motorhome is equipped with a combination carbon monoxide/propane alarm that is listed for use in recreation vehicles. The combination carbon monoxide/propane alarm will only provide its intended protection if it is maintained in operational condition.

The combination carbon monoxide/propane alarm is wired directly to the motorhome's 12-volt DC electrical system, with continuous power being supplied by the auxiliary battery. There is not a back-up battery in the combination carbon monoxide/propane alarm. If the auxiliary battery cable is disconnected at the battery terminals, the combination carbon monoxide/propane alarm will not be powered, and therefore, will not function.

This alarm is designed to detect the toxic carbon monoxide gas that results from incomplete combustion, such as those emitted from appliances, furnaces, fireplaces, and auto exhaust, along with propane gas that may be present. A carbon monoxide/propane alarm is NOT A SUBSTITUTE for other combustible gas, fire, or smoke detection alarms.

Although this alarm is designed to sense the presence of carbon monoxide/propane gas, there are other combustible fumes or vapors that may be detected by the sensor including, but not limited to: acetone, alcohol, butane, and gasoline.

Please note that there are hazards against which carbon monoxide detection may not be effective, such as detection of natural gas and other harmful substances.

These chemicals can be found in commonly used items such as deodorants, colognes, perfumes, adhesives, lacquer, kerosene, glues, wine, liquor, most cleaning agents, and the propellants of aerosol cans. Be sure to read, understand, and follow the owner's information from the manufacturer of the combination carbon monoxide/propane alarm. This includes information regarding the limited service-life of the alarm.



### **IMPORTANT! KNOW WHAT TO DO IF THE CO/LP ALARM SOUNDS:**

1. **Operate the RESET/SILENCE button.**
2. **Call emergency services (911 in the United States or a local fire department).**
3. **Immediately move to fresh air (outdoors, or by an open door or window).**
4. **DO NOT re-enter the motorhome or move away from the open door or window until the emergency service responders have arrived, the motorhome has been aired out, and the alarm remains in its normal (OFF) condition.**
5. **If the alarm reactivates within a 24-hour period, repeat steps 1-4, and call a qualified appliance technician to investigate for sources of carbon monoxide and inspect**

**for proper operation of this equipment. Make sure that motorized vehicle(s) and equipment are not and have not been operating adjacent to the motorhome.**

6. **Correct all identified problems immediately. Note equipment not inspected by the technician and consult the manufacturer's instructions or contact the manufacturer directly for more information about carbon monoxide safety and this alarm.**

#### Test:

The Test switch is located on the front of the alarm. Pressing the switch should activate the alarm horn. If the alarm fails to sound, refer to the Owner's Packet for information provided by the manufacturer of the combination carbon monoxide/propane alarm.

#### Maintenance:

Vacuum the alarm cover at least once a year. Clean the cover by hand using a cloth dampened in clean water. Dry with a soft cloth. Do not spray the front panel of the alarm with cleaning agents or waxes. Doing so could damage the sensor causing an alarm or cause the alarm to malfunction. Do not paint the face of the alarm.

#### Replacement:

The combination carbon monoxide/propane alarm has a limited service-life and must be replaced following the alarm manufacturer's instructions and/or the expiration date listed on the device.



Typical combination carbon monoxide/propane alarm

## Fuel System Safety

### **⚠ DANGER**

Potentially explosive fuel vapor may be present at fuel filling stations and during refueling of equipment with the fuel transfer system.

**NEVER** enter a fuel filling station or refuel equipment if your furnace or water heater is operating or if your refrigerator is operating on propane. Both the flame and the igniters in the burners of these appliances are sources of ignition and could cause an explosion.

**These appliances must be turned OFF before entering a fuel filling station or refueling equipment. Turning OFF the propane main tank valve only is not sufficient. The appliances must be OFF at their electrical operating switches.**

### **⚠ DANGER**

#### **NO SMOKING**

**Before dispensing fuel into fuel tanks and propane tanks, turn OFF all engines, fuel-burning appliances, and their igniters (see operating instructions).**

**DO NOT** dispense fuel within 20 feet (6.1 meters) of an ignition source.

**Can cause ignition of flammable vapors, which can lead to a fire or explosion and result in death or severe injury.**

### **⚠ WARNING**

Flammable solvents and clean-up materials should be temporarily stored in a nonflammable, vapor-tight container until proper disposal facilities are available. **DO NOT** store flammable clean up rags or materials inside the motorhome, inside any other vehicle or near any source of flame or ignition.

### **NOTICE**

Depending upon model and chassis, TMC Class A and Class C Motorhomes may be equipped with either gasoline or diesel-fueled engines. **Always be sure to fuel your motorhome with the correct petroleum products.**

Be extremely careful when fueling the motorhome. Always shut OFF the engine, **DO NOT** smoke, **DO NOT** use cellular phones, and shut OFF all pilot lights before adding fuel. Fuel spills represent a serious fire hazard and should be cleaned up immediately. **NEVER** restart the engine or relight pilot lights while fuel vapor is present.

In cold weather conditions or when the motorhome has not been used for a while, a fuel additive (customer supplied) may be needed. Refer to the chassis manufacturers recommendations for fuel additives.

## Location of Fuel Inlet

Due to design and construction considerations of this motorhome, the fuel inlet may be located on the left-side, right-side, rear, or select models may feature fuel inlets on both the left and right side of the motorhome.

The fuel gauge on this motorhome may include a symbol that points either to the left or right, indicating the side of the vehicle where the fuel inlet is located. This symbol was placed by the chassis manufacturer and may not represent the actual location of the fuel inlet of the motorhome.



Become familiar with the position of the fuel inlet of your motorhome regardless of the fuel inlet symbol. Doing so will help you approach the fuel pumps from the correct side, positioning the fuel inlet nearest to the fuel pumps.

## Fuel Cap

If the fuel cap is misplaced or lost, replace it as soon as possible with a cap of the same size and type. Fuel systems are pressurized, so a tight-fitting fuel cap is necessary. Always remove the fuel cap slowly and pay close attention to the fuel recommendations by the chassis manufacturer.



Typical fuel filling port.

## Freightliner Exhaust Emissions Systems

Diesel-powered Freightliner chassis' are equipped with an exhaust emissions reduction system, known as Selective Catalytic Reduction, or SCR. This system adds a Diesel Exhaust Fluid (DEF) into the exhaust gas and filters it through a catalyst to convert NOx into nitrogen and water, which is then released to the atmosphere. This system complies with current EPA emissions standards.

DEF is used at a 2-3% ratio to diesel fuel. So, on average, every 100 gallons of diesel fuel will require 3 gallons of DEF. A DEF tank is usually installed in a driver's-side bay. A low diesel exhaust fluid

(DEF) dash warning indicator illuminates when the DEF tank is approximately 10% full. Fill the DEF tank as soon as possible to avoid engine derate (decreased engine power).

Another important component of the diesel emissions control system is the Diesel Particulate Filter (DPF). This device requires routine maintenance and regeneration. A solid-illuminated dash lamp indicates a regeneration cycle is required. Change to a more challenging duty cycle, such as highway driving, to raise exhaust temperatures for at least 20 minutes, or perform a stationary regeneration. A blinking lamp indicates that a stationary regeneration is required immediately. An engine derate and shutdown will occur.

Along with emission system warnings, the Freightliner driver's dash cluster includes many other important operating indicators and warnings. Drivers and operators must become familiar with these and other unique operational procedures of diesel-powered vehicles.

Refer to your Freightliner Owner's and Maintenance Manuals or review information available through your Freightliner 24/7 App for detailed information regarding the emission systems installed in your Freightliner chassis.

*NOTE: DEF can be purchased in 2-3 gallon containers or most truck stops will offer DEF from a pump. DEF has a shelf-life. If purchased and carried in containers, be sure to pay attention to expiration dates, usually printed on the container.*



Typical DEF tank.

## Chemical Sensitivity

### WARNING

**Operating, servicing, and maintaining a passenger vehicle or off-road vehicle can expose you to chemicals including engine exhaust, carbon monoxide, phthalates, and lead, which are known to the State of California to cause cancer and birth defects or other reproductive harm.**

**To minimize exposure, avoid breathing exhaust, DO NOT idle the engine except as necessary, service your vehicle in a well-ventilated area and wear gloves or wash your hands frequently when servicing your vehicle.**

**For more information go to:**

[www.P65Warnings.ca.gov/passenger-vehicle](http://www.P65Warnings.ca.gov/passenger-vehicle)

When a new motorhome, and for some time afterward, has been closed-up for an extended time-period, strong odors associated with chemical off-gassing (or out-gassing) may be detected. This is not a defect of the motorhome. There are many materials and products used in the construction of recreational vehicles, such as carpet, linoleum, plywood, insulation, paint, and upholstery, which when new or when exposed to elevated temperatures and/or humidity, may off-gas chemicals, including formaldehyde. Off-gassing may cause irritation of the eyes, nose, and throat and sometimes headache, nausea, and a variety of asthma-like symptoms. Elderly people and young children, as well as anyone with a history of asthma, allergies, or lung problems, may be more susceptible to the effects of off-gassing.

*NOTE: Chemical off-gassing is not a defect in your motorhome and is not covered by the Thor Motor Coach Limited Warranty or the Thor Motor Coach Structural and Lamination Limited Warranty.*

### Formaldehyde

Most of the attention regarding chemical off-gassing surrounds formaldehyde. Formaldehyde is a naturally occurring substance and is also a key industrial chemical used in the manufacture of the numerous materials and products used in the construction of recreational vehicles. Trace levels of formaldehyde are also released from smoking, cooking, use of soaps and detergents, such as carpet shampoos, cosmetics, and many other household items. Some people are very sensitive to formaldehyde, while others may not experience a reaction to the same level of chemical exposure. The amount of off-gassed formaldehyde from the materials used in the construction of this motorhome will decrease over time.

California 93120 Phase 2 Formaldehyde Compliance:

This motorhome may be compliant to California Formaldehyde Phase 2 codes. If so, it will be labeled with a compliance identification tag similar to the illustration below. If you have questions or concerns regarding formaldehyde and your motorhome, please contact Thor Motor Coach Customer Care:

877-855-2867

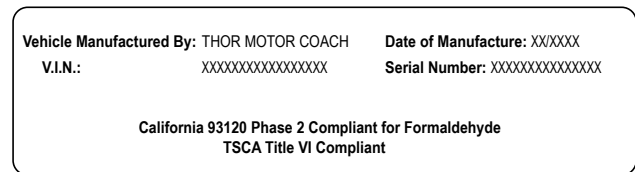

Typical California Formaldehyde Compliance label.

### Smoking and Medical Advice

TMC recommends no one smoke inside the motorhome. While potentially causing damage to the motorhome, tobacco smoke also releases formaldehyde and other toxic chemicals into the atmosphere; a condition heightened by the relatively small enclosed space of a motorhome.

If you have any questions regarding chemical sensitivity, consult with your physician or local health services provider.

### Ventilation

To reduce exposure to chemicals from off-gassing, it is of utmost importance to ventilate the motorhome. Chemical off-gassing is accelerated by heat and humidity; therefore, ventilation should occur frequently after purchase and at times when the temperatures and humidity are elevated. Keeping the motorhome tightly closed has the potential of increasing the formaldehyde level of the interior atmosphere. Ventilate the motorhome by opening windows, exhaust vents, and doors. Operating ceiling fans and vents, air conditioners, and the furnace will help dry the air and exchange the interior air with fresh outdoor air. Also, follow the recommendations regarding how to avoid condensation problems contained in Section 14.

*NOTE: For additional information about ventilation and chemical sensitivity, refer to TMC's Care and Maintenance System Guide, available through your on-line Owners Resource account.*

## Emergency Egress Window

Meeting regulatory standards at the time of manufacturer, your TMC motorhome is equipped with at least one emergency egress (exit) window. The emergency egress window is designed to allow for a quick evacuation of the motorhome if the main entry door is blocked or becomes unusable.

As a responsible motorhome owner, become familiar with the operation of all emergency egress windows installed in the motorhome. Be sure the latches and hinges remain in excellent working condition. Open emergency egress windows frequently and inspect window seals so that the window can be opened easily if an unexpected situation requires a rapid evacuating the motorhome.

Emergency egress windows come in a variety of styles, yet all are identified with a red operating handle, along with an EXIT label. An egress window may be designed as a quickly removable windowpane or section of a larger window unit or an entire window assembly. It is vitally important to know how to quickly operate the egress window(s) and evacuate the motorhome before an emergency occurs.

1. Before traveling in the motorhome, review the locations and instruct all occupants on how to operate the egress window(s).
2. When pulling into a campsite, make sure the ground below each egress window is solid and there is a clear escape path directly outside the egress window(s). Potential escape routes should be clear of trees, rocks, or other obstacles.
3. Plan and practice emergency escape procedures:
  - a. Decide who will exit through the egress window(s) first, and in what order.
  - b. The last person designated to exit the motorhome should be prepared to assist everyone exiting through the window.
  - c. Exit the motorhome as quickly as possible.
  - d. Designate a meeting place safely away from the motorhome.



Typical emergency egress window exit label

## Emergency Egress Procedure

In an emergency, it is extremely important to react quickly and efficiently. Have an exit plan formulated before it is needed and practice emergency exiting procedures so that everyone will be prepared to evacuate the motorhome rapidly and as safely as possible.



**IMPORTANT! To avoid head and neck injuries, climb through an emergency exit window feet-first.**

1. **Open emergency exit window by raising or sliding the red handle or latch and push the windowpane outward (see window latch section).**
2. **Position your body so that either your left or right hip is adjacent to the window opening.**
3. **Place your hands on the bottom of the window opening, gripping the opening with your fingers toward the inside. If your left hip is adjacent to the window, then your left hand will be forward of your right. If your right hip is adjacent to the window, then position your right hand forward of your left.**
4. **Swing the leg that is adjacent to the window up and out of the window. Your body will be astride the window opening. Steady yourself with your hands and arms (Figure 1).**
5. **Lower your upper body towards the bottom of the window while tucking your inside leg up towards the window opening.**
6. **Swing your lower body and inside leg out the window, ensuring your tucked inside leg and foot clears the window opening (Figure 2).**
7. **With a firm grip on the bottom of the window opening, lower your body while straightening your arms (Figure 3).**
8. **Release your grip on the window opening and drop to the ground.**
9. **If able, assist others exiting the motorhome and move everyone a safe distance away from the motorhome.**

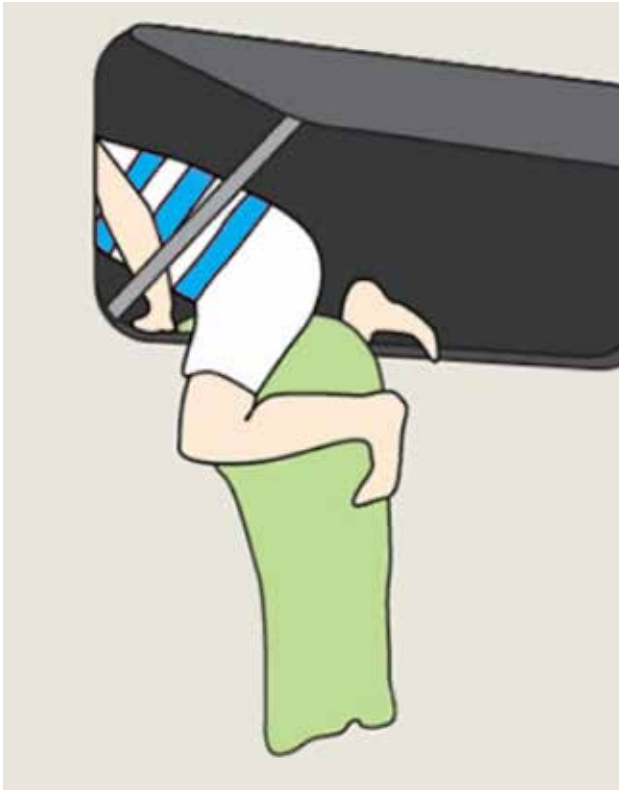

Figure 1

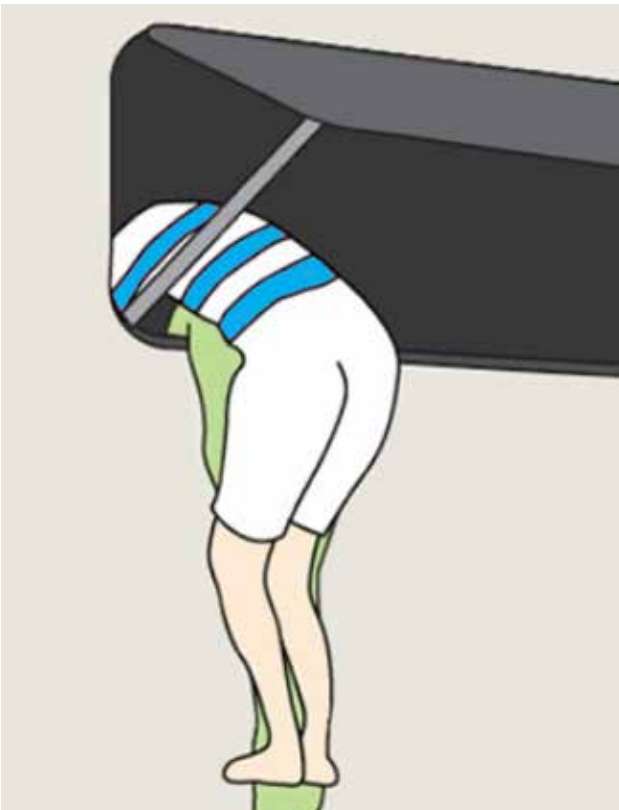

Figure 2

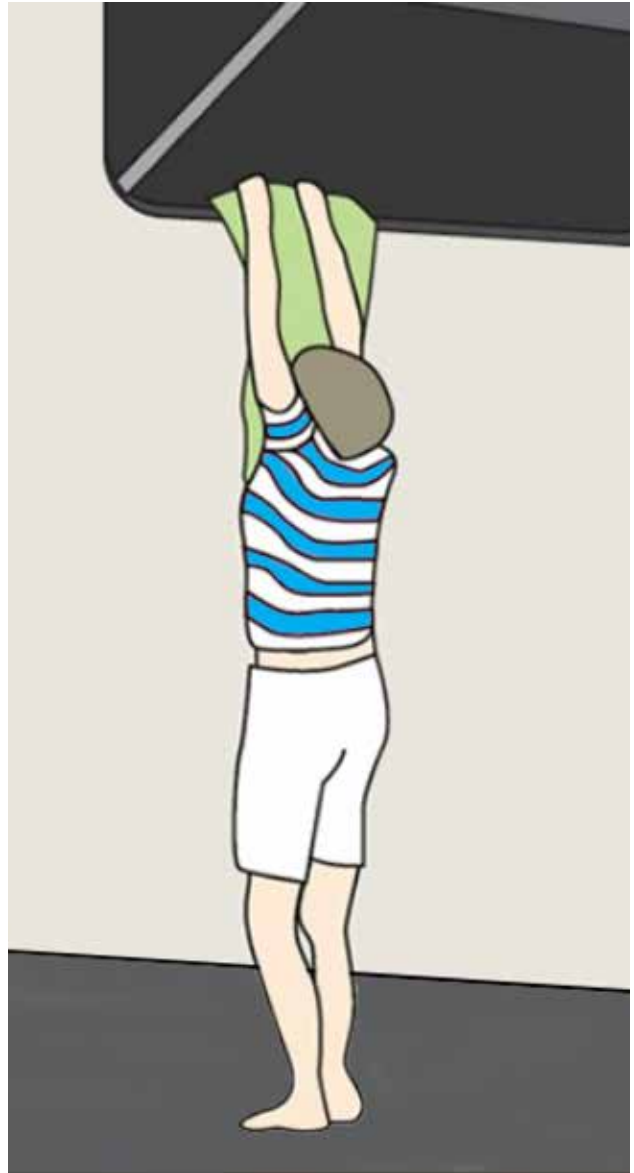

Figure 3

### Swing Latch Operation:

1. Remove window screens or other window obstructions and set aside, well out of the way of the egress window. Screens are removed by rotating the red tab located in the bottom corners of the screen frame.



2. Push the red handle towards the window frame and lift it to release from the latch. Egress window latches vary in style, but all will be clearly marked with an 'Exit' label and be red in color.



3. Rotate the handle until it is perpendicular to the window frame.



4. Push the handle, which opens the window. If the window pane is stuck, pushing on the window pane's frame may be necessary in order to free it from the window seal. Continue to push the handle until it is completely clear of the slot in the window frame.



### Lever Latch Operation

Egress windows may have a latch style similar to the illustration below. Larger windows may have two similarly styled latches.

To operate:

1. Locate red window latch.
2. Lift and rotate latch to unlock window.
3. With latch completely in the upright position, push window open.



Additional egress window information:

- When an egress window does not have a screen, it is only intended for use as an egress window and is not intended to be used for ventilation purposes. However, some models may be equipped with a window screen. For safety reasons, **DO NOT** add a window screen to an egress window if one did not come factory installed.
- Emergency egress windowpanes may be designed to break-away when opened beyond a certain angle. Unless an emergency exists, **DO NOT** open the egress window more than a 45-degree angle; the pane may dislodge from the frame.
- To avoid window damage, the egress window must be closed tight and locked when the motorhome is traveling.
- Release latch mechanisms will vary depending on the egress window design. The egress window may be hinged at the top or side, be designed to breakaway, or feature sliding windowpane(s).
- Open egress windows at least twice a year and lubricate the seals to keep the seals pliable and prevent sticking.

## Rear Cargo Door

### **⚠ WARNING**

**THIS IS NOT AN ENTRY DOOR.**

This door should only be used for loading and unloading items from storage area.

Use of this door as an entry door can lead to death or severe injury.

### **⚠ WARNING**

**THE TRANSPORTATION AND STORAGE OF FUEL-POWERED EQUIPMENT OR VEHICLES INSIDE THE MOTORHOME IS PROHIBITED. FAILURE TO ADHERE TO THIS PROHIBITION CAN LEAD TO INJURY OR DEATH.**

### **⚠ WARNING**

Failure to properly stow, secure and prevent movement of cargo can result in injury or death.

Exceeding the vehicle's Occupancy Cargo Carrying Capacity can lead to vehicle instability which can result in occupant injury or death.

Select TMC motorhomes are equipped with a rear cargo door. The purpose of this door is to provide loading and unloading access to a sleeping space that converts to a large cargo storage and transportation area. This cargo access door is not designed or intended to be a passenger entry door; however, it can be used as an EMERGENCY EXIT.

Since this area is not sealed from the passenger compartment, it is not designed to accept fuel-powered equipment or transportation devices. **DO NOT** transport fuel or fuel containers inside the motorhome, due to the risk of explosion or inhalation of fuel vapors.



Typical rear cargo door. For this particular floor plan, the photo illustrates rear bed in a stowed (up) position.

## Front Airbags

### **⚠ WARNING**

Your motorhome may be equipped with an airbag restraint system. Follow all airbag instructions provided by the chassis manufacturer, including all warnings regarding the placement and safety of child and infant passengers.

Failure to do so can result in death or severe injury.

If the vehicle is equipped with front passenger airbags, ensure that the airbag system is appropriately set for the size and weight of the front passenger. Refer to the chassis manufacturer's owner's manual for front airbag operation.

## Seatbelts

### **⚠ WARNING**

- All occupants in this vehicle must be seated at a designated seating position and must wear seatbelts at all times while this vehicle is in motion.
- All swivel and/or reclining seats must be returned to their upright, forward-facing, and locked position while the vehicle is in motion.
- Seatbelts are designed for single occupancy. **DO NOT** use a seat belt for more than one person at a time.
- The sleeping accommodations in this vehicle are designed for occupancy only while vehicle is **NOT** in motion. **DO NOT** occupy beds or any other seats that are not equipped with seatbelts while the motorhome is in motion.
- Seatbelts installed in areas that convert to beds or bunks may fall between cushions or framework. Be sure beds are in their upright seating position and all seatbelts are properly and securely placed and available for use before travel.

Failure to do so can result in death or severe injury.

### **⚠ WARNING**

Failure to inspect and if necessary, replace damaged seatbelts could result in severe personal injuries in the event of a collision.

If seat belt replacement is necessary, ensure mounting and fastening devices are torqued to manufacturer's specifications.

All occupants must be seated and furnished with and use seatbelts while the motorhome is in motion. Additionally, the sleeping accommodations in the motorhome are to be used **ONLY** while the vehicle is parked. **NEVER** allow passengers to lie down while the motorhome is in motion. They would not be properly

restrained in the event of a traffic accident or sudden vehicular movement, such as swerving to avoid a road hazard.

#### Operation:

Driver and front passenger seats must be locked in a forward-facing position with seatbelts fastened while the motorhome is in motion. Avoid seat rotation while in transit.

- Insert the belt tongue into the proper buckle (the buckle closest to the direction the tongue is coming from) until hearing a click and feeling the buckle latch. Make sure the tongue is securely fastened in the buckle.
- Adjust the belt to the proper position; snug and as low as possible around the hips; not around the waist.
- To unfasten, push the release button and remove the tongue from the buckle.

#### Inspection and replacement:

Periodically inspect motorhome's seatbelts to make sure they work properly and are not damaged; make sure there are no nicks, tears, or cuts in the belt material. Replace the motorhome seatbelts as necessary. A qualified service technician should inspect all seat belt assemblies after a collision. TMC recommends that all seat belt assemblies used in vehicles involved in a collision be replaced.



Typical seat belt located in dinette seating area

## Child Safety Restraint System

### **⚠ DANGER**

- **NEVER** allow a passenger to hold a child on his or her lap while the motorhome is in motion. **United States and Canadian traffic laws require the use of safety restraints for children while the vehicle is in motion.**
- **If small children, generally children who are four years old or younger and weigh 40 lbs. (18 kg. or less), ride in the motorhome, they must be put in properly installed safety seats made especially for children.**
- **Rear-facing child seats or infant carriers should NEVER be installed and used in the front seats of the motorhome.**

**Failure to use child restraint systems correctly can result in serious injury or even death.**

### **⚠ WARNING**

- **Improper installation or failure to properly secure a child restraint can lead to failure of the restraint. The child could be severely injured or killed.**
- **Follow the child restraint manufacturer's directions exactly when installing an infant or child restraint.**
- **NEVER** place a child safety restraint in front of an airbag. **A deploying passenger front airbag can cause death or severe injury to a child 12 years or younger, including a child in a rear-facing child restraint.**
- **NEVER** install a child safety restraint in the front seat of a vehicle. **Only use child safety restraints in the rear seats. If the vehicle does not have a rear seat that includes a safety restraint belt or anchor that enables securing a child safety seat, DO NOT transport children requiring child safety restraints in that vehicle.**
- **To ensure proper safety belt fit, always use booster seats for children who are size and age appropriate. Refer to the vehicle manufacturer's safety information or governmental safety regulations for child sizing charts.**
- **Always follow the vehicle manufacturer's safety instructions, along with state and federal regulations regarding transporting children and small adults.**



Child Safety Seat Anchor and lap belts. Strictly follow the installation directions of the child safety seat manufacturer when securing any child safety device to the motorhome.

When transporting a child that requires the use of a child safety restraint system (seat), TMC recommends installing the child safety seat in the forward-facing booth dinette position. If the motorhome is not equipped with a forward-facing booth dinette seat equipped with seatbelts and a child safety seat anchor, small children that require a child safety seat should not be transported in the motorhome. For rear-facing child seats and infant carriers, the dinette table can be placed in the DOWN position to allow adequate room for the rear-facing child seat.



**IMPORTANT! Follow the instructions and warnings that are included with any infant or child safety restraint system:**

- **If the child is the proper size, restrain the child in a safety seat. Children who are too large for child safety seats or booster seats, as specified by the safety seat manufacturer, should use standard seatbelts.**
- **If the shoulder belt portion of a combination lap and shoulder belt can be positioned so it does not cross or rest in front of the child's face or neck, the child should wear the lap and shoulder belt.**
- **NEVER use pillows, books, or other objects to boost a child, passenger, or pet.**

*NOTE: Check with your local and state or provincial laws for specific requirements regarding the safe transport of children in your motorhome.*

For additional information, refer to:

<https://www.nhtsa.gov/parents-and-caregivers>

or call: 1-888-327-4236.

In Canada, refer to Transport Canada's website:

<https://tc.canada.ca/en/road-transportation/child-car-seat-safety>

## Transporting Pets



### WARNING

**Unsecured and unrestrained animals can interfere with safe vehicle operation and may be thrown around in the vehicle in the event of an accident or sudden steering and braking maneuvers, injuring vehicle occupants and pets in the process.**

- **NEVER leave animals in the vehicle unattended.**
- **Always secure animals while the vehicle is in motion, using a suitable and secured animal harness or carrier.**

Airbags deploying in the front seat could harm pets. An unrestrained pet will be thrown about and possibly become injured or injure a passenger during panic braking or in a collision.

Pets should be restrained in the rear seat (if equipped) in pet harnesses or pet carriers that are secured by seatbelts or other anchoring devices.

Refer to the chassis manufacturer's owner's manual for additional and important information regarding occupant and pet safety.

## Driver and Front Passenger Seats



### WARNING

**All swivel seats located in the cab of the vehicle (driver and front passenger) must be in the locked, upright and forward-facing position while the vehicle is in motion and seats are occupied.**

**Driver, front passenger, and all occupants must always wear seatbelts while the vehicle is in motion.**

**Failure to do so can result in death or severe injury.**

For comfort and convenience, the motorhome may be equipped with tilt and swivel seats in the cockpit area. These features are designed to only be used when the motorhome is parked. Before travel or moving the motorhome, ensure all front seat backs are returned to an up-right position, swiveled, and locked in their forward-facing position.

Select TMC motorhomes include tilt and swivel seating in the coach area (sometimes referred to as barrel chairs). Any adjustable seat that is equipped with seatbelts and intended for passenger occupation while the vehicle is in motion, must be returned to an up-right and swivel-locked position before travel.

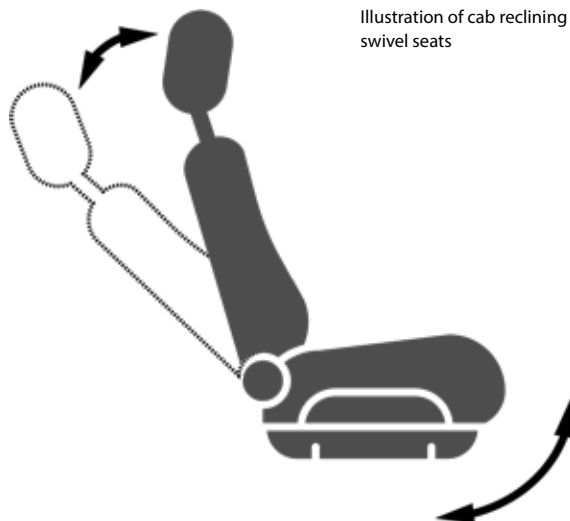

Illustration of cab reclining and swivel seats

## Mirrors and Vision Systems

For safe driving and maneuvering, both on and off the highway, it is imperative that the motorhome driver/operator becomes proficient with using mirrors and vision systems. Vision aids for motorhomes vary, due in part to the variety of motorhome classes and sizes. Optional equipment and driver preferences are also factors that determine the type of vision aids equipped on motorhomes.

### Mirrors

The rear-view mirrors on the motorhome should always be kept in adjustment and good working order. Although some mirrors have motorized adjustments, most mirrors also have provisions for manual adjustments.



Mirrors are a vital component of safe motorhome operation. Convex mirror and side-view camera illustrated below.



#### Mirror features:

The rear-view mirrors installed on the motorhome may include some or all these features:

- **Side View Camera:** If the rear-view mirrors are equipped with side-view cameras, the left-side or right-side camera will automatically turn on with the application of the left or right turn signals. View the camera in the dash monitor (radio screen) to help aid with maneuvering the motorhome around the turn. When the turn signals cancel, the dash monitor will revert to the previous screen.
- **Blind Spot Detection:** The motorhome mirrors may be equipped with Blind Spot Detection (BSD) indicators. If so, a symbol in the mirror surface will appear whenever a vehicle or object is along the side of the motorhome, out of the normal view of the mirrors. The indicator will turn off when the vehicle or object has moved out of the blind-spot zone.
- **Heated Mirrors:** The rear-view mirrors may have built-in heating elements that will keep the mirrors free of ice and snow. A switch located on the dash controls mirror heaters.
- **Wide-View:** The convex portion of the mirror allows for a good side view of the motorhome and is used to detect cars or obstacles along the side of the motorhome. Note that convex mirrors affect visual perspective.

#### Mirror adjustments:

It is usually best to enlist the help of someone stationed outside the motorhome to aid with mirror positioning.

1. Locate the adjustment screws on the mirror head and arm and obtain the correct size wrench or screwdriver for the adjustment screws.
2. Loosen the adjustment screws to where the mirror will move with slight force, but not so loose that the mirror will not hold position.
3. Sit in the driver's seat and adjust the seat for your normal driving position.
4. Look out the side windows at both the left and right mirrors and ask your helper to adjust the mirrors so that you can slightly see the side of the motorhome, while maintaining a good rearward view without needing to move your upper body.
5. Tighten the setscrews and check the mirrors again to ensure the mirrors held their position.

*NOTE: Adjusting rear-view mirrors may require re-calibration of Blind Spot Detection cameras.*

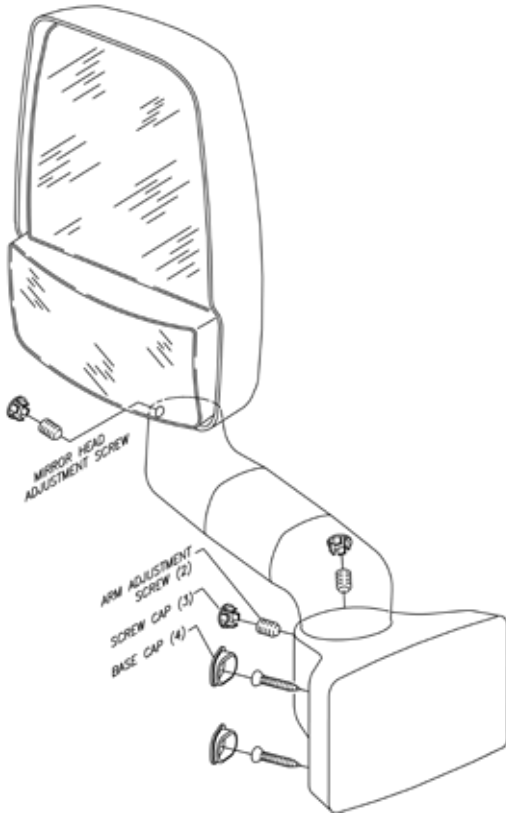

Typical mirror adjustments

### Vision Systems

TMC motorhomes may be equipped with a rear and/or side vision system. If equipped, the installation includes a rear-view camera mounted along the top of the motorhome’s rear valance and an in-dash camera monitor (usually the dash radio screen). Some installations will also include side-view cameras. Camera signals are fed to the dash radio/camera monitor and appear when the gear selector is placed in reverse, or for side-view cameras, actuated by the turn signals. Some Class C installations include a camera monitor in the cab rear-view mirror.

*NOTE: Select touchscreen dash multimedia radios are equipped with a no-tools-required adjustable mount, providing up/down, swing, and rotating motions, making viewing and operating screen functions convenient for both driver and front passenger.*

To operate:

1. For the camera monitor to function, the dash radio must be on. It is powered by the auxiliary battery(ies), therefore, the Master battery switch must also be ON. It is normal to keep the Master battery switch in the on position while traveling. Doing so also allows the vehicle’s charging system to charge the auxiliary battery(ies) while the engine is running.
2. When the gear selector is placed in REVERSE, the radio display automatically changes to the rear-view camera monitor, allowing for a rearward view via the camera and monitor system.
3. When the gear selector is moved out of REVERSE, the camera will automatically turn off and the radio display will revert to the previous screen.



Typical dash radio with camera monitor



Typical rear vision camera located along the top rear edge of the motorhome.

## Blind Spot Detection, Class A

### **⚠ CAUTION**

**DO NOT** rely on the Blind Spot Detection (BSD) solely. The system is not intended to be a replacement for safe and diligent driving. It is a supplement to the standard vehicle mirrors and should not be relied on to guarantee that a vehicle is not located in a blind spot.

### **NOTICE**

- The following are Blind Spot Detection system limitations:
- The system's detection zone includes the one adjacent lane on either side of the vehicle from the mirror back to 10 feet behind the rear bumper.
- The system may have reduced accuracy when the vehicle equipped with the system is traveling less than 20 mph. Drivers should not rely upon the system when traveling below 20 mph.
- The system may not provide adequate warning for vehicles approaching at a large speed differential relative to the speed of your vehicle.
- The system does not adjust its detection zone when a trailer or vehicle is being towed.
- Movement of the mirror heads may cause the system to become out of calibration and therefore unable to accurately detect vehicles. If the mirror heads are moved, you must recalibrate immediately to ensure proper operation of the system. See the recalibration section of the manufacturer's owner's manual included in your TMC Owner's packet or from TMC's on-line Owner's Resource service.
- The system does not detect narrow vehicles such as motorcycles or bicycles, people, pets, or other roadside features.
- The system may not function properly in inclement weather conditions such as fog, heavy rain, or snow.
- The system will not reliably operate when the camera lens is obstructed.
- The system has reduced accuracy when backing up. Drivers should not rely upon the system when backing up.
- The system may detect vehicles following your vehicle on sharp curves or roundabouts, resulting in false positives.

Beginning with model year 2024, select TMC Class A motor homes are equipped with a Blind Spot Detection system. The Class A system is based on smart camera technology, using computer vision and the images from cameras mounted in the left and right-side mirrors to detect objects in the blind spots of the motorhome. The vision detection software installed has been

developed to understand what probably is a motorized vehicle. If the system detects a motor vehicle in the blind spot on one or both sides, a detection icon illuminates in the respective mirror flat glass, warning the driver that a vehicle is in the motorhome's blind spot.

*NOTE: You must register your system within 30 days of the purchase of your motorhome to receive the benefits of the limited warranty for the system. Failure to properly register will void the limited warranty, unless such warranty registration requirement is prohibited by applicable law.*

*Follow the registration steps included in the manufacturer's owner's manual for this Blind Spot Detection system. Contact your dealer or TMC's Customer Care for registration assistance.*

#### System Hardware:

- A. "VDS" Video Data Server: Provides computer vision to process video from cameras mounted in the left and right mirrors.

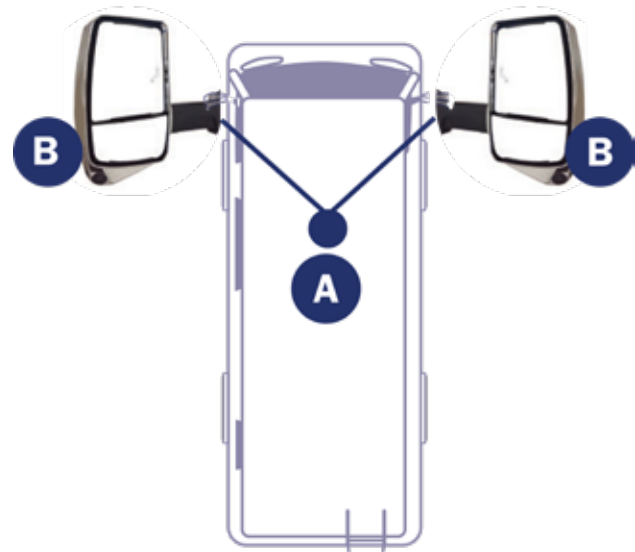

- B. Mirrors with Cameras: Left and right mirrors have built-in cameras and in-glass indicator icons.

#### Powering ON the BSD System:



1. Turn ON the vehicle's ignition.



- LED Lights in the mirrors will turn ON for 5 seconds then OFF for 45 seconds, then back ON for 5 seconds.

*NOTE: Ensure camera lenses are free of dirt and obstructions.*

*Ensure that the mirror head is positioned properly (See recalibration section in the manufacturer's owner's manual).*

Detection Zones:

The system detects vehicles in the blind spot zone which consists of one adjacent lane on either side of the vehicle and from the mirror back to 10 feet behind the rear bumper.



The Blind Spot Detection System is programmed to detect Department of Transportation (DOT) approved motor vehicles: motorcycles, cars, and trucks. It will not detect pedestrians, bicycles, and animals.

*NOTE: Always use the interior and exterior mirrors and when possible, look over your shoulder when changing lanes. To help avoid injuries, NEVER use Blind Spot Detection as a replacement for using the interior and exterior mirrors or looking over your shoulder before changing lanes. BDS is not a replacement for careful driving.*

Driver Alerts:

The BSD system will indicate the presence of vehicles in the side blind spots via the mirror icons. When a vehicle is in a side blind spot zone, the mirror icon will light. If a turn signal is ON and a vehicle is in a side blind spot zone, the icon will flash ON and OFF. Certain conditions can trigger false alerts and Blind Spot Detection is not meant as a replacement for normal safe driving practices.

Situations that trigger blind spot detection:

- No vehicle in blind spots, turn signals OFF:**

Mirror icons OFF.

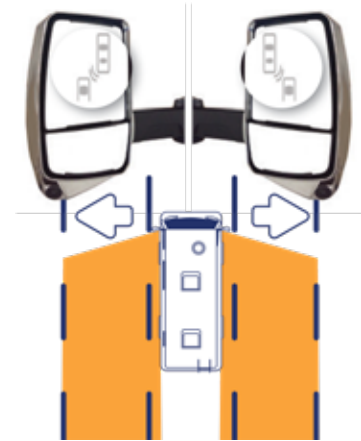

- Vehicle in blind spot, turn signal is OFF:**

Icon in the corresponding mirror illuminates.

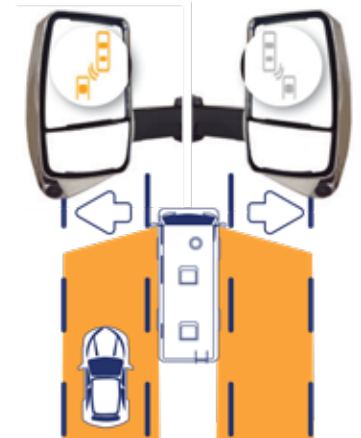

- Vehicle in blind spot, turn signal is ON:**

Icon flashes ON and OFF in the corresponding mirror.



### System Fault Alerts:

Certain conditions may make the blind spot detection system unable to operate properly (such as weather-related issues and mirror mis-adjustments). However, the system does contain alerts that may indicate either a temporary system fault or a system fault that requires servicing.

#### If the mirror icons are continuously flashing:

- There is a problem with the system that may require servicing. Try cleaning the camera lenses or re-adjusting the mirrors following the recalibration process.
- Or, system validation application setup process was not completed.
- Or, the camera(s) is damaged or disconnected.



#### If the mirror icons are continuously illuminated:

- The system is not functioning.
- Or, there is a loss of power
- Or, there is a blown fuse, disconnected or damaged wire, or hardware failure.



#### If the mirror icons never illuminate:

- Test by turning ON the vehicle's ignition and watch for the mirror icons to flash or temporarily turn ON.
- There may be a blown fuse, damaged or disconnected wiring harness.

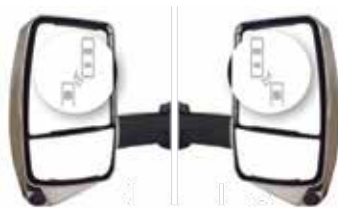

### System Information Tags:

A manila (tan) tag is provided with the motorhome that contains important QR codes and related system information.

#### IMPORTANT: RETAIN THIS TAG FOR REFERENCE!

These codes are used to recalibrate mirror position or are accessed by a service technician if system service is required.

- A. **Wi-Fi QR Code:** Scan with your phone or tablet or manually enter the Wi-Fi SSID and password printed on the label.
- B. **System Validation QR Code:** This QR code is for validating BSD system functionality and will be needed if the BSD system needs servicing. *This code should only be accessed by trained service technicians.*
- C. **System and Vehicle Information:** Contains vehicle and system configuration information.
- D. **Customer Part Number Identification.**

#### Front of Tag



#### Back of Tag

These QR codes and part number labels are also attached to the back of your manufacturer's User Guide, included in your TMC Owner's Packet.



## VEHICLE SAFETY

## System Recalibration Process:

The mirrors come from the factory already calibrated and aligned to the correct position. For the BSD system to work properly, the mirrors need to stay in the calibrated position. If the mirrors are moved or re-adjusted, they will need to be recalibrated. Follow the steps below to recalibrate the BSD system.

*NOTE: Any shift in position of the mirrors may result in reduced accuracy of the BSD system. If the mirrors have a fixed, non-adjustable head, contact support for help:*

[www.road-iq.com](http://www.road-iq.com)

## Step 1:

- A. Turn ON the motorhome's engine, ensuring the transmission remains in PARK (or neutral for diesel pushers) and the PARKING BRAKE is engaged.

- B. Connect your smart phone to the VDS Wi-Fi Network.

Using the QR code reader on your phone or tablet, scan the Wi-Fi code located on the manila tag or on the back of your User's Guide.

Go to the Settings App and select Wi-Fi and look to see if a blue check mark is appearing next to the Road-iQ network, indicating you are connected. It can take up to 1 minute to connect.

## Step 2:

- A. Connect to Calibration Tool.

Using the QR code reader on your phone or tablet, scan the Calibration QR code located on the manila tag or back of your User's Guide.

- B. Once you are connected, you will see a screen appear that gives a view of either the left or right mirror camera.

## Step 3:

Tap on 'View Instructions' and follow the steps.

- A. Select the desired camera (left or right side) using the bottom two buttons.

- B. Loosen the set screw on the mirror and adjust mirror head until the back edge of the vehicle appears in the green shaded area. Repeat for each side.

Tap on 'Close Instructions' to give a larger camera view on your phone's screen.

- C. Tighten the set screws to secure the mirror head position.

Tap on the question mark (?) in the upper right corner to contact support.

For additional information, go to: [www.road-iq.com/helper](http://www.road-iq.com/helper)

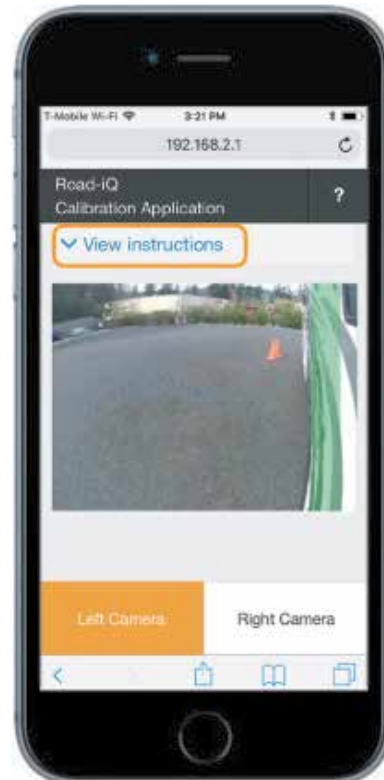

Left and right-side camera calibration views.



Illustrations and information courtesy of Velvac, Inc.

## Blind Spot Detection, Class C

### ⚠ CAUTION

Due to technical limitations in ultrasonic sensor systems, the motorhome driver should **NEVER** solely rely on Blind Spot Detection (BSD) for vehicle avoidance assistance. This BSD is designed as a supportive driver's aid and not a replacement for the proper use of rear-view mirrors and other visual means of safe lane changing or other safe driving practices.

### NOTICE

The following conditions affect the BSD system's effectiveness:

- Natural or foreign substances on the sensor surfaces (snow, rain, mud, etc.).
- Paint, tape, graphics, or other materials placed on the surface of the sensors.
- Sensors under the influence of high electromagnetic forces.
- Too narrow or too wide of adjacent traffic lanes.
- Heavy snow or rain weather conditions.
- The road surface or sub-surface contains an unusual amount of metallic substances.
- Too high temperatures of the sensor or surface area surrounding the sensors.
- Low objects that are out of the sensor's range (curbs, debris in the road, etc.).
- Narrow roads in densely forested areas.
- Driving status out of the BSD system's operational parameters.



Blind Spot LED Indicator mounted on vehicle's left and right side 'A' pillars.

Select TMC Class C motorhomes are equipped with an ultrasonic blind spot detection system. Sensors located along the left and right side of the motorhome detect objects that occupy areas just to the rearward side of the motorhome, but out of the visual area covered by the left and right-side rear-view mirrors.

For maximum effectiveness, the Blind Spot Detection System utilizes short-range and long-range ultrasonic sensors to detect vehicles in the highway lanes adjacent to the motorhome. The illustration on the following page indicates the approximate coverage area of the system.

#### Blind Spot Indicator:

1. When a vehicle enters the blind spot detection area, LED Warning Indicators, mounted on the inside left and right 'A' pillars of the motorhome light up, indicating the presence of an approaching or passing object in the blind spot zone. The Blind Spot Indicator extinguishes when the object is no longer in the blind spot zone.

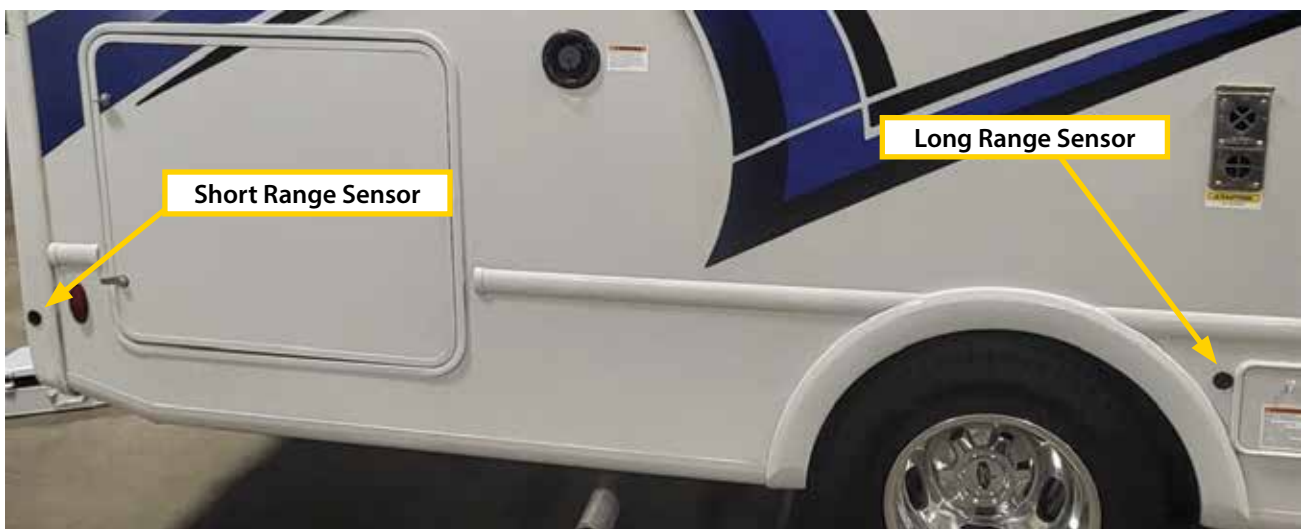

Typical Sensor location on the side of a Class C motorhome.

2. The Blind Spot Indicator flashes with either a left or right turn signal activation AND an object is in the corresponding blind spot zone.
3. The system is only operational when the vehicle's ignition is ON.

*NOTE: In addition to the LED indicators, the Blind Spot Detection system may also include an audible signal, which emits a tone when an object is present in the vehicle's blind spot. If the installed system includes this feature, the audible signal can be turned ON or OFF by a switch located on the underside of the dash, near the steering column.*

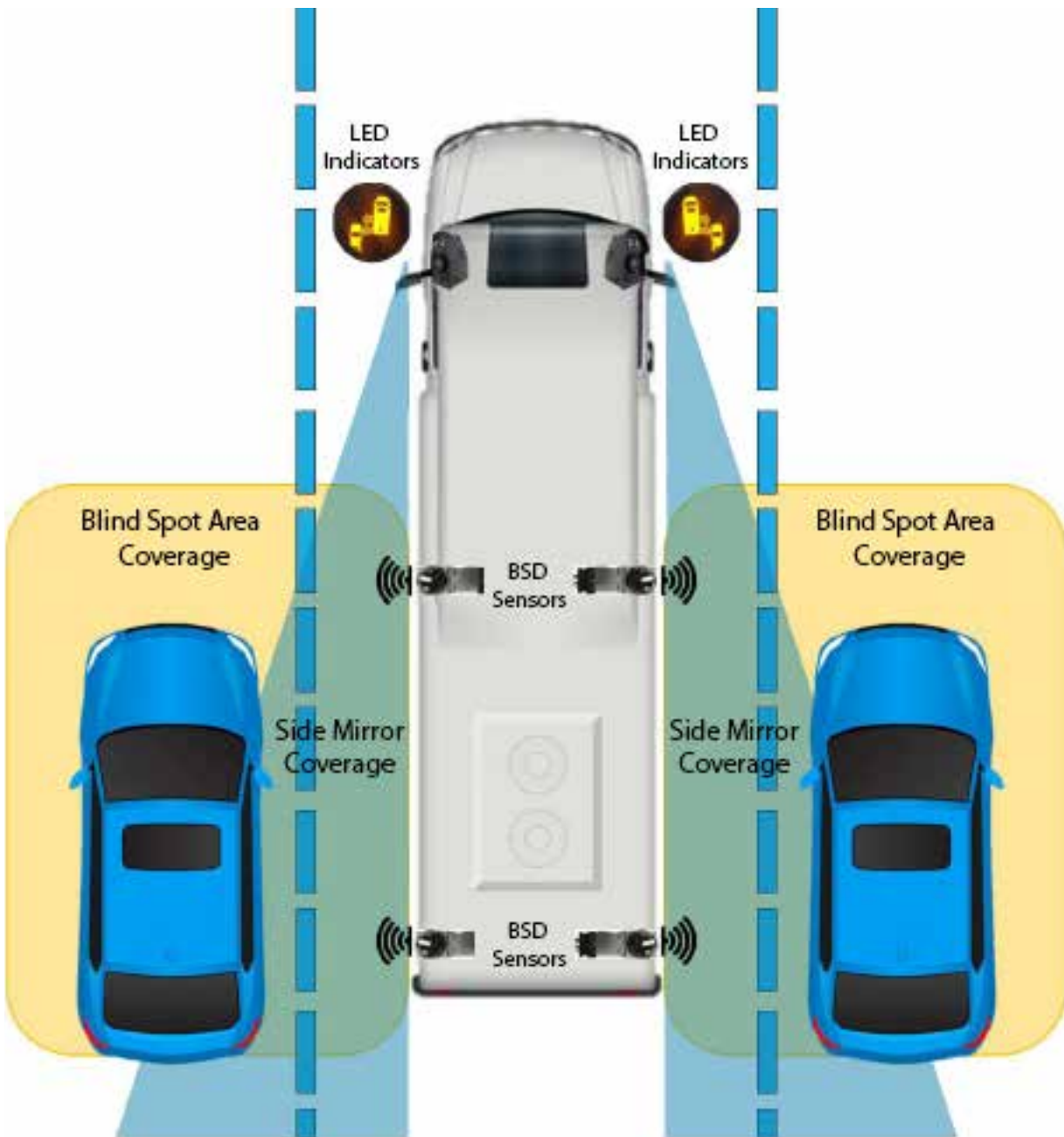

Illustrations and information courtesy of Dual Electronics Corporation.

## Safely Driving the Motorhome



**IMPORTANT! Always follow safe driving practices while operating this vehicle.**

- All occupants must wear safety belts.
  - a. Passengers can dramatically reduce their risk of being killed or seriously injured in a crash by wearing safety belts.
  - b. Drivers should be responsible for ensuring all passengers are properly using safety belts.
  - c. **NEVER** transport more passengers than there are available safety belts installed in the motorhome.
  - d. Ensure infants and children are properly secured in age-and-weight appropriate safety restraints.
  - e. Secure pets in harnesses or other appropriate safety restraints.
- Motorhomes are substantially longer, wider, and heavier than cars, they:
  - a. Require more space and additional reliance on the side-view mirrors for changing lanes, turning corners, and making parking maneuvers;
  - b. Require additional braking time and distance;
  - c. DO NOT respond as quickly to abrupt steering inputs;
  - d. Are affected by strong winds, which in some conditions, can make driving the motorhome difficult;
  - e. Have a higher center-of-gravity, which affects the vehicle's handling characteristics.
- Always operate the motorhome at a safe speed, which in some conditions may be less than the posted speed limit.
- Drivers must be well-rested, alert and maintain a safe speed for weather and road conditions.
- Drivers should keep their eyes on the road and hands on the steering wheel.
- Drivers should not allow themselves to become distracted while operating the motorhome. If something other than operating the vehicle requires driver attention, safely pull off to the side of the road and attend to the situation.
- Drivers must be especially cautious on curved roads and maintain a safe speed to avoid running off the road or losing control of the motorhome.
- If the vehicle's wheels proceed off the roadway, gradually reduce speed and steer back onto the roadway when it is safe to do so. Avoid abrupt maneuvers to return the vehicle to the roadway.
- The vehicle may be equipped with advanced driver assist technologies. Remember that even advanced technology cannot overcome the laws of physics. It's always possible to lose control of a vehicle due to inappropriate driver input for the conditions.
- In the event of a flat tire or tread separation, gradually slow down the vehicle, steer to the side of the road while avoiding abrupt maneuvers.
- Ensure all drivers and co-drivers are practiced with the unique driving and handling characteristics of the motorhome.
- Backing the motorhome can present unique challenges and hazards. Use mirrors, back-up cameras and when necessary, a spotter (person outside the motorhome) to ensure safe vehicle movement.
- Always carry up-to-date and correct paperwork such as valid vehicle registration and proof of insurance, valid driver's license, etc.
- DO NOT exceed the vehicle weight limits or axle weight limits specified on the Federal Weight Label (see Section 6). Exceeding vehicle weight ratings could result in severe damage to the vehicle, loss of vehicle control, and increases the risk of vehicle rollover and personal injury.
- Towing trailers beyond the maximum recommended gross towing capacity of this vehicle and its towing hitch could result in a loss of vehicle control, vehicle damage, rollover, and personal injury. Refer to Section 6 of this manual and the chassis manufacturer's owner's manual for important towing information.

*NOTE: Depending on the weight and length of the motorhome, states or provinces may require a Commercial Driver's License, or CDL, to legally operate (drive) the motorhome. Before traveling, check local and regional vehicle operational requirements. Then, check with your Bureau of Motor Vehicles to ensure you have the proper endorsements on your driver's license.*

## Emergency Parking



**IMPORTANT! IF AN EMERGENCY REQUIRES STOPPING AND PARKING ALONG THE HIGHWAY, FOLLOW THESE SAFETY GUIDELINES:**

1. **Pull off the road as far as possible.**
2. **Put the motorhome's transmission in the PARK position (neutral for diesel pushers) and apply the PARKING BRAKE.**
3. **Turn ON the hazard warning flashers.**
4. **Use three red warning indicators such as flares, reflectors, or lanterns as required by the Uniform Vehicle Code and Model Traffic Ordinance as follows:**
  - a. **Place the first warning indicator on the traffic side of the motorhome, directed toward traffic approaching the rear of the motorhome, approximately 10 feet from the rear bumper.**
  - b. **Place the second warning indicator 100 feet behind the motorhome, in the center of the lane or shoulder occupied by the motorhome, and directed toward traffic approaching the rear of the motorhome.**
  - c. **Place the third warning indicator 100 feet in front of the motorhome, in the center of the lane or shoulder occupied by the motorhome, and directed towards the traffic approaching the front of the motorhome.**
  - d. **If stopped within 500 feet of a curve, crest of a hill, or other obstruction to view, place a warning indicator in the direction of the obstruction (front and/or back of the motorhome), at a distance of 100 feet to 500 feet from the stopped motorhome so as to afford ample warning to traffic approaching the motorhome.**
5. **Always stand off the road, out and away from of the lanes of traffic.**

### NOTES:

- *Curves and/or hills may affect the safe placement of warning indicators, such as safety reflectors, cones, flares, etc. Extinguish flares before leaving the emergency parking site.*
- *Along with other emergency equipment (reflectors, first-aid kit, etc.), it is good safety practice to carry a reflective safety vest and wear it anytime you are outside of your motorhome while stopped or parked along a road or highway.*

Reference: Emergency signals, stopped commercial motor vehicles; Code of Federal Regulations: Title 49, Subtitle B, Chapter III, Sub-chapter B, Part 392, Subpart C, 392.22.

## Laws of the Road

It is advisable to contact the Department of Motor Vehicles in each respective state for up-to-date information regarding operation and licensing requirements for the motorhome and its drivers/operators.

The State of California requires operators of motorhomes over 40 feet in length to obtain a non-commercial class B license. California has also enacted legislation limiting use of motorhomes in excess of 40 feet, to approved roadways. Other states or provinces may have driver/operator restrictions and/or regulations pertaining to motorhome operation.

Contact Caltrans at:

<https://dot.ca.gov/contact-us>

## Chassis Manufacturer's Vehicle Safety Features

The manufacturer of the vehicular portion of this TMC Class A or Class C motorhome (Ford, Chevrolet, Mercedes-Benz, Freightliner) may have incorporated safety and driver-assist features into the vehicle.

Varying with brand and model, safety features may include; Adaptive Cruise Control, Attention Assist, Traffic Sign Assist, Active Lane keeping Assist, Blind Spot Assist, Forward Collision Warning with Active Braking, and more.

Review the vehicle manufacturer's owner's manual and other sources of information from the manufacturer to fully utilize the safety and driver-assist features of this new Class A or Class C motorhome.

*This page is intentionally blank*

## Tire Safety

### DANGER

Failure to follow proper inflation guidelines may result in tire failure, which under certain circumstances, can cause loss of vehicle control or accidents that may result in property damage, bodily injury, and/or death.

### WARNING

Check tire pressure at the beginning of each trip and frequently throughout the trip to obtain the maximum performance and life from the tires. Follow the instructions listed on the Federal Certification label, located inside your motorhome, to determine the correct tire pressures.

### IMPORTANT! READ AND FOLLOW THE SAFETY INSTRUCTIONS LISTED BELOW BEFORE TRAVELING IN YOUR MOTORHOME:

- Proper care and maintenance of the motorhome's tires is essential to the safe operation of this motorhome.
- Following the tire inflation guidelines, located on the Federal Weight Label, is mandatory to achieve maximum load capacity (see Section 5).
- Under-inflation of tires is just as dangerous as over-inflation.
- To ensure the motorhome tires are operating at their peak performance and safety, regular tire inspection and checking of tire pressures is mandatory.
- Wheel alignment, wheel balance, tire inflation, improper loading, and worn bearings will affect tire wear. Examine the motorhome's tires frequently and inspect for cracking, bulging, uneven tread wear, and other tire-related issues.



Always be attentive to the condition of your motorhome's tires.

- When traveling in your motorhome, check the inflation pressure of each tire at least weekly to insure maximum tire performance, and travel wear. Tire pressure should only be checked when the tires are cold. When the motorhome is underway, tires heat up and the air pressure inside the tire increases.

NOTE: NHTSA's tire rating listings are located on-line at:

<https://www.nhtsa.gov/vehicle-safety/tires>

## Tire Inflation and Inspection

Tires and wheels support the entire weight of this motorhome and its contents. The tires are also the only contact the motorhome has with the road surface. Determining and maintaining proper tire inflation and weight (load) restrictions are the most important factors in maximizing the life of motorhome tires.

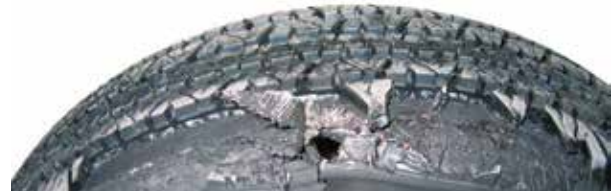

Tire pressure under and/or over inflation can cause severe tire failure.

Driving on a tire that does not have the correct inflation pressure for the vehicle load is dangerous and may cause premature wear, tire damage, tread separation and/or loss of control of the motorhome. Avoid premature tire damage by keeping tires properly inflated.

Find your PSI:

PSI (pounds force per square inch) is a measure of air pressure used to correctly inflate the tires. The correct PSI listing for both front and rear tires is located on the motorhome's Federal Weight Label (see Section 6). KPa (kilopascals) is another commonly used air pressure measurement:

1 PSI=6.894 kPa

## Checking Tire Pressures

Check all tire pressures (including the spare tire) before and after a trip and at least weekly while traveling, using an accurate pressure gauge. Always check inflation pressures when the tires are cold. Correct tire inflation cannot be determined by visual inspection only.

The vehicle may include a Tire Pressure Monitoring System (TPMS), but this is NOT a substitute for manually checking tire pressure. See the chassis manufacturer’s owner’s manual for additional information.

**Tire Inflation Tips:**

Always check tire inflation pressures before and after trips, and at least once a month while storing the motorhome.

- Remember to allow the motorhome's tires cool before taking a tire pressure reading.
- Have all luggage, equipment, fluids (fuel, water, gas, etc.) and accessories in the motorhome before weighing to determine the total gross vehicle weight.
- **NEVER** exceed the vehicle load capacity found on the Occupant and Cargo Carrying Capacity Label or the maximum load molded on the tire sidewall.
- Make sure to check the inflation pressure of outer and inner tires to ensure even load distribution.
- Adjust the inflation pressure on all tires to match the tire that is carrying the heaviest load.
- All tires on the same axle should have the same inflation pressure to support the heaviest load.

## Inspect the Condition of Your Tires







It’s important to check every tire on the motorhome on a regular basis. Rotate the tires completely and make sure there are no nails or other objects penetrating any of the tires. If a tire fault is found, do not drive the motorhome until the tires are inspected by an authorized commercial tire dealer. Immediately replace any tires if necessary.

**Tire Inspection Tips:**

- Check every tire for signs of sidewall cracking.
- Avoid using sidewall treatments or dressings, which can actually accelerate cracking.
- Look for worn tires that can decrease traction, reduce handling and are more susceptible to punctures.
- Replace tires before they reach the tread depth indicator.
- Tread depth indicators are located between the tread grooves at locations marked on the sidewall with little triangles.

Reference: Goodyear Tire and Rubber Company: Publication 00-00-46437-11/14

## Common Tire Wear Patterns

IF YOUR FRONT TIRES LOOK LIKE THIS:						
TIRE PATTERN	TOE	CAMBER	CENTER	EDGE	CUPPING	PATCHY
COMMON CAUSE	VEHICLE WHEEL ALIGNMENT	VEHICLE WHEEL ALIGNMENT	TIRE OVER INFLATION	TIRE UNDER INFLATION	VEHICLE WORN SUSPENSION	TIRE OUT OF BALANCE

*NOTE: The use of tire traction devices (snow chains) may either be prohibited or required in certain travel regions and/or weather conditions.*

*Always check with the state's Department of Transportation for vehicle operating guidelines and regulations.*

## Lug Nut Torque

### CAUTION

As part of your pre-travel checklist, always check lug nut torque with a properly calibrated torque wrench. Torque lug nuts to the vehicle manufacturer's specifications.

Always properly torque lug nuts as part of a tire changing procedure.

Ensuring wheel mounting nuts (lug nuts) on the wheels are tight and properly torqued is a vitally important responsibility for safe motorhome travel. Inadequate and/or inappropriate wheel nut torque (tightness) is a major reason that lug nuts loosen or fail in service. Loose lug nuts can rapidly lead to a wheel separation with potentially serious safety consequences.

Refer to the chassis manufacturer's information for proper lug-nut torque and tightening sequence.

## Wheel Alignment

### **NOTICE**

The front suspension and steering system of this motorhome was factory aligned prior to it being dispatched to the dealership. The alignment is however, greatly affected by the way the unit is loaded prior to travel. This loading includes how much cargo, water, and LP are carried as well as the distribution of said cargo.

Thor Motor Coach advises to have the alignment checked in the fully loaded condition (the way you would normally load the unit to travel). Not having the alignment checked and reset can result in abnormal tire wear.

It is very important to maintain proper wheel alignment for the motorhome. Improper wheel alignment not only contributes to premature tire wear, but also severely affects vehicle handling. Keeping the motorhome's front wheels in alignment is part of a normal maintenance routine. Please follow the recommendations listed in the notice above and on the corresponding label affixed to this motorhome.

Toe-in and toe-out (only) are inspected by TMC prior to shipment to your selling dealer.

## Changing a Damaged Tire

### WARNING

The motorhome is a very heavy vehicle. Raising the motorhome to replace the spare tire should only be done with extreme caution by a qualified technician and with the proper tools. The vehicle could slip, causing death or severe injury.

**DO NOT ATTEMPT TO DO THIS YOURSELF. ALWAYS CALL FOR ROADSIDE ASSISTANCE TO JACK YOUR MOTORHOME AND TO CHANGE DAMAGED TIRES.**

**DO NOT use the leveling jack system to support the motorhome while under the vehicle or changing tires. The leveling system is not designed to support the entire weight of the motorhome.**

**DO NOT use the leveling jack system as a jack or in conjunction with a jack.**

If a tire change is required, it is highly recommended the work be performed by a knowledgeable and trained professional.

Attempts to change a tire while supporting the motorhome with the leveling jack system could result in damage to the motorhome and risk causing death or severe injury.



**IMPORTANT! IF YOU EXPERIENCE A FLAT TIRE WHILE DRIVING YOUR MOTORHOME:**

- Gradually decrease your vehicle speed, braking lightly if possible.
- Hold the steering wheel firmly and direct the motorhome to a safe place along the side of the road.
- Once safely parked, place warning markers as described in Section 3, Emergency Stopping.
- Contact a road service provider, a qualified RV service repair center, or call 911 (in the U.S.) for assistance.
- To avoid personal injury, do not attempt to change a spare tire or jack the motorhome yourself. This is why a jack handle has not been included with your motorhome.
- Make sure the road service technician is familiar with proper tire changing procedures, ensuring that wheel lug nuts have been tightened to the torque specified by the chassis manufacturer.

## Tire Identification Information

To maintain the load capacity of this motorhome, it is vitally important to replace worn or damaged tires with tires with ratings equal to or higher than what was originally equipped on this vehicle. The illustration below describes important tire information that is embossed on every tire by the manufacturer.

The Load Index may be indicated with two numbers separated with a forward slash. The first number is the load index of the tire configured as a single tire on a single wheel. The second number indicates the load index of the tire as a dual-wheel configuration. Multiplying the second number by 2 will give the total Load Index for a dual wheel configuration.

*NOTE: The load index per tire configured as dual wheel is less than a single tire to provide a margin of safety for the load-carrying capacity of the tire in the event that one of the dual tires is punctured or otherwise fails.*

*NOTE: The illustration below describes important tire information that is embossed on every tire by the manufacturer. NHTSA's tire rating listings are located on-line at:*

<https://www.nhtsa.gov/equipment/tires>

**P or LT:** The "P" indicates the tire is for passenger vehicles. "LT" indicates the tire is for light trucks.

**MAXIMUM PERMISSIBLE INFLATION PRESSURE:** This number is the greatest amount of air pressure that should ever be put in the tire. This is NOT the same as the vehicle manufacturer's recommended tire pressure.

**MAXIMUM LOAD RATING:** This number indicates the maximum load the tire can carry.

**TEMPERATURE RATING:** The temperature rating indicates how well the tire resists heat. The grades are A, B, and C. Temperature A tires are designed to run cooler at higher speeds than B or C tires, but the rating does not necessarily mean that B and C rated tires are inferior to A rated tires.

**ASPECT RATIO:** This two-digit number gives the tire's ratio of height-to-width. A number of 50 or lower indicates a short sidewall for improved steering response and better overall handling.

**TRACTION:** The traction rating indicates the tire's ability to allow a car to stop on wet pavement in a shorter distance. The grades are AA, A, B, and C, where an AA graded tire has the highest coefficient of friction, measured by a skidding tire on a wet surface.

**TREADWEAR:** The treadwear rating indicates how long the tire should last. The higher the number, the longer it should take for the tires to wear down.

**NOMINAL WIDTH:** This three-digit number gives the width of the tire in millimeters from sidewall edge to sidewall edge. The larger the number, the wider the tire.

**R:** The "R" stands for radial. Radial tires have been the industry standard for several decades.

**RIM DIAMETER CODE:** This two-digit number is the wheel or rim diameter in inches.

**LOAD INDEX:** This two or three-digit code indicates the maximum weight a tire can safely carry when properly inflated, and correlates to a specific weight in pounds or kilograms. Higher load index numbers mean the tire can support more weight.

**SPEED RATING:** The speed rating indicates the maximum speed a tire can safely operate while carrying its load for a sustained period of time. It is represented by a letter code from A to Z, with higher letters indicating higher speeds.

**M+S:** This code indicates that the tire has some mud and snow capability.

**MANUFACTURER:** This is the name of the tire's manufacturer.

**U.S. DOT TIRE IDENTIFICATION NUMBER:** This number begins with the letters 'DOT' and indicates that the tire meets all Federal Standards. The next two or three numbers or letters are the plant code where the tire was manufactured. The last four numbers represent the week and year the tire was produced. For example, the numbers 3120 mean the 31st week of the year 2020. The other numbers are marketing codes used at the manufacturer's discretion. This information is for contacting consumers if a tire defect requires a recall.

Illustration courtesy of NHTSA,

## Tire Replacement

### **⚠ WARNING**

**Failure to replace damaged tires with tires of the same size, type, traction, and load rating than the originally equipped tires can significantly affect the weight carrying capacity, handling, and safety of your motorhome.**

**Ensure the spare tire is the same size and specifications listed on your motorhomes Federal Weight Label. Tires degrade over time depending on conditions they are subjected to throughout their service life; such as weather, storage, and conditions of use (load, speed, inflation pressure, etc.).**

**In general, tires should be replaced after six years regardless of tread wear. Heat caused by hot climates or frequent high-loading conditions can accelerate the aging process and may make it necessary to replace tires more frequently. Due to aging, the spare tire should also be replaced when replacing the road tires, even if it has never been used.**

All tires should be replaced with the same size, type, load rating, traction, and temperature rating (or better) than the original equipped tires. Tire specifications are listed on the motorhome's Federal Weight Label (Section 6) or found within the chassis manufacturer's owner's manual.

The load index of tires configured as dual-wheels is less than the sum of the tires. This provides a margin of safety for load-carrying capacity in the event that one of the dual tires is punctured or otherwise fails.

#### NOTES:

- *The tires supplied on your Class C and some Class A motorhomes carry a "Light Truck" rating.*
- *Installing replacement tires with a higher limit than that of the originals does not increase the payload capacity of the motorhome. Refer to the chassis manufacturer's owner's manual for tire safety and replacement information.*

## SmoothTech™ Suspension

Select TMC motorhomes are equipped with SmoothTech suspension upgrades. This system adds rubber compression springs to the rear suspension, allowing for longer spring travel and reduced suspension harshness, which enhances cushioning and absorption of road-induced bumps and shocks.



Rubber compression springs give your SmoothTech equipped TMC motorhome improved ride comfort.

*NOTE: There are no user-controls, settings or adjustments for the SmoothTech suspension system. It is mentioned here for informational purposes only.*

Image courtesy of Morryde, Inc.

*This page is intentionally blank*

## Introduction

### **WARNING**

**DO NOT exceed any applicable motorhome weight ratings. Doing so could damage your motorhome or affect handling and braking characteristics.**

**Your motorhome's braking system is designed and rated for operation at the gross vehicle weight rating (GVWR) listed on the unit's weight labels, not the gross combined weight rating (GCWR).**

### **CAUTION**

**A supplementary braking system should be used for safe control of towed vehicles and for trailers weighing more than 1,500 pounds when loaded. Supplemental braking systems are required by transportation laws.**

Proper loading of the vehicle is one of the most important considerations when traveling in a motorhome. The motorhome is designed to carry a certain safe maximum load. This is the Gross Vehicle Weight Rating, or GVWR. When towing a trailer or vehicle, the added weight calculates towards the total weight of the motorhome (Gross Combined Weight, or GCW). Staying within the safe weight limits of the motorhome will help to it performs and operates safely for your journeys.

Both the chassis manufacturer and Thor Motor Coach provide weight ratings and recommendations for loading this motorhome. Read and follow the information provided by the chassis manufacturer in the chassis manufacturer's owner's manual as well as information provided by Thor Motor Coach in this owner's manual. Important weight ratings are listed on labels affixed to your motorhome. Do not remove these important safety labels.

 **IMPORTANT! NEVER LOAD THIS MOTORHOME OR TOW A TRAILER OR VEHICLE THAT IS BEYOND THE SAFE WEIGHT-CARRYING RATINGS AND TOWING CAPACITIES OF THE MOTORHOME AND INSTALLED TOWING HITCH.**

## Important Weight Terminology

Listed in this section are several important terms that you should become familiar with to safely load and use your motorhome as a towing vehicle. Also review the chassis manufacturer's owner's manual for important loading and towing information.

### Curb Weight:

The weight of an unloaded motorhome plus the weight of a full fuel tank. Does not include propane, water, passengers, cargo, or aftermarket add-ons.

### Unloaded Vehicle Weight (UVW):

The curb weight of the unloaded motorhome plus the weight of a full propane tank.

### Cargo Weight:

The total weight of all cargo added to the motorhome, including food, clothing, camping gear, pots and pans, tools, water (fresh and waste), propane, and all aftermarket equipment added to the motorhome. Also includes trailer tongue weight. Keep in mind, carrying unnecessary water quantities (fresh or waste) adds significantly to the total cargo weight:

- NOTE:*
- 1 gallon of water = 8.3 pounds*
  - 1 gallon of propane = 4.2 pounds*
  - 1 gallon of gasoline = 6 pounds*
  - 1 gallon of diesel fuel = 7 pounds*

### Occupant and Cargo Carrying Capacity (OCCC):

The maximum weight of all cargo and occupants that can be safely carried by the motorhome. The tongue weight of the towed trailer or vehicle must be included in the total cargo weight. **DO NOT EXCEED THE OCCC RATING OF THIS MOTORHOME.**

OCCC is determined by subtracting the UVW of the motorhome from the GVWR of the chassis, plus the weight of any carried LP fuel. The OCCC of this motorhome is listed on the yellow OCCC label, affixed to the forward, right-side entry or passenger door.

### Gross Vehicle Weight Rating (GVWR):

The maximum permissible weight of a fully loaded motorhome. GVWR is determined by the chassis manufacturer and takes into consideration the design of the frame, suspension components, axles, and tires. This rating can be found on the Incomplete Vehicle Identification Data Label affixed to the driver's door jamb.

### Gross Vehicle Weight (GVW):

The actual measured weight of a fully loaded vehicle. Gross Vehicle Weight = Curb Weight + Total Cargo Weight + Total Passenger Weight). **THE MEASURED GVW MUST NEVER EXCEED THE GVWR OF THE MOTORHOME.**

**Gross Combined Weight Rating (GCWR):**

The maximum allowable loaded weight of this motorhome, including the weight of its towed trailer or towed vehicle. This rating is determined by the chassis manufacturer and takes into consideration the design of the chassis, suspension components, tires, engine torque and horsepower, and drivetrain components.

**Gross Combined Weight (GCW):**

The actual measured combined weight of the loaded motorhome plus the weight of a loaded trailer or towed vehicle. This weight measurement is found by weighing the motorhome with its towed vehicle on a commercial vehicle scale. **THE MEASURED GCW MUST NEVER EXCEED THE GCWR OF THE MOTORHOME.**

**Gross Axle Weight Rating (GAWR):**

The value specified as the load carrying capacity of a single axle system, as measured at the tire ground interfaces. This rating is determined by the manufacturer of the chassis. This rating can be found on the Federal Weight Label, affixed to the driver's door jamb (Class C and B) or near the driver's seat (Class A).

**Gross Axle Weight (GAW):**

Gross axle weight is the total weight of the fully loaded motorhome on each axle. This weight figure is determined by weighing the fully loaded motorhome with a loaded trailer or towed vehicle. See your owner's manual for instructions on weighing your motorhome.

**Tongue Weight:**

Weight directly transferred to the hitch of the motorhome by a loaded trailer. The maximum tongue weight is listed on the motorhome's hitch label. **BE SURE THAT TONGUE WEIGHT NEVER EXCEEDS THE GAWR OF THE REAR AXLE OF THE MOTORHOME. DO NOT EXCEED THE TONGUE WEIGHT RATING OF THE HITCH.**

When loading a trailer, remember to place heavy cargo over the axle(s) of the trailer, however the trailer must have some tongue weight to help stabilize the trailer while being towed.

**Maximum Loaded Trailer Weight:**

The highest possible weight of a fully loaded trailer or towed vehicle the motorhome can tow based on a minimally loaded motorhome (GVW).

**Towing Capacity:**

Towing capacity is determined by subtracting the measured Gross Vehicle Weight (GVW) from the Gross Combined Weight Rating (GCWR). **DO NOT EXCEED THE TOWING CAPACITY RATING OF THE HITCH AND THE MOTORHOME.**

## Federal Weight Label (USA)

The Federal Weight Label is typically affixed to the driver's door jamb for Class B and C motorhomes and near the driver's seat for Class A motorhomes. This label concisely states the gross vehicle weight rating (GVWR) of the motorhome, along with the gross

axle weight rating (GAWR) (both front and rear), tire size, tire weight rating, and proper tire inflation. This information meets the requirements of 49 CFR part 571.120 as issued by the National Highway Traffic Safety Administration (NHTSA).

<b>MANUFACTURED BY:</b> THOR MOTOR COACH, INC.			<b>OFFLINE:</b> MM/YY		
<b>GVWR:</b> XXXX KG (XXXXX LB)			<b>SERIAL:</b> XXXXXXXXXXXXXXX		
<b>INC. VEH. MFG. BY:</b> <Insert Chassis Manufacturer>			<b>MODEL:</b> XXXX		
<b>GAWR KG(LB)</b>	<b>TIRES</b>	<b>RIMS</b>	<b>COLD INFLATION PRESSURE</b>	<b>SINGLE</b>	<b>DUAL</b>
<b>FRONT:</b> XXXX (XXXX)	XXXXX/XXXXX	XXXXXX	XXX KPA(XX PSI)	<input type="checkbox"/>	<input type="checkbox"/>
<b>REAR:</b> XXXX (XXXX)	XXXXX/XXXXX	XXXXXX	XXX KPA(XX PSI)	<input type="checkbox"/>	<input type="checkbox"/>
<b>TAG:</b>				<input type="checkbox"/>	<input type="checkbox"/>
<b>THIS VEHICLE CONFORMS TO ALL APPLICABLE U.S. FEDERAL MOTOR VEHICLE SAFETY STANDARDS IN EFFECT ON MM/DD/YYYY</b>					
<b>V.I.N.:</b> XXXXXXXXXXXXXXXXXX			<b>TYPE:</b> MOTORHOME		

Typical Federal Weight Label, including GVWR, GAWR, and tire pressure information

## Occupant and Cargo Carrying Capacity Weight Label (OCCC)

The Motorhome Occupant and Cargo Carrying Capacity (OCCC) weight label is affixed to the interior side of the forward-most passenger door of Class B and C motorhomes and on the interior surface of the entry door of Class A motorhomes. This label indicates how much additional weight that can be safely carried by the motorhome. The total weight of passengers, cargo, trailer tongue weight, and water (fresh and waste) should **NEVER** exceed the values shown on this label.

This label also includes important safety belt seating capacity information and the measured overall length of the motorhome.

### NOTES:

- If a boat, trailer, or other vehicle is being towed, it should be weighed and combined with the motorhome's weight to ensure the total weight of the motorhome and towed vehicle does not exceed the gross combined weight rating (GCWR) of the motorhome. Contact your dealer or the chassis manufacturer for GCWR ratings.
- Depending on the date of manufacturer, the OCCC label attached to your motorhome includes length specifications.

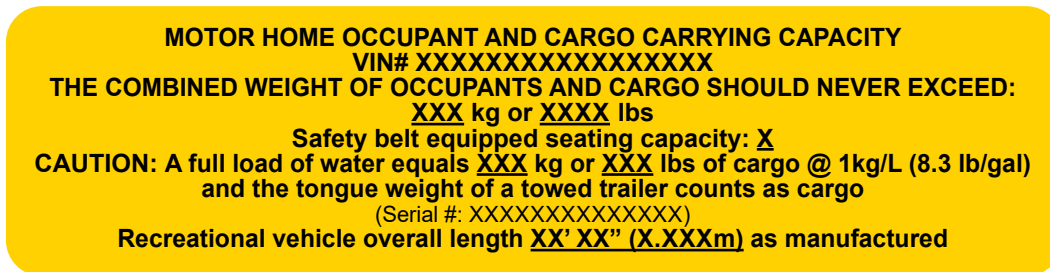

Typical Motorhome Occupant and Cargo Carrying Capacity Label

## Weight Capacity of Rear Garage Area

Motorhomes that include a rear garage area have a separate weight capacity rating for this cargo area. This weight capacity is listed on a label attached to the inside wall of the garage. The total weight of garage cargo must **NEVER** exceed the labeled capacity AND the weight of cargo carried in the garage must

be included in the total weight of occupants and cargo of the motorhome. The total weight of the occupants, garage cargo, water (fresh and waste), trailer tongue weight, and other supplies must NOT exceed the Occupant and Cargo Carrying Capacity (OCCC) of the motorhome.

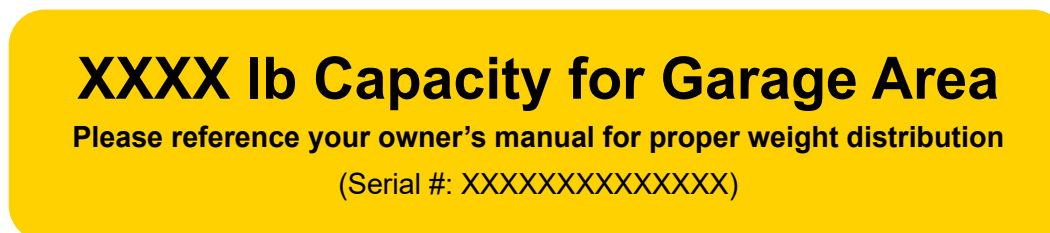

Typical Garage Area Weight Capacity Label

## Manufacturer Modified Label (USA)

A manufacturer-modified label is affixed to the driver's door frame of Class B and C motorhomes and to the driver's window of Class A motorhomes. This label indicates that, as a modified vehicle (modified by TMC from its original chassis manufacturer's specifications), the motorhome complies with all applicable

safety, bumper, and anti-theft standards, which vary depending on the manufacturing date.

**ALTERED BY:** THOR MOTOR COACH  
**V.I.N.:** XXXXXXXXXXXXXXXXX

**TYPE:** MULTIPURPOSE PASSENGER VEHICLE  
**Serial Number:** XXXXXXXXXXXXXXXXX

**THIS VEHICLE WAS ALTERED BY Thor Motor Coach, Inc. IN MM/YY AND AS ALTERED IT CONFORMS TO ALL APPLICABLE FEDERAL MOTOR VEHICLE SAFETY, BUMPER, AND THEFT PREVENTION STANDARDS AFFECTED BY THE ALTERNATION AND IN EFFECT IN MM/DD/YYYY.**

## Manufacturer Modified Label (Canada)

A dual-language manufacturer-modified label (English/French) is affixed to the driver's door frame of Class B and C motorhomes and to the driver's window of Class A motorhomes. This label indicates that, as a modified vehicle (modified by TMC from its original

chassis manufacturer's specifications), the motorhome complies with all applicable safety, bumper, and anti-theft standards, which vary depending on the manufacturing date.

**ALTERED BY / MODIFIÉ PAR:** THOR MOTOR COACH  
**V.I.N. / N.I.V.:** XXXXXXXXXXXXXXXXX **SERIAL NUMBER:** XXXXXXXXXXXXXXXXX  
**DESIGNATED SEATING CAPACITY / NOMBRE DESIGNÉ DE PLACES ASSIÈGES:** THOR MOTOR COACH  
**TYPE OF VEHICLE / TYPE DE VÉHICULE:** TMH (MOTOR HOME) / AC (AUTOCARAVANE)

**THIS VEHICLE CONFORMS TO ALL APPLICABLE STANDARDS PRESCRIBED UNDER THE CANADIAN MOTOR VEHICLE SAFETY REGULATIONS IN EFFECT ON THE DATE OF MANUFACTURE - CE VÉHICULE EST CONFORME À TOUTES LES NORMES APPLICABLES EN VERTU DU RÈGLEMENT CANADIEN SUR LA SÉCURITÉ DES VÉHICULES AUTOMOBILES EN VIGUEUR À LA DATE DE FABRICATION.**

## Canadian Recreational Vehicle Length Label

For the Canadian market, a dual language recreational vehicle length label is located on the most forward passenger side door.

For Class A motorhomes, this location description applies to the main right-side entrance door.

### THOR MOTOR COACH

**NIV#/VIN#:** XXXXXXXXXXXXXXXXX / **SERIAL:** XXXXXXXXXXXXXXXXX  
**THORMOTORCOACH.COM**

Longueur hors tout du véhicule de loisirs **XX' X" (XXm)** tel que fabriqué  
Recreational vehicle overall length **XX' X" (XXm)** as manufactured

## Canadian Cargo Carrying Capacity Label

For the Canadian market, a dual language Cargo Carrying Capacity (CCC) (English/French) label is affixed to the driver's-side door jamb for Class B and C motorhomes and near the driver's seat for Class A motorhomes.

This label states the cargo carrying capacity (in kilograms) of the motorhome and is calculated with full freshwater holding tanks, including a full hot water heater, if applicable.

CARGO-CARRYING CAPACITY: XXX KG.	CAPACITE DE CHARGEMENT: XXX KG.
CALCULATED WITH THE Freshwater TANKS FULL (COLD): XX KG. (HOT): XX KG.	CALCULEE AVEC LES RESERVOIRS D'EAU DOUCE PLEINS (FROID) XX KG. (CHAUD) XX KG.
AND THE WASTEWATER TANKS EMPTY	ET LES RESERVOIRS D'EAUX USEES VIDES.
MASS OF WASTEWATER TANKS FULL: XX KG.	MASSE DES RESERVOIRS D'EAUX USEES PLEINS: XX KG.
V.I.N./N.I.V.: XXXXXXXXXXXXXXXXXXXX	

## Canadian Weight Label / Statement of Compliance

For the Canadian market, a dual language (English/French) weight label is affixed to the driver's-side door jamb for Class B and C motorhomes and near the driver's seat for Class A motorhomes.

(both front and rear), tire size, tire weight rating, and proper tire inflation. This label states that the motorhome conforms to all applicable standards prescribed under the Canadian Motor Vehicle Safety Regulations in effect on the date of manufacture.

This label concisely states the gross vehicle weight rating (GVWR) of the motorhome, along with the gross axle weight rating (GAWR)

MANUFACTURED BY/FABRIQUE PAR: THOR MOTOR COACH, INC.		OFFLINE: MM/YY	
GVWR/PNBV: XXXX KG (XXXXX LB)	Received: XX/XX/XXXX	SERIAL: XXXXXXXXXXXXXXXX	
DESIGNATED SEATING CAPACITY/NOMBRE DESIGNE DE PLACES ASSISES: (X) X 68 = XXXXKG		MODEL: XXXX	
<b>GAWR/PNBE KG(LB)</b>	<b>TIRES/PNEU</b>	<b>RIMS/JANTE</b>	<b>COLD INFL. PRESS./PRESS. DE CONFL. A FROID</b>
FRONT/AVANT: XXXX (XXXX)	XXXXXX/XXXXXX	XXX X XX	XXX KPA(XX PSI)
REAR/ARRIERE: XXXX (XXXX)	XXXXXX/XXXXXX	XXX X XX	XXX KPA(XX PSI)
TAG/ARRIERE: X			
THIS VEHICLE CONFORMS TO ALL APPLICABLE STANDARDS PRESCRIBED UNDER THE CANADIAN MOTOR VEHICLE SAFETY REGULATIONS IN EFFECT ON THE DATE OF MANUFACTURER - CE VEHICULE EST CONFORME A TOUTES LES NORMES APPLICABLES EN VERTU DU REGLEMENT CANADIEN SUR LA SECURITE DES VEHICULES AUTOMOBILES EN VIGUEUR A LA DATE DE FABRICATION			
V.I.N./N.I.V.: XXXXXXXXXXXXXXXX		TYPE OF VEHICLE/TYPE DE VEHICULE: MH (MOTORHOME)/AC (AUTOCARAVANE)	

# 5

## Weighing Your Motorhome

When loading cargo, be sure weight is distributed evenly to prevent overloading front to back and side to side. Heavy items should be placed low and as close to the axle positions as possible. Too much weight loaded on one side or the other may overload tires and cause handling issues.

Periodically weigh the motorhome at a public vehicle scale to determine axle loads. Certified public or commercial vehicle scales can be found at moving and storage lots, farm suppliers with grain elevators, gravel pits, recycling companies, and large commercial truck stops.

To weigh the motorhome correctly, measure the fully loaded vehicle axle by axle and wheel position by wheel position. Allow adequate time, since the entire weighing process can take around 30 minutes. There may be a small fee for each weight reading taken, but the expense is a worthwhile investment toward the safe operation of your motorhome.

The motorhome must be weighed fully loaded, which includes passengers, food, clothing, fuel, water, propane, supplies, etc. Any towed vehicle (car/pickup, boat, or trailer) or items loaded on brackets on the back of the motorhome should also be included in the weighing process.



Reading A: Front



Reading B: Total Coach



Reading C: Back

Thick Black Lines in the illustrations above represent a vehicle weighing scale.

The following procedure is suggested when using a long platform scale, although any method recommended by the scale operator that correctly determines weight value is acceptable. During all measurements, it is important to keep the vehicle as level as possible.

1. Pull onto the scale so that only the front axle is on the platform with the end of the scale midway between the front and rear axles and record the weight (**Reading A**).
2. Pull forward until the full unit is on the scale and record the weight (**Reading B**).
3. Pull forward so that only the rear axle is on the scale and record the weight (**Reading C**).
4. To determine the weight of individual wheel positions, repeat the previous three steps, but this time, use only one side of the motorhome on the scale. Record the weight readings.
5. To calculate the wheel position weight for the opposite side of the motorhome, subtract these weight readings from weight readings A, B, and C recorded in steps 1, 2, and 3.

### Other factors to consider:

- The motorhome must remain as level as possible on the scale, even though an axle or side is not physically on the scale. To obtain the side-to-side weight measurements, there must be enough space on either side of the scale to allow the motorhome to be partially off the scale.
- For improved accuracy, Thor Motor Coach recommends using a segmented 4-pad scale, when possible, to determine individual wheel weight measurements. The corner weight measurements should not exceed half of the respective Gross Axle Weight Rating (GAWR) or the maximum load rating for the tire or set of dual tires at the rear, whichever is less.
- Individual wheel position weight measurements must not exceed the maximum tire load capacity. The maximum load rating for the tire can be found embossed on the tire's sidewall.
- If any of the corner weight measurements exceed half of the listed GAWR or tire ratings, redistribute or remove a portion of the cargo until the weight is within the proper limits for all four corners of the vehicle.
- Periodically check and adjust cargo weight to obtain optimum mileage from tires and to optimize vehicle handling. Inflate tires as recommended on the Federal Weight Label affixed to your motorhome.

## Weight Distribution

Proper loading and weight distribution are extremely important factors of safe motorhome travel. An overloaded motorhome is difficult to drive and hard to stop. In cases of serious overloading, brakes can fail completely, particularly on steep hills. Proper weight distribution also affects tire performance, while overloading can cause premature wear to the vehicle's engine, transmission, and drive train components. The load a tire will safely carry is a combination of its size, its construction, its load range, and corresponding inflation pressure.

Improper weight distribution, or too much weight on the motorhome's suspension system, can cause failure or damage to:

- Springs and suspension components
- Shock absorbers
- Brakes
- Tires
- Steering components

## Loading Your Motorhome

Always consider proper vehicle loading when preparing for travel. By not overloading the motorhome and keeping the weight balanced side-to-side and as close to the axles as possible, the drivability and safe handling of the vehicle will be maximized.

- **NEVER OVERLOAD THE MOTORHOME.** Always observe and stay under the GVWR and OCCC ratings.
- Distribute cargo side-to-side so the weight on each tire does not exceed one-half of the GAWR for either axle.
- Store and secure all loose items inside the motorhome before traveling. Overlooked items such as canned goods, small appliances on the countertop, cooking pans on the range, or free-standing furniture items can become dangerous projectiles during a sudden stop.
- When traveling, keep the quantity of fresh, gray, and black water within the storage tanks to a minimum. This reduces the total weight of the motorhome, therefore increasing available carrying weight for other items (refer to Occupant cargo carrying capacity (OCCC) of the motorhome).
- Give careful attention to where and what type of flammable materials are stored and transported. Certain storage areas are clearly labeled **DO NOT STORE COMBUSTIBLE MATERIALS**. Be sure all canisters are secure and leak free. **DO NOT TRANSPORT LP TANKS OR CANISTERS INSIDE THE VEHICLE** (see Propane Section).
- For traveling safety, it is important to make sure tie down straps on appliances, furniture, and cargo (inside the vehicle) and cargo (outside the vehicle) are secured and remain tight.

Check straps regularly to ensure they have not loosened during travel.

- Be sure not to overload roof racks with cargo that is heavier than the load-carrying capacity of the roof rack system.
- When towing a trailer or vehicle, be sure to stay under the towing capacity of the motorhome and that the added weight remains under the GCWR for this motorhome.

*NOTE: At approximately 8 pounds per gallon, water can add a considerable amount of weight to your motorhome. Additional cargo carrying capacity for other items can be obtained by reducing the amount of fresh and wastewater carried while traveling.*

*However, it is recommended to always keep a few gallons of water in the black tank to help prevent the build-up of sludge, which can lead to wastewater system blockages.*

## Loading Motorhomes with Rear Cargo Door

### WARNING

- **Failure to properly stow, secure, and prevent movement of cargo can result in death or severe injury.**
- **The hauling and storage of fuel and fuel-powered equipment or vehicles is prohibited. Failure to adhere to this prohibition can lead to death or severe injury.**
- **Exceeding the vehicle's Occupancy Cargo Carrying Capacity can lead to vehicle instability, which can result in occupant death or severe injury.**

Select TMC motorhomes are equipped with a rear door that allows access to a large interior cargo area when the bed is secured in an upright position. Always follow safety warnings regarding suitable cargo types, load weight, load distribution, and cargo securing when using this space for cargo storage and transportation.

## Towing With Your Motorhome

### **⚠ WARNING**

**NEVER TOW LOADS THAT EXCEED EITHER THE TOW WEIGHT RATING AND/OR THE TONGUE WEIGHT RATING OF THE TRAILER HITCH INSTALLED ON THE MOTORHOME (Note: Tow weight is the total weight of a fully loaded trailer or towed vehicle. Tongue weight is the downward weight in pounds transferred to the hitch by the loaded trailer or towed vehicle).**

**THE WEIGHT OF THE FULLY LOADED MOTORHOME AND THE WEIGHT OF THE TRAILER, OR TOWED VEHICLE, MUST NOT EXCEED THE MOTORHOME'S GROSS COMBINED WEIGHT RATING (GCWR). Consult with your selling dealer to determine the GCWR and towing capacity of the motorhome.**

**THE DESIGNATED HITCH RATINGS MAY EXCEED THE GCWR OR OTHER TOWING CAPACITY LIMITS OF THE MOTORHOME. It is your responsibility to properly load the motorhome and trailer, while staying within the limits of the hitch ratings, GCWR, GVWR, and GAWR specified on the certification label(s) of the motorhome.**

**A SEPARATE FUNCTIONING BRAKE SYSTEM IS REQUIRED FOR CONTROLLING ANY TOWED TRAILERS OR VEHICLES WEIGHING MORE THAN 1,500 LBS WHEN FULLY LOADED. DO NOT assume the braking capabilities of the motorhome can also adequately stop the combined weight of the motorhome and towed vehicle. For specific towed vehicle braking requirements, consult your chassis owner's manual.**

**DO NOT USE WEIGHT DISTRIBUTING HITCHES OR WEIGHT DISTRIBUTING TOWING DEVICES WITH THIS MOTORHOME (applies to Class A and Class C motorhomes). The length of the chassis prevents proper weight distribution to the rear axle of the motorhome.**

**Consult your chassis owner's manual for additional information regarding towing guidelines for this motorhome.**

**Failure to heed any part of these warnings could result in loss of control of the motorhome and towed vehicle or trailer and may cause an accident and severe injury.**

### **⚠ CAUTION**

**TMC Motorhomes are factory equipped with a towing hitch and wiring harness. However, TMC motorhomes are not factory equipped with supplemental trailer braking systems. Always have trailer braking systems professionally installed and routinely inspected by a qualified technician.**

**If you are unsure of any aspect of safe towing, seek professional advice from a reputable hitch installer, trailer, or RV dealer.**

## Towing Hitch

This motorhome is equipped with a towing hitch receiver and trailer wiring receptacle. Depending on the weight rating of the motorhome's chassis, hitch ratings range from 5,000 to 10,000 or more pounds. Please refer to the chassis manufacturer's owner's manual for towing recommendations and towing limitations for this vehicle.

If you are considering towing a trailer or vehicle behind your motorhome, consult with your dealer or qualified towing expert about available towing equipment and towing options appropriate for your motorhome and travel needs.

*NOTE: Thor Motor Coach accepts no responsibility for damage to the chassis, property, and other components resulting from towing with your motorhome or towing loads greater than its designated specifications.*

## Electrical Connections for Towing

A 4-way or 7-way trailer plug, supplied by the chassis manufacturer, is pre-wired to the chassis electrical system. This plug provides electrical power for running lights, turn signals, stop lights, and electric trailer brakes. Before connecting this motorhome to any towed vehicle, verify that the wiring of the towed vehicle plug conforms to the motorhome's connector wiring.

Refer to the vehicle manufacturer's owner's manual for additional information regarding vehicle towing.

### 7-Way Connector Wiring

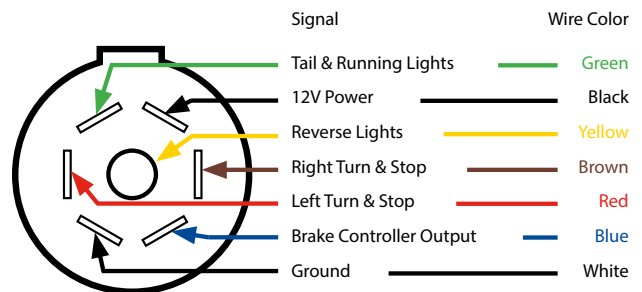

### 4-way Connector Wiring

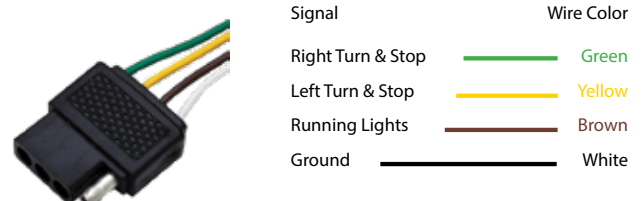

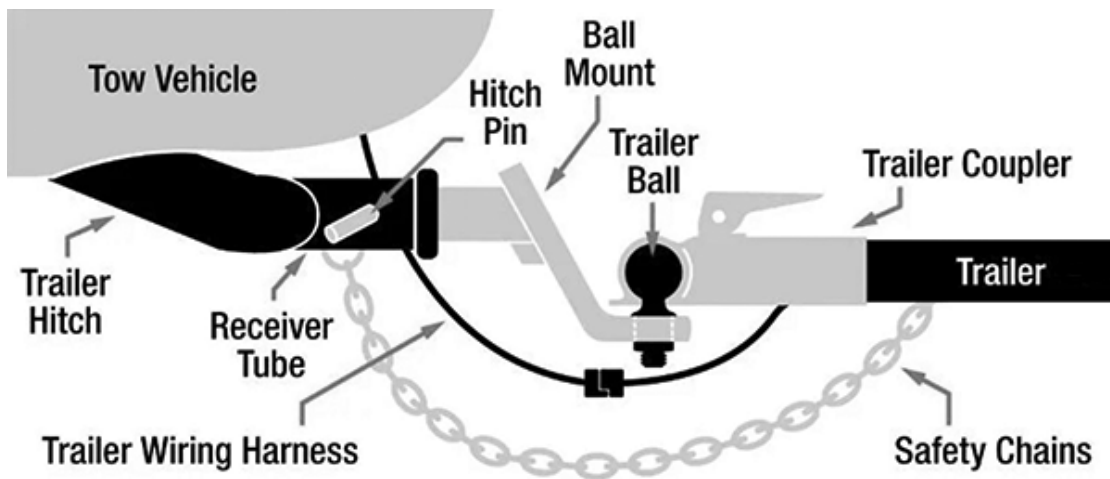

Typical towing components

## Towing a Vehicle with Your Motorhome

There are three basic methods of towing a vehicle with this motorhome; all have advantages and disadvantages.

1. **Flat towing with a tow bar.** With this method, a vehicle-specific tow bar is attached to front of the towed vehicle and the tow-hitch is attached to the motorhome. All four wheels of the towed vehicle remain on the ground. This method does not add tongue weight to the motorhome, which is an advantage. However, it is not recommended to back-up with a tow bar due to the likely-hood of jack-knifing the towed vehicle.
2. **Towing with a tow dolly.** A tow dolly is designed to be used with a variety of vehicles; therefore, the advantage is that it is not a vehicle-specific piece of equipment. Tow dollies place one set of the towed vehicle's axles on the dolly, while the other set of axles remain on the road surface. Like the tow bar, tow dollies add minimal tongue weight to the motorhome. However, also like the tow bar, it is not recommended to back-up with a tow-dolly, due again, to the likely-hood of jack-knifing the towed vehicle.
3. **Towing a vehicle using a full vehicle trailer;** either open or enclosed. A vehicle trailer presents the advantage of backing-up and since the towed vehicle is not in direct contact with the road surface, there is no additional wear to the vehicle while it is being towed. However, like all trailers, a vehicle trailer adds tongue weight to the motorhome.

## Safe Towing Tips



**IMPORTANT! ALWAYS FOLLOW SAFE TOWING PRACTICES WHENEVER TOWING WITH THIS VEHICLE.**

- **NEVER EXCEED THE HITCH TOW RATING, THE HITCH TONGUE WEIGHT RATING AND THE TOWING CAPACITY OF THE MOTORHOME.** Exceeding the maximum towing capacity can result in dangerous handling, insufficient braking performance, or serious damage to the vehicle's suspension, engine and drive train.
- Make sure the trailer hitch is capable of handling the trailer's loaded weight.
- When loading and towing with this motorhome, **DO NOT EXCEED ITS GVWR AND GCWR.**
- There are several sizes of trailer balls available. **BE SURE THE TRAILER BALL MATCHES THE SIZE OF THE TRAILER COUPLER!**
- Always ensure the trailer coupler is properly seated and locked onto the trailer ball (see illustration).
- Always ensure the hitch pin is properly installed, securing the ball mount to the receiver tube (see illustration).
- Always use safety chains between the motorhome and the towed trailer or vehicle. Cross the chains under the trailer tongue and allow slack for turning corners. Connect the safety chains to the trailer or vehicle frame or hook retainers. **NEVER** attach safety chains to the bumper of a vehicle (see illustration).

- Always check brake lights, running lights, turn signals, and emergency flashers of the motorhome and trailer (or towed vehicle) at the start of the trip and often during the trip.

Accidents can occur if the taillights are not working or are improperly connected. While the vehicle is in PARK, have a partner stand to the rear, **but not directly behind the vehicle**, to check that the turn signals, taillights and brake lights are functioning properly.

- Always pack the trailer so that most of the weight is over the axles, yet allowing sufficient tongue weight for safe control of the trailer.

Not only should roughly 60% of the trailer's load be placed over the front half of the trailer, it should also be loaded in a way that results in a tongue weight that is between 10-15% of the total weight of the loaded trailer. Ensure weight is evenly distributed on the left and right sides of the trailer. Once the load is properly distributed and an ideal tongue weight is achieved, all cargo should be secured to prevent the load from shifting.

- Check both **TRAILER AND MOTORHOME** tires daily for proper inflation and for any unusual wear (check tire pressure with cold tires). **DO NOT** forget the inner tires of the dual tire/wheel set-up and spare tires for both the motorhome and trailer.

Tires that are not properly inflated can negatively affect handling. Further, under-inflated tires can create more rolling resistance, which not only forces the engine to work harder and consume more fuel, but also increases tire temperatures and may contribute to a blow-out. Additionally, check the speed and load rating on the tires for both the motorhome and trailer and **NEVER** exceed these limits.

- Check the trailer's hub bearings before starting a trip and often during your travels. Ensure bearings are in good order and properly greased.
- Check trailer brakes at the start of each trip and daily during travels. Smaller, lighter trailers may not need trailer brakes of any kind, but heavier trailers, or those designed to carry heavier loads, will usually incorporate a trailer brake system. If the trailer is equipped with hydraulic or electric surge brakes, make sure the emergency "breakaway" cable is properly attached to the tow vehicle. In case the trailer somehow disconnects from the hitch, this cable is designed to trigger the brakes on the trailer and quickly bring it to a halt.
- Adjust mirrors before departure. Make sure the side view mirrors are adjusted to create a clear view that extends to the end of the trailer.
- Ensure back-up cameras are in proper working order. Some cameras may be able to be placed in monitor mode, so that the towed vehicle can be observed while traveling.

- Tow bars and tow dollies generally are made to travel in a forward direction only. Most towing equipment of this type is not designed for backing. **NEVER** attempt back-up maneuvers with a tow bar or tow dolly; doing so could result in damage to the motorhome, towed vehicle or towing device.
- Be mindful of the extra length a trailer or towed vehicle adds to the motorhome. Motorhomes are long vehicles, and the added length of a trailer makes a very long combination. Be extra careful when merging into traffic or making lane changes. Allow extra time to make these maneuvers. **ALWAYS SIGNAL YOUR INTENTIONS WITH PROPER USE OF TURN SIGNALS WELL IN ADVANCE OF YOUR INTENDED MANEUVER.**
- Allow for extra braking distance caused by the added weight of a trailer or towed vehicle.
- Be extra cautious when making turns. Allow for the extra length and large turning radius caused by the added length of the trailer or towed vehicle.
- Use the aid of a spotter when backing the trailer. Be sure the spotter is always in view of your rear-view mirrors. **STOP THE VEHICLE IMMEDIATELY IF YOU CANNOT SEE YOUR SPOTTER.**
- To ensure both the driver and spotter are clear on the use of hand signals, review and practice simple hand signals with the spotter before backing the trailer or towed vehicle.
- Always chock trailer or towed vehicle wheels when disconnected from the towing vehicle (motorhome) or when parking on an incline.

Reference: GMC Tips for safe trailering and towing.

## Leveling Systems

### Hydraulic Leveling Safety

#### **DANGER**

- FAILURE TO ACT IN ACCORDANCE WITH THE FOLLOWING INSTRUCTIONS MAY RESULT IN DEATH OR SEVERE INJURY.
- READ THE ENTIRE OPERATORS MANUAL AND ALL PRECAUTIONS PRIOR TO OPERATING THIS EQUIPMENT.
- DO NOT ATTEMPT TO OPERATE THE SYSTEM WHILE THE MOTORHOME IS IN MOTION. IF THE 'JACKS DOWN' ALARM SOUNDS WHILE DRIVING THE MOTORHOME, IMMEDIATELY FIND A SAFE PLACE TO PULL OVER AND STOP. SET THE PARKING BRAKE AND WHEN IT IS SAFE, INSPECT THE LEVELING SYSTEM.

#### **WARNING**

- DO NOT OPERATE ANY SYSTEM FUNCTIONS WHILE ANYONE IS UNDER THE MOTORHOME. IF WORK UNDERNEATH YOUR MOTORHOME IS REQUIRED, SUPPORT BOTH FRONT AND REAR AXLES WITH JACK STANDS. DO NOT RELY ON THE SUPPORT OF THE LEVELING SYSTEM! FAILURE TO DO SO MAY RESULT IN DEATH OR SEVERE INJURY.
- DO NOT USE THE LEVELING SYSTEM TO CHANGE TIRES. THE SYSTEM IS DESIGNED FOR LEVELING AND STABILIZING AND IS NOT MEANT TO LIFT THE WHEELS OFF THE GROUND! LIFTING THE WHEELS OFF THE GROUND MAY RESULT IN AN UNSTABLE VEHICLE CONDITION, WHICH MAY RESULT IN DEATH OR SEVERE INJURY.
- MAKE SURE THERE ARE NO OBSTRUCTIONS IN THE 'EXTEND' OR 'RETRACT' PATHS OF THE LEVELING JACKS. KEEP ALL PEOPLE AND PETS CLEAR OF THE MOTORHOME WHILE OPERATING THE LEVELING SYSTEM. ALWAYS VISUALLY CONFIRM THE JACKS HAVE FULLY RETRACTED BEFORE MOVING THE MOTORHOME. MOVING THE MOTORHOME WHILE THE JACKS ARE EXTENDED COULD CAUSE DAMAGE TO THE JACK SYSTEM AND THE MOTORHOME.
- NEVER EXPOSE HANDS OR OTHER PARTS OF THE BODY NEAR HYDRAULIC LEAKS. HIGH-PRESSURE OIL LEAKS MAY CUT AND/OR PENETRATE THE SKIN CAUSING SEVERE INJURY.
- ALWAYS DISCONNECT TRAILERS OR TOWED VEHICLES FROM THE MOTORHOME'S HITCH BEFORE USING THE LEVELING SYSTEM.

#### **CAUTION**

**OPERATE THE HYDRAULIC LEVELING SYSTEM ONLY UNDER THE FOLLOWING CONDITIONS:**

- Be sure all persons, pets, and property are clear of your motorhome while operating the leveling system.
- If you are operating an automatic system with occupants inside the motorhome, they must stay seated during the leveling process. Shifting weight inside the motorhome can disrupt the leveling system's sensing mechanism, while motorhome movements could cause falls or personal injuries.

#### **CAUTION**

**MOTORHOMES WITH AIR SUSPENSION:**

Before lowering (dumping) the air suspension, always ensure that the front wheels are pointing straight-ahead. Damage due to contact of the front tires with wheel wells and body panels is possible.

#### **NOTICE**

- The chosen parking site may present surface irregularities that would require leveling distances beyond the deployment stroke of the leveling jacks. Blocks may need to be placed under the jack support pads to effectively increase their stroke length; however, be aware that blocks create an unstable condition, and therefore, are not recommended. If possible, re-position the motorhome to a more flat and uniform parking area so that the use of blocks can be avoided.
- If one or more wheels remain off the ground after attempting to level the motorhome by automatic or manual leveling, move the motorhome to a more level location.
- Soft soils and surfaces may require the use of enlarged jack pads, boards, or other devices that increase the contact surface area of the jack support pad.
- For the hydraulic leveling system to operate (extend or retract), the motorhome's engine **MUST** be running with the gear selector in **PARK** and the parking brake must be **ENGAGED**.
- For **DIESEL PUSHERS ONLY**: the engine **MUST** be running, while the gear selector is in **NEUTRAL** and the parking brake is engaged.

# 6

## LCI Level-Up® Hydraulic Leveling System

The leveling system consists of three main components:

- Electronic Control Panel and Control Unit
- Hydraulic Pump Unit
- Hydraulic Jacks



Typical Leveling Control Panel (above), which may contain an LCD read-out. Although differing in style, all LCI Leveling System Panels operate very similarly to one another. Hydraulic pump assembly (below).

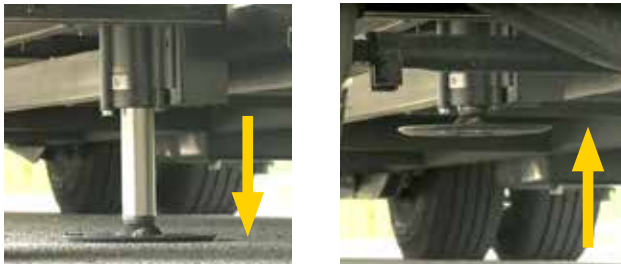

Hydraulic jacks in DOWN and UP position (above). Hydraulic pump assembly (below).



The Control Panel is conveniently located near the driver's seat in Class A motorhomes. This control panel is often located near the entrance door or Monitor Panel on Class C motorhomes. The hydraulic pump is located in an outside service bay or rearward, between the chassis rails. The leveling system has been calibrated by the manufacturer and can be operated in Automatic or Manual Mode.

The leveling system installed on this motorhome is designed to provide safe and reliable vehicle leveling and stabilization. However, due to the functions of a leveling system, which consists of moving parts, high-pressure hoses, cylinders, and components under heavy load stresses, please observe all safety instructions listed here and in the manufacturer's instruction manual.

The following instructions are general and apply to a range of leveling systems. Your leveling system control panel may look different than what is illustrated here but will function similarly. For more detailed operating and maintenance information, refer to the manufacturer's instruction manual included with your TMC Owner's Packet and on-line TMC Owners Resource service.

### To Extend:

1. Park the motorhome on a reasonably level surface.
2. If towing a trailer or vehicle, disconnect it from the motorhome's hitch and chock trailer or towed vehicle's wheels.
3. Engage the motorhome's PARKING BRAKE.
4. Start the motorhome's engine and place the motorhome's transmission in:
  - a. NEUTRAL for rear mount diesel engine vehicles.
  - b. PARK for Class A and Class C front engine gas or diesel motorhomes.
5. Turn ON the master battery switch.
6. Turn OFF all unnecessary electrical devices. Doing this while keeping the motorhome's engine running will help ensure the hydraulic pump motor has adequate electrical power.
7. FOR DIESEL PUSHERS WITH AIR SUSPENSION: Slide the air suspension lever to the LOWER position, thus lowering the motorhome's suspension. Proceed with leveling only after the motorhome is completely lowered.



Air Suspension Control Lever

NOTE: Ensure front wheels are pointed straight-ahead; otherwise, tires could contact wheel arches.

8. Push ON/OFF button on Control Panel. The system is now operational and the electronic level lights will become active.
9. Push the AUTO LEVEL button to begin the automatic leveling cycle. The system will automatically level the vehicle. The control panel will send out a series of beeps to let the operator know that AUTO-LEVEL is operating. When completed, the panel will signal a 'Successful Auto Level.' After ten minutes, the panel will enter sleep mode.

NOTE: Some panels indicate 'Successful Leveling' by illuminating a green light located in the center of the four jack buttons.

10. Push ON/OFF button to de-energize the system and turn OFF the motorhome's engine, keeping the parking brake engaged.



**IMPORTANT! NEVER COMPLETELY LIFT A WHEEL OR WHEELS OFF THE GROUND WITH THE LEVELING SYSTEM. THIS CREATES AN UNSTABLE CONDITION.**

**Inspect each tire of the motorhome to ensure they are not lifted off the ground. If Automatic Leveling causes one or more wheels to be off the ground, all the jacks must be retracted and leveling must be performed manually.**

#### NOTES:

- When parked on soft surfaces, the use of jack pads is recommended. Jack pads can be easily made from 3/4-inch-thick plywood, cut into 12 to 16-inch squares or circles. DO NOT place or retrieve jack pads while the jack rams are in motion.
- As the system is leveling the motorhome, you may experience a certain amount of motorhome movement; up and down, and side-to-side. This movement is normal as the system automatically adjusts the hydraulic jack rams.
- During the automatic leveling cycle, it is very important that you and passengers do not move around in the motorhome until the unit is level and either the LCD display indicates "Successful Leveling" or the green LCI logo light illuminates in the center of the touchpad. Failure to remain still during the leveling cycle could influence the leveling performance of the system.
- Even when fully retracted, hydraulic jacks can restrict overall ground clearance. This is particularly noteworthy for Class C motorhomes. To prevent damage to hydraulic jacks, be cautious when driving in rutted terrain, over speed bumps, or over road curbing.

#### To Retract:

### CAUTION

#### BEFORE RETRACTING THE LEVELING SYSTEM:

- Ensure that all slideout rooms are fully retracted BEFORE retracting leveling system.
  - Ensure all people and pets remain clear of the jacks and from underneath the motorhome.
  - Remove any equipment or items that may have been stored underneath the motorhome.
  - Always visually confirm that the jacks have fully retracted before moving the motorhome.
1. Ensure the motorhome's gear selector is in PARK and the parking brake is ENGAGED.  
For Class A Diesel Pushers ONLY: the motorhome's gear selector must be in NEUTRAL and the parking brake must be ENGAGED.
  2. START the motorhome's engine and keep it running while operating the leveling system.
  3. Turn ON the master battery switch.
  4. Energize the system by pushing ON/OFF button on the control panel. The LED or LCD screen will display JACKS DOWN.
  5. Push the RETRACT button and the jacks will automatically retract. If the controller has an LCD screen, select AUTO RETRACT by pressing the up and down buttons, then press ENTER.
  6. When the JACKS DOWN display or LED goes off, the jacks are fully retracted. Push the ON/OFF button on the Control Panel to de-energize the system.
  7. Perform a visual inspection around the motorhome to verify the jacks are fully retracted.
  8. FOR DIESEL PUSHERS WITH AIR SUSPENSION: Return the Air Suspension Lever to the AUTOMATIC position.

To stop the jacks from retracting, turn the system off and back on again by pushing the ON/OFF button twice.

To retract in MANUAL Mode, push the RETRACT button until it lights. By pushing any of the JACK buttons, the jacks will retract in pairs, i.e., FRONT, REAR, LEFT, RIGHT.

## Manual Leveling with a Hydraulic Leveling System

You may encounter conditions where automatic leveling of the motorhome cannot be accomplished. If possible, retract the jacks and re-position the motorhome to a more level parking area. If that is not possible or feasible, try leveling the motorhome manually by deploying the jack rams in pairs.

1. Follow all hydraulic leveling system safety precautions before and during operation of the leveling system.
2. Start the motorhome's engine, ensuring the parking brake is engaged and the transmission is in:
  - a. Neutral for Class A Diesel Pushers;
  - b. Park for Class A and Class C front engine gas or diesel motorhomes.
3. Press the ON button on the Leveling System Control Panel.
4. Press either the FRONT or REAR button on the Control Panel. Depending on which switch is pushed, either the front or rear pair of jack rams will deploy. Release the switch when the jacks contact the ground (you should feel the motorhome slightly rise).
5. Press the opposite switch and hold until the motorhome rises slightly. Watch the control panel for an indication that the motorhome is level front-to-back.
6. Press either the LEFT or RIGHT button on the Control Panel (this will move the left or right-side pair of jack rams). Watch the control panel to determine if the controller can sense that the motorhome is level left-to-right.
7. If needed, press the opposite side switch while watching the control panel for an indication that the motorhome is level left-to-right.
8. Repeat this process, FRONT-to-BACK and LEFT-to-RIGHT until the controller indicates the motorhome is level.
9. Turn OFF the Leveling Jack Control Panel; turn off the motorhome's engine, while keeping the parking brake engaged.



**IMPORTANT! NEVER COMPLETELY LIFT A WHEEL OR WHEELS OFF THE GROUND WITH THE LEVELING SYSTEM. THIS CREATES AN UNSTABLE CONDITION.**

**Inspect each tire of the motorhome to ensure they are not lifted off the ground. If Automatic Leveling causes one or more wheels to be off the ground, all the jacks must be retracted and leveling must be performed manually.**

*NOTE: Jacks always operate in pairs, i.e., Right Pair, Left Pair, Front Pair, Rear Pair. Pushing the corresponding control button operates both jacks.*

## Zero Point Calibration

The hydraulic leveling system was calibrated at the factory with an unloaded vehicle. This is known as Zero-point calibration and is the point where the system will return the jacks when an auto-leveling cycle is initiated.

Vehicle loading and other factors can make it necessary to re-calibrate the Zero-point. Refer to the manufacturer's operation guide for further information regarding calibration and maintenance procedures.

*NOTE: Complete manufacturer's instructions regarding the operation, maintenance and system diagnostics of the hydraulic leveling system installed on your motorhome are available through your on-line TMC Owners Resource account:*

## Hydraulic Fluid Recommendations for LCI Leveling Systems

### CAUTION

**DO NOT use ATF Type F fluid. Type F ATF is not compatible with LCI hydraulic system seals.**

Operating conditions:

The following automatic transmission fluid (ATF) recommendations for use in Lippert Components, Inc. (LCI) hydraulic systems are based upon hydraulic system operation in various environmental air temperatures.

1. Above Freezing - Operation at air temperatures routinely above 32 °F (0 °C)—above freezing—which also covers most initial OEM fills.
  - a. Dexron® III/Mercon® ATF
  - b. Super ATF from Phillips 66
  - c. Mercon® V ATF
  - d. Dexron® VI ATF
  - e. PetroBlend (Mason City, IA) PHO 0022S (synthetic group 3 base blend)
  - f. Bellman all temp 22 (Bremen, IN)
  - g. Or any ATF or hydraulic fluid with a pour point lower than -44 °F (-42 °C).
2. Below Freezing - Operation at air temperatures routinely below 32 °F (0 °C)—below freezing.
  - a. Mobil 1™ full synthetic ATF
  - b. Royal Purple® full synthetic ATF
  - c. Valvoline™ full synthetic ATF

- d. Amsoil® full synthetic ATF
  - e. PetroBlend (Mason City, IA) PHO 0022S (synthetic group 3 base blend)
  - f. Bellman all temp 22 (Bremen, IN)
  - g. Multivis (all temperature) ISO 22 hydraulic fluid
  - h. Mobil 1™ 0W-16 synthetic motor oil
  - i. Or any ATF or hydraulic fluid with a pour point lower than -49 °F (-45 °C).
  - j. Or any ATF or hydraulic fluid (conventional or synthetic) with a pour point lower than -51 °F (-46 °C).
3. Extreme Cold - Operation at air temperatures routinely below 0 °F (-18 °C)—extreme cold.
    - a. Kendall® Hyken Glacial Blu
    - b. Benz oil (Milwaukee, WI) Flomite 530
    - c. Mobil 1™ 0W-16 synthetic motor oil
    - d. Or any conventional or synthetic ATF or hydraulic fluid with a pour point less than -71 °F (-57 °C) and viscosity less than 2850 cP (3282 cSt) @ -40 °F (-40 °C).

## Preventive Maintenance

The LCI Level-Up Motorhome Leveling System is pre-filled, primed, and ready to operate direct from the manufacturer. Automatic Transmission Fluid (ATF) with Dextron III or Mercon 5 or a blend of both is recommended for use with the system.

1. Check Fluid in reservoir every 12 months. If fluid is clear, red color, do not change. If fluid is milky, pink, and murky, and not clear red in color, drain reservoir and add new fluid.
  - Check fluid only when all jacks are fully retracted.
  - When checking fluid level, fill to within 1/4 to 1/2 inch of fill spout.
2. Inspect and clean all Power Unit electrical connections every 12 months. If corrosion is evident, spray unit with WD-40 or equivalent water-dispersion spray.
3. Remove dirt and road debris from jacks as needed.
4. If jacks are down for extended periods, it is recommended to spray exposed leveling jack rods with a silicone lubricant every three months for protection. If your motorhome is located in a salty environment, it is recommended to spray the rods every 4 to 6 weeks.

*NOTE: Phillips 66 Super ATF can also be used in your hydraulic jack system and is compatible with Dextron III ATF.*

## Troubleshooting

*If Auto-leveling is not operating correctly:*

- Make sure the main battery disconnect switch is ON.
- Make sure there is adequate power to the leveling system.
  - Are the auxiliary batteries charged?
  - Is the parking brake engaged?
  - Is the transmission in the correct position?
  - Is the engine running?
- The Leveling Jacks Control Panel may have timed-out. Turn engine ignition Off, then back ON.
- Turn the Leveling Jacks Control Panel OFF, then back ON.
- Check the circuit breaker to the hydraulic pump (usually located near auxiliary battery). Reset if tripped.
- Check the hydraulic fluid reservoir. If low, refill to proper level; do not overfill.

*If Jack Fails to Retract or Once Retracted, Slowly Drops:*

If a jack fails to remain retracted (up) or slowly drops, there is likely a leak in one of the hydraulic lines (hoses) or fittings. In order to drive the vehicle, the jack must be secured in the **UP** position with a strap, rope, zip ties, or other mechanical device.



**IMPORTANT! DO NOT USE THE HYDRAULIC LEVELING SYSTEM UNTIL REPAIRS HAVE BEEN PERFORMED.**

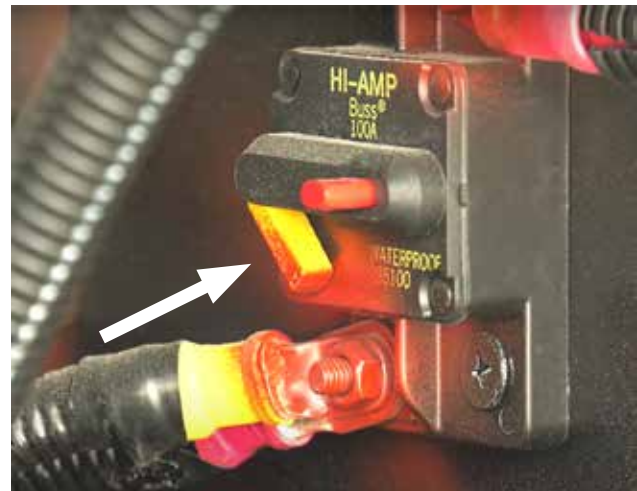

One Hundred Amp circuit breaker. Flip yellow lever UP to re-set.

## LCI Basecamp Hydraulic Jacks for Class C Motorhomes

### **WARNING**

- **Failure to follow instructions provided in this manual and all manufacturer's instructions may result in death, serious personal injury and/or severe product and property damage, including voiding of the component warranty.**
- **During servicing make sure that the coach is supported according to the manufacturer's recommendation. Lift the coach by the frame and never the axle or suspension. Do not go under the coach unless it is properly supported. Unsupported coaches can fall causing death or personal injury or product or property. Use proper personal protective equipment damage.**

### **CAUTION**

- **Always disconnect trailers or other towed vehicles from the motorhome's towing hitch before leveling the vehicle.**
- **Keep hands and other body parts clear of moving jacks and fluid leaks. Oil leaks in the leveling system may be under high pressure and can cause serious skin penetrating injuries.**
- **Never lift the motorhome completely off the ground. Extending the jacks so that one or more wheels are not touching ground will create an unstable and unsafe condition.**
- **Always wear eye protection when performing service, maintenance or installation procedures. Other safety equipment to consider would be hearing protection, gloves and possibly a full face shield, depending on the nature of the task.**

LCI's Basecamp Hydraulic Leveling System is specifically designed for Class C motorhomes. This leveling system may be offered as standard or optional equipment on select TMC motorhomes. The hydraulic system includes four points of contact, utilizing four jacks and a four-valve hydraulic control unit. A 12-volt DC electric motor drives a hydraulic pump that moves fluid through a system of hoses, fittings, and jacks to level and stabilize the motorhome.

*NOTE: Read and understand all instructions before operating the leveling system. Adhere to all safety labels affixed to the jacks, control unit, and listed in the manufacturer's instructional booklets. This manual provides general operating instructions, but does not contain information for manual operation, maintenance, calibration, and other important system details.*

For additional information for the LCI Basecamp leveling system, please refer to the manufacturer's instructions available from the manufacturer's website and through your TMC Owner's Resource account.

You can also contact TMC's Customer Care or the manufacturer's customer service team for any questions or concerns you have regarding this leveling system.



**IMPORTANT! Failure to correctly follow the provided instructions may result in death, serious personal injury, severe product and/or property damage, including voiding of the manufacturers or TMC's limited warranty.**

### Prior to Operation

The leveling system is only operational under the following conditions:

1. The motorhome is parked on a reasonably level surface with the **ENGINE RUNNING**. This helps ensure adequate 12 volt power for the hydraulic system.
2. The motorhome's transmission is in **PARK**.
3. Parking brake is **ENGAGED**.
4. The Master Battery Switch is **ON**.

### Operating the Hydraulic Jack System

This system operates similar to the hydraulic jack system described in the previous section. **Follow the EXTEND and RETRACT instructions.**

1. From the Home Screen, Press AUTO LEVEL on the control panel to extend the jacks. Whether operating in Auto or Manual mode, the 4 separate hydraulic jacks extend in pairs; Front pair, Rear pair, Left side pair, and Right side pair. In Auto mode, you will feel the motorhome lift front-to-back, and side-to-side while the controller optimizes leveling.
2. From the Home Screen, Press RETRACT JACKS to retract all 4 jacks simultaneously.

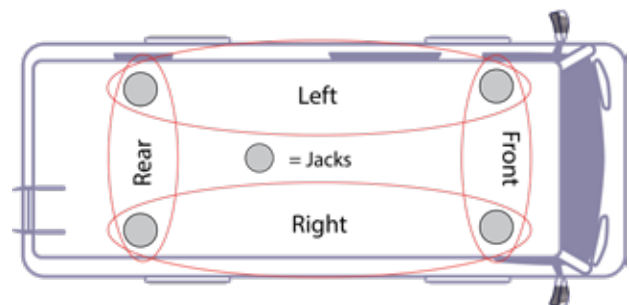

Hydraulic Leveling Diagram indicating jacks operate in pairs.

### Touchpad Controller Functions

*NOTE: The Touchpad Controller is only ON while the motorhome's ignition is ON. No operation of leveling is allowed without an ignition source. Parking Brake MUST be engaged for the system to operate.*

**Figure 1:** Is the **HOME SCREEN**, which displays whenever the HOME Button is pressed (Fig. 1A) or when the motorhome's ignition is ON. From this screen, **AUTOMATIC LEVELING** and **RETRACT JACKS** is selectable (Fig. 1B, Fig 1C).



Figure 1

**Figure 2:** Pressing the **MENU BUTTON** (Fig. 2A) shows the **MENU SCREEN** selections.

- Fig. 2B, **MANUAL MODE**: ability to extend jacks in pairs.

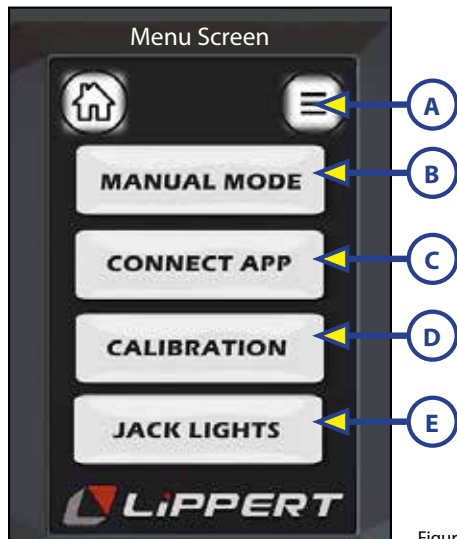

Figure 2

- Fig. 2C, **CONNECT APP**: with phone Bluetooth on, click button to search on phone for 'Auto Level, Basecamp' or similar.
- (Fig. 2D) **CALIBRATION** is a required step to program the control's orientation and define a level plane. Initial calibration will be set by OEM but operator may perform calibration again at a later date to ensure the system is at a level plane.
- (Fig. 2E) **JACK LIGHTS** on/off button, turns on all LED lights located on the front and rear crossbars, close to each of the jacks. Lights are optional and this button may not be used.

**Figure 3:** Shows the **MANUAL MODE** selections. Each button controls a pair of jacks (front pair, rear pair, left side pair, right side pair).



Figure 3

**Figure 4:** The screen message, **LEVELING IN PROGRESS** is displayed during the **AUTO LEVELING** process.



Figure 4

**Figure 5:** During the 'Auto Level' process (Fig. 1B), the **LEVELING ERROR** screen may appear (Fig. 5). The controller senses; (1) movement in the motorhome during leveling process, (2) too much time has passed, or (3) if control was calling to extend pair of jacks but saw zero movement (angle change) meaning the cylinders have reached full stroke, or (4) the motorhome is parked on too great of an incline (typically over 6 degrees) and cannot complete level process. Press Home (Fig. 5A) or Menu (Fig. 5B) icons to exit this page.



Figure 5

**Figure 6:** During the 'Retract Jacks' (Fig. 1C), or in 'Manual Mode', (Fig. 2B), the **JACKS ARE RETRACTING** screen is displayed.

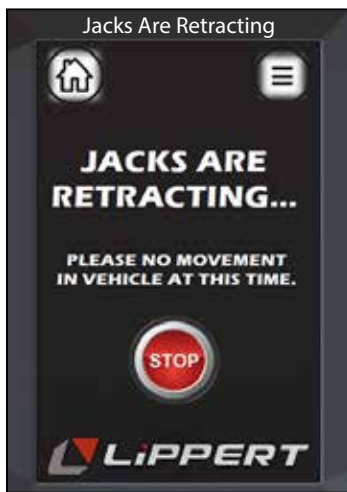

Figure 6

**Figure 7:** The **PARKING BRAKE ERROR** screen will appear when no parking brake signal is received and there is no pressure switch signal indicating jacks are still retracted. Screen message displays before auto level and manual mode functions. The error message is displayed for five seconds, then returns to home screen (Fig. 1). If jacks are extended and parking brake signal is lost, jacks will automatically retract.



Figure 7

**Figure 8:** The **INSUFFICIENT VOLTAGE** screen may be displayed before or during "Auto Level", "Retract Jacks", or "Manual Mode" functions. This error message displays when the system controller is receiving less than 10.7 volts.



Figure 8

**Figure 9:** The **RETRACT ERROR** screen (Fig. 9) will appear if the controller senses that a single or multiple jack did not fully retract. Errors are triggered by pressure sensors within the system. If the controller receives a signal from the pressure sensor (meaning the internal pressure of the hydraulic system has dropped below 2,150 psi, or there is some other fault in the system), the controller enters a ‘Retract All Jacks’ mode. If pressure switch does not open back up after 10 seconds, the audible alarm can be signaled (2 seconds on, two seconds off, 70-85 decibels). The jacks will stop retracting and the **RETRACT ERROR** screen is displayed.

The audible alarm will sound until the motorhome’s ignition is turned off or pressure switch opens up indicating that optimal pressure is reached. **HOME** (Fig. 9A) or **MENU** (Fig. 9B) buttons can be pressed to silence the alarm.



**IMPORTANT! DO NOT IGNORE THE ALARM. THERE MAY BE A JACK DOWN OR A COMPONENT FAILURE; POSSIBLY MAKING IT DANGEROUS TO DRIVE.**

**ALWAYS LOOK UNDERNEATH THE MOTORHOME TO CONFIRM ALL JACKS HAVE FULLY RETRACTED BEFORE MOVING THE MOTORHOME. OPERATOR CAN USE THE HOME OR MENU ICON AND REACH “RETRACT JACKS” FUNCTION.**

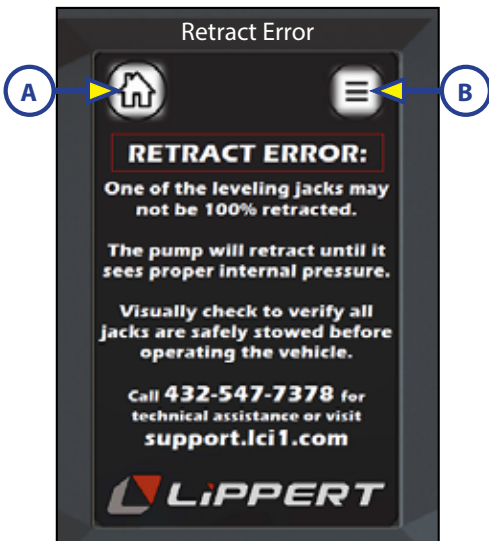

Figure 9

**Figure 10:** The **LEVEL SUCCESS!** screen is displayed, accompanied by an audible chime (3 seconds long), after the **AUTO LEVEL** function has successfully leveled the motorhome. This screen stays active for 5-10 seconds, then returns to the **HOME** screen (Fig. 1).



Figure 10

### Audible Alarms

The LCI Basecamp Hydraulic Leveling System has two audible alarms:

- **Parking brake alarm**, enabled from software while ignition is on, display is in sleep mode or on, related to loss of signal from parking brake (user dis-engages parking brake) while pressure switch signal is received (jacks are down). Alarm to sound two seconds ON, two seconds OFF, repeat until ignition off or signal is received from parking brake or signal is lost from pressure switch (indicating jacks retracted) for software to shut off alarm.
- **Leveling complete chime**, small collection of chimes or light beeps to indicate to user that leveling has successfully completed, can be tied to “Leveling Success!” screen. Only few seconds long.

## Preventative Maintenance Procedures

1. Change fluid in RESERVOIR ONLY when contaminated.
  - a. Check fluid level only when jacks are fully retracted.
  - b. Always fill the reservoir with the jacks in the fully retracted position. Filling reservoir when jacks are extended will cause reservoir to overflow into its compartment when jacks are retracted.
  - c. When checking fluid level, fluid should be within ¼" of fill spout lip.
2. Check the fluid level every month.
3. Inspect and clean all external electrical connections every 12 months. If corrosion is evident, spray electrical connections with WD-40 or equivalent.
4. Remove dirt and road debris from jacks, hydraulic and electrical connections, and pump unit as needed.
5. If jacks are down for extended periods, it is recommended to spray exposed leveling jack rods with a silicone lubricant every three months for protection. If your coach is located in a salty environment, it is recommended to spray the rods every 4 to 6 weeks.

## Fluid Recommendation

Type "A" Automatic Transmission Fluid (ATF) is utilized and will work. ATF with Dexron III® or Mercon 5® or a blend of both is recommended by Lippert.

In colder temperatures (less than 10° F) the jacks may extend and retract slowly due to the fluid's molecular nature. For cold weather operation, fluid specially formulated for low temperatures may be desirable.

*NOTE: Additional information for the LCI Basecamp Hydraulic Leveling System is available from the manufacturer's website and through your TMC Owner's Resource document service.*

Hydraulic Leveling and Slideout information courtesy of Lippert Components, Incorporated (LCI).

## Electric Stabilizers

### WARNING

- **Use the stabilizing system only for its intended purpose; it is not designed to be a leveling system, nor is it designed to carry the full weight of the motorhome. System forces and pressures can cause severe injury or death if used improperly.**
- **Service work on the system or its components should only be performed by a qualified technician.**
- **Visually confirm that all stabilizer legs are retracted prior to travel. Moving the vehicle with stabilizer jacks fully or partially extended can cause damage or severe injury.**
- **Make sure there are no obstructions in the extend or retract paths of the stabilizer legs.**
- **DO NOT use the stabilizer legs to lift the unit to perform any kind of service work or to change tires. The system is designed as a stabilizing system and is not meant to lift the motorhome off the ground.**
- **Always keep people and pets away from moving stabilizer legs and components when in operation. The mechanism of the jacks can pinch or crush, causing severe injuries.**
- **DO NOT operate system functions while anyone is underneath the motorhome.**
- **DO NOT allow excessive motion in the motorhome during system operation. This could cause the improper deployment of the system.**
- **Always disconnect trailers or towed vehicles from the motorhome's tow hitch before using the electric stabilizing system.**
- **Modifications of any factory-supplied item may result in the denial of any or all warranty claims.**

### **NOTICE**

- **A stabilizer system may be equipped with a warning buzzer, which will sound if the vehicle's ignition is turned ON while the stabilizers are extended; signaling that the stabilizers are down and possible damage could occur if the vehicle is moved. Other stabilizer systems may be equipped with a signaling light, located next to the operating switch, that provides a warning that the stabilizers are down.**
- **The system motors will stop when either the weight on the stabilizers becomes too great, or when the stabilizers are fully extended.**
- **Use of blocks or other materials underneath the stabilizer pads could create an unstable condition. Attempting to extend the reach of the stabilizing system by any means is not recommended.**



Typical left and right-side electric stabilizer jacks. For most systems, the left and right-side jacks operate independently.

Electric stabilizers are offered on select TMC Class A and Class C motorhomes and may be sourced from a variety of manufacturers. If installed, the stabilizers are located along the rearward portion of the chassis, just inside the rear bumper. The operating controls are located inside the motorhome, near the entry steps, or on some motorhomes, integrated into the main multiplex control panel. Be sure the electric stabilizers are fully retracted in the up (travel) position before moving or driving the motorhome.

The following safety and operational instructions are general in nature, yet apply to most electric stabilizing systems installed by TMC.

*NOTE: For optimum performance, the system requires full battery current and voltage from the auxiliary (house) battery(ies). This will make it possible for the motor to fully extend and place the proper tension on the jacks. If the auxiliary battery(ies) is/are weak, connect to shore power or operate the generator while extending and retracting the stabilizing jacks.*

### Prior to Operating the Electric Stabilizers

- **PARK** the motorhome on a reasonably flat and firm area. Care must be taken when selecting a parking area since the system is designed to provide stabilization, rather than leveling. **Always be mindful that the motorhome must be level and stable prior to extending and retracting slideouts.** The parking surface must be firm enough to prevent the stabilizer's support pad from sinking into the ground. Use of Jack Pads (16 to 24-inch plywood squares or circles placed underneath the support pads) may be required when parked on soft surfaces.
- Place the vehicle's transmission in **PARK** and **ENGAGE** the parking brake.

- Turn **OFF** the vehicle's ignition. Most stabilizer systems have safety warning buzzers to signal that the vehicle's ignition is ON while attempting to operate the stabilizers.
- If towing a trailer or vehicle, disconnect it from the motorhome's hitch and chock trailer or towed vehicle's wheels.
- Prior to **ANY** system operation, visually confirm that the area above and below the stabilizer support pads is clear of people, pets, objects, or obstructions.
- Always **EXTEND** the stabilizers **BEFORE** extending slideouts.
- Always **RETRACT** slideouts **BEFORE** retracting stabilizers.

### To Extend:

1. Turn **ON** the master battery switch. Doing so provides power to the electric stabilizer system.
2. **PUSH** and **HOLD** the **EXTEND** switch, passenger side or driver side (down arrow). The corresponding stabilizer jack will deploy as long as the switch is held, or the stabilizer reaches its fully deployed limit. Operate the jack until the support pad contacts the ground, with a slight lifting of the motorhome, but **NOT** to where the wheels are lifted off the ground.
3. Once the stabilizer's support pad firmly contacts the ground, **RELEASE** the **EXTEND** switch.
4. **REPEAT** with the opposite side **EXTEND** switch.
5. To **INTERRUPT** the jack travel, such as stopping deployment to adjust jack pads, simply **RELEASE** the **EXTEND** switch. Continue deployment by pushing and holding the switch in the desired direction.

Typical Electric Stabilizer Switch Panel. The panel installed in your motorhome may differ from this illustration.



## To Retract:

1. Ensure the master battery switch is ON.
2. PUSH and HOLD the RETRACT switch (up arrow) until the stabilizer is fully retracted to the stowed position. Release the switch when the stabilizer motor stops.
3. Repeat with the opposite side RETRACT switch.
4. To interrupt the jack travel, such as to brush off mud or dirt from the support pad, simply release the switch. The stabilizer motor will stop.

To continue with the RETRACT cycle, PRESS and HOLD the RETRACT switch until the stabilizer jack is in its fully stowed position.

*NOTE: DO NOT attempt to move the motorhome until the stabilizers are fully retracted in their stowed position. Damage to the stabilizers, motorhome's chassis, or other components could occur.*

## Manual Override Procedure

### CAUTION

- **Always disconnect the jack motor from the electrical system prior to manually operating the system. Failure to do so can cause electricity to back-feed through the motor and cause severe damage to the system as well as void the manufacturer's limited warranty.**
- **Keep hands clear of the mechanism and use caution as the coach chassis may lower as the stabilizers are retracted.**
- **DO NOT use this procedure to over-extend the stabilizers.**
- **DO NOT use this procedure as a means of using the stabilizers as a jack to lift the motorhome's wheels off the ground.**
- **When manually extending or retracting the stabilizing system, be sure not to overly force the actuator screw.**
- **The gears can be stripped out of the stabilizer jack if the operator continues to rotate drive coupler beyond the jack's full extension or retraction.**

If an electrical problem with the stabilizing system occurs, a manual override can be performed to extend or retract the stabilizers.

1. If possible, disconnect the electrical connector(s) from the drive motor(s). Doing so will prevent induced voltages from damaging control circuitry.
2. Locate the override coupler on the end of the drive screw housing (see illustration below).
3. Place a 3/4" wrench or socket on the override coupler and turn:
  - a. Clockwise to RETRACT.
  - b. Counter-clockwise to EXTEND.



Turn 3/4" drive coupler to manually extend or retract the stabilizer.

*NOTE: Size of the drive coupler nut may vary due to manufacturers design preference.*

This illustration shows the location of the electric stabilizer drive coupler. Each side, left and right, has a drive coupler.

*NOTE: Some electric stabilizer systems require disconnecting the electrical connector to the drive motors before manually extending or retracting the stabilizer jacks.*

*NOTE: Electric stabilizers may be installed on motorhomes with a Multiplex Control System. In such applications, the control switching for the electric stabilizers is usually located on the MOTORS Control Screen, along with Slideouts and Awnings. It may be necessary to scroll down the screen to locate the control buttons for the electric stabilizers.*

*NOTE: Complete instructions regarding the operation and maintenance of the electric stabilizer system installed on your motorhome are available through your on-line TMC Owners Resource account.*

## Slideouts

### LCI In-Wall® Slideout Systems

#### **⚠ DANGER**

DO NOT MOVE OR DRIVE YOUR MOTORHOME WITH SLIDEOUT(S) EXTENDED.

WHEN EXTENDING AND RETRACTING SLIDEOUT(S), KEEP PEOPLE, PETS, AND OBSTRUCTIONS CLEAR OF THE SLIDEOUT(S); BOTH INSIDE AND OUTSIDE OF THE MOTORHOME.

#### **⚠ WARNING**

THE SLIDEOUT SYSTEM, WHICH CONSISTS OF MOTORS, CONTROLLERS, AND RELATED HARDWARE IS INTENDED FOR THE SOLE PURPOSE OF EXTENDING AND RETRACTING THE SLIDEOUT ROOM OR ROOM EXTENSION. ITS FUNCTION SHOULD NEVER BE USED FOR ANY OTHER PURPOSE.

TO USE THE SYSTEM FOR ANY OTHER PURPOSE OTHER THAN WHAT IT IS DESIGNED FOR MAY RESULT IN DEATH, SEVERE INJURY OR DAMAGE TO THE MOTORHOME.

#### **⚠ WARNING**

DO NOT MOVE OR DRIVE YOUR MOTORHOME IF THE SLIDEOUT MOTORS ARE DISCONNECTED FROM THE SLIDEOUT CONTROLLER OR IF THE MOTORS HAVE BEEN DISCONNECTED FROM THE GEAR TRACK.

If it is necessary to move the motorhome in these conditions, secure the slideout with travel bars, slide locks, or other means in order to prevent slideout movement.



Slideouts provide expanded and roomy interior living space

#### **⚠ CAUTION**

##### BEFORE OPERATING SLIDEOUT(S):

- Park on a level area and if installed with leveling or stabilizing system, level or stabilize the motorhome with the jacks in the down position.
- Ensure that children and pets are kept well away from moving slideouts.
- Always inspect the area outside the slideout prior to operating to safeguard that the slideout will not contact nearby trees, vehicles, utility poles, or other obstacles.
- Gear tracks present a severe pinch hazard; keep hands away from moving slideouts.
- Ensure that the interior floor and space is clear of any obstacles that could impede slideout travel or become entrapped under the slideout or slideout rollers.
- If equipped, remove travel bars or slide-locks prior to operating slideout(s).
- Engage emergency (parking) brake and keep the parking brake engaged while the vehicle is parked and the slideout(s) is/are extended.

#### **NOTICE**

- With slideouts that are located just behind the cockpit, place driver and front passenger seats in the most forward position and place the seat backs in the upright position; otherwise slideout may contact and damage seat backs and/or slideout motion will be inhibited.
- When extending and retracting slideouts, you must maintain pressure on the control button continuously while the slideout is in motion. Avoid stopping and starting the motors during slideout travel.
- It is important to continue to press the slideout switch for a few seconds after the slideout is fully extended and until the motors shut off. The controller will sense that the room has stopped and will shut the motor off automatically. This operation keeps the motors synchronized.
- If the slideout motors are not synchronized, the slideout will likely bind while extending or retracting. If binding occurs, STOP OPERATING THE MOTORS; the motors or gear tracks could be damaged. The slideout motors will need to be re-synchronized and the slideout may need to be manually retracted. Refer to the manufacturer's instructions for resynchronizing motors and manual override instructions.
- Routinely inspect the slideout awning for damage; it provides important weather protection. Also ensure the awning operates properly, extending and retracting with the slideout.

- For the slideout system to operate (extend or retract), the motorhome's engine **MUST** be running with the gear selector in **PARK** and the parking brake must be **ENGAGED**.
- For **DIESEL PUSHERS ONLY**: the engine **MUST** be running, while the gear selector is in **NEUTRAL** and the parking brake is engaged. These actions ensure that the slideout has adequate 12-volt power to operate properly.

## NOTICE

You may encounter parking areas where exact leveling is impossible and getting your motorhome close-to-level is the best that can be achieved. During these situations, consider using your motorhome with the Slideouts **IN** or **NOT** extended. The inconvenience of using your motorhome while a slideout is not extended is better than risking skewing or damaging a slideout due to an unlevelled motorhome.

TMC motorhomes may be designed with one or more room slideouts and/or partial room extensions. Slideouts and room extensions dramatically increase the usable interior space of the motorhome when it is parked, creating a more comfortable living space for you and your fellow travelers. And when retracted, maintains the motorhome's excellent road manners.

Before extending the slideout, check around and above the exterior of the motorhome to be sure the slideout will not come in contact with anything outside when it is fully extended. Also check the interior of the motorhome to be sure that slideout travel is free from obstructions.

For more detailed operating, emergency operating, and maintenance information, refer to the manufacturer's instruction manuals available through your on-line TMC Owners Resource service.



Varying by model and floor plan, slideout room extensions offer travelers convenient and comfortable interior space enhancements while parked.



The slideout control switch supplied on your motorhome may be located on the main system panel (illustrated above) or found on the Slides/Awning menu screen of a multiplex touchscreen panel (below). Some floor plans will have slideout extend and retract control switches mounted on a wall near the slideout.



*Important procedures for effective slideout operation:*

1. **Level the motorhome:** Doing so will keep the slideout square and help to prevent binding in the slideout opening. Always level the motorhome before extending slideouts and keep the motorhome level and stationary until slideouts are retracted.
2. **Provide sufficient power to the slideout motors:** Doing so will aid in proper slideout motor operation. Slideout motors can draw a significant amount of current from the house battery(ies). All TMC motorhomes require the vehicle's engine running to operate slideouts (parking brake must also be set, along with the transmission in Park; Neutral for Class A Diesels). This provides extra power to the house batteries via the vehicle's alternator. If the slideout system has an ignition lock-out feature, TMC recommends plugging into shore power or operating the generator while extending and retracting slideouts. This will ensure the house 12 volt system has sufficient power to operate the slideout motors.

3. **Keep the slideout motors in-sync:** Doing so ensures proper slideout operation. When operating an electric slideout, always follow the procedures described in this section. This will help keep the slideout motors operating smoothly.

## Extending the Slideout

*After completing the exterior and interior inspections prior to slideout operation:*

1. If installed, level the motorhome with the hydraulic leveling system or stabilize with the electric stabilizers (refer to Leveling and Stabilizing).
2. **Diesel Class A Motorhomes:** Place motorhome's transmission in NEUTRAL and apply PARKING BRAKE. Engine must be RUNNING for hydraulic and electric actuated slideouts.

**Gas Class A and all Class C Motorhomes:** Place motorhome's transmission in PARK and apply PARKING BRAKE. Engine must be RUNNING.

3. Turn the Master battery switch ON.
4. Locate the slideout operating switch (location varies per model and floor plan). If the motorhome is equipped with a multiplex system, the slideout control is located on the slideout/awning (motors) menu screen. For all other installations, slideout control switches are located on the Monitor Panel.
5. Press and hold the IN/Retract button for 3-5 seconds, then Press and hold the OUT/Extend button until the slideout is fully extended AND hold the switch for an additional 3-5 seconds, then release the switch (this procedure helps to keep the slideout motors in-sync).

## Retracting the Slideout

### CAUTION

**Before retracting a slideout, always visually inspect the roof and awning of the slideout for any debris or damage. Check the gear tracks for debris or damage. Check the weather strips and seals.**

**Before moving the motorhome, always perform an interior and exterior visual inspection to ensure slideout is fully retracted, secured, and prepared for travel.**

*Observe the same safety precautions as previously stated for slideout operation, and:*

1. Be sure there are no obstructions on the floor of the coach or in the path of the slideout.
2. **Diesel Class A Motorhomes:** Place motorhome's transmission in NEUTRAL and apply PARKING BRAKE. Engine must be RUNNING for hydraulic-actuated slideouts.

**Gas Class A and all Class C Motorhomes:** Place motorhome's transmission in PARK and apply PARKING BRAKE. Engine must be RUNNING.

3. Turn the Master battery switch ON.
4. Locate the slideout operating switch (location varies per model and floor plan). If the motorhome is equipped with a multiplex system, the slideout control is located on the slideout/awning (motors) menu screen. For all other installations, slideout control switches are located on the Monitor Panel.
5. Press and hold the OUT/Extend button for 3-5 seconds, then press and hold the IN/Retract button until the slideout is fully retracted. Continue to hold the IN/Retract button for an additional 3-5 seconds, then release the button (this action will help keep the slideout motors in-sync).
6. Install the slideout locking devices (if equipped).

## Remote Operation

Motorhomes with multiplex control systems may offer remote control of slideouts, awnings, and other motorhome functions via a smartphone app. Check with your dealer or review the multiplex system manufacturer's instructional guide for information regarding remote control features.

## Resynchronizing Slideout Motors

If the slideout motors DO NOT start and stop at the same time, the motors are out of synchronization, which can result in a jammed or inoperable slideout. The following procedure can solve most motor synchronizing issues:

1. Fully extend the slideout, keeping the actuating switch depressed until both motors stop on their own.
2. Retract the slideout a few inches, pressing the RETRACT switch.
3. Press the EXTEND switch until both motors stop on their own.
4. Repeat this procedure (fully extend, retract a few inches, fully extend) until both motors start and stop at the same time. It may be necessary to repeat this action several times before the motors re-sync.
5. Once the motors are synchronized, fully extend and fully retract the slideout, observing that the motors remain synchronized.

If performing this procedure does not re-sync the motors or restore normal slideout operations, the slideout may need to be manually retracted and slideout service may be required. Refer to the manufacturer's instructions or contact your dealer or TMC's Customer Care for additional slideout information.

#### NOTES:

- Slideouts will not operate properly if the 12-volt system's power delivery capacity is low. This is the reason the engine must be running; supplying additional power from the vehicle's alternator to ensure the slideout motors have consistent operating energy.
- For motorhomes with an ignition lock-out for slideout operation, the engine must be OFF. Connect to shore power or operate the generator prior to slideout operation to ensure adequate power from the 12-volt electrical system.
- Many slideout problems can be avoided by keeping the slideout motors in-sync. Always hold the IN or OUT switch until the slideout is completely in or out and the motors stop. Avoid releasing the switch while the slideout is partially open or closed.
- There is a 30 second delay feature on the tilt-a-bed slideout (if equipped), to allow time to raise the head of the bed.
- Even if travel bars or slide locks are not required to secure the slideout for travel, it is recommended to have some type of slideout securement device available if mechanical securement of the slideout becomes necessary.
- If the slideout becomes skewed or binds, and attempts at motor synchronizing fails, the slideout will need to be manually retracted and secured. The slideout system may require repairs. Refer to the manufacturer's instructions for motor disengagement, manual retraction, and securement procedures.
- For additional operational, troubleshooting, and slideout maintenance information, refer to the slideout documents and how-to videos available through your TMC Owners Resource on-line account:

[thormotorcoach.com/owners/](http://thormotorcoach.com/owners/)

## Transit Bars

If for any reason the slideout becomes inoperative, it may be necessary to secure the slideout in the RETRACTED position so that travel is possible. Transit bars consist of an expandable bar with protective pads on both ends. To prevent possible skewing of the slideout during transit, place a transit bar at the front and rear of the slideout.

With the slideout fully retracted, insert the transit bar along the upper side of the slideout, between the interior wall and the trim valance of the slideout. Expand the rod until it is snug. An assistant may need to push inward on the exterior of the slideout to compress the seals and make a weather-tight fit.



**IMPORTANT! DO NOT OVER-TIGHTEN THE TRANSIT BAR. DAMAGE TO THE INTERIOR FASCIA OR EXTERIOR WALL COULD OCCUR.**

During travel, occasionally inspect transit bars to ensure they have not loosened from vehicle movement.

Transit bars are available from several manufactures with a variety of features securing mechanisms. Transit bars or other types of emergency slideout securing devices are not supplied by TMC, but can be obtained through RV retailers or parts suppliers.

*NOTE: Even if transit bars are not required for normal circumstances, it is recommended to have some type of lock system available if additional securement of a slideout becomes necessary.*



Slide-Lock™ Transit Bar

## Powered Entry Steps

### **⚠ WARNING**

**WITH THE POWER SWITCH IN THE 'ON' POSITION, AND THE ENTRY DOOR 'OPEN', IT IS POSSIBLE TO DRIVE OFF WITH THE STEPS EXTENDED. SEVERE PERSONAL INJURY AND/OR DAMAGE TO THE STEPS AND MOTORHOME MAY OCCUR.**

**ALWAYS ENSURE THAT THE ENTRY DOOR IS FULLY CLOSED AND THE STEPS ARE RETRACTED BEFORE MOVING AND/OR DRIVING THE MOTORHOME.**

### **⚠ CAUTION**

- **Steps must always be operated with a fully charged battery (12-volt electrical supply).**
- **Electric steps are designed to detect obstacles in the way of operation by sensing excessive amperage. Without a fully-charged battery, the steps may malfunction, which could cause severe personal bodily injury.**
- **Prior to exiting the motorhome, always look downward to confirm that the entry steps are deployed (extended). It is possible to lock the steps in the retracted position or the steps have malfunctioned. Injuries caused by slips or falls are possible.**
- **Always use the handrails when entering and exiting the motorhome. Severe bodily injury could occur from a slip or fall.**

TMC motorhomes may be equipped with powered entry steps. Depending on the size of the motorhome, powered steps will consist of one, two, or more treads. Powered entry steps make entering and exiting the motorhome both safe and convenient (as compared to manually deployed steps). When enabled, the steps automatically deploy, or lower, when the entry door is opened and automatically retract, or raise, when the entry door is closed.



Typical powered entry steps. Depending upon motorhome model, steps may have one or more treads.



Typical powered entry step switch (center). Configuration may vary, however, all will be located near the entry door of the motorhome.

## Operating Powered Entry Steps

Powered steps are equipped with an ENABLE/DISABLE switch conveniently located near the entrance door, so that when parked and there is increased foot traffic in-and-out of the entry door, the steps can remain in the extended or down position. This eliminates unnecessary step deployment and retraction. When the time comes to move the motorhome, this switch should always be placed in the ON or ENABLED position, so that the steps will retract when the entry door is closed for departure.

### Normal operating mode, power switch ON:

1. Open the motorhome entry door; steps will automatically extend and lock when in the fully extended position.
2. Close the motorhome entry door; steps will automatically retract to the stowed position.

### Securing the entry steps in the EXTENDED position, power switch OFF:

1. Open the entry door; the steps should automatically extend. Look down and confirm that the steps have deployed and it is safe to exit the motorhome.
2. Exit the motorhome, while keeping the entry door open.
3. Locate the step power switch and press or turn it to the OFF position.
4. Close the entry door; the steps should remain deployed.

Returning the steps to normal operating mode:

1. Open the entry door and locate the Step Power Switch.
2. Turn the switch to the ON position.
3. While standing outside the motorhome, close the entry door; the steps should retract, confirming that the steps are in Normal Operating Mode.
4. Open the entry door; the steps should extend, confirming that the steps are in Normal Operating Mode.
5. Always confirm that the steps have retracted before driving the motorhome.

## Maintenance

Steps are equipped with self-lubricating bushings on the drive assembly and all step joints. No lubrication is necessary, yet if in extreme conditions lubrication seems necessary, a silicon-based grease or spray can be used; it will not harm the bushings.

Basic troubleshooting:

1. Check the fuse panel for a 'blown' fuse for the 12-volt circuit that powers the steps. If necessary, change the fuse.
2. The auxiliary battery may not be sufficiently charged to operate the steps. Charge the battery(ies).
3. There may be a faulty ground. Locate the ground lug(s); clean the connections and/or re-attach ground wires.
4. Check for bent or broken step joints or arms. The step mechanism may be binding when attempting to extend or retract.
5. The step motor or motor module may be faulty. Repairs will need to be made at an RV service center.

NOTES:

- *If there is an electrical failure to the steps, they may be manually retracted by removing the two bolts that hold the step arm collars to the drive shaft. With these bolts removed, manually push the steps closed. The steps may need to be tied to the framework in the retracted position to keep them in-place while traveling to a repair center.*
- *Be cautious whenever the steps are inoperable; physical injury could occur due to falls or missteps. Always use the handrails when entering and exiting the motorhome.*

## Awnings

### CAUTION

**TO PREVENT PERSONAL INJURY, DAMAGE TO THE AWNING, OR MOTORHOME:**

- **Retract all awnings during periods of strong winds or threatening weather.**
- **DO NOT drive during periods of high winds or severe storms. Doing so may cause damage to the awning as they could possibly unfurl from their stowed position.**
- **DO NOT move or drive the motorhome with the awning in the extended position. Always retract the awning completely before moving the motorhome.**
- **Keep hands away from awning mechanisms while in operation. Mechanisms present pinch points that can cause severe injury.**
- **Keep all sources of heat and flame away from the awning canopy. Fabric is not fireproof.**

### **NOTICE**

- **Awnings must operate from a fully charged 12-volt system. If the house batteries are weak, plug into shore power or operate the generator so that full 12-volt system energy is available for awning operation.**
- **If awnings are rolled up wet, open them back up as soon as possible to allow them to dry. Stowing damp awnings can make conditions favorable for mold and mildew formation.**
- **When leaving the motorhome unattended for a length of time, retract the awning to avoid damage due to unexpected weather conditions.**
- **DO NOT hang or attach items to the awning. Awnings are not designed to support additional weight. Damage to awning arms and mechanisms could occur.**
- **In the event of power loss or awning motor failure, motorized awnings can be manually retracted (refer to the awning manufacturer's owner's manual for instructions).**

## Patio Awnings

Awnings can create a pleasant outdoor space that provides shade from the sun and semi-protection from certain weather conditions. Most patio awnings operate from the motorhome's 12-volt DC electrical supply. However, the awnings installed on some Class A diesel motorhomes operate from the 120-volt AC system.

For DC operated awnings, the master battery switch must be ON. If the auxiliary battery(ies) are not fully charged, turn ON the generator or plug into shore power prior to operating the awning. For AC operated awnings, the generator or shore power will need to be ON prior to operating the awning(s).



To extend the awning:

1. Before extending the awning, ensure there are no obstacles in the path of operation.
2. Provide power to the awning by turning ON the master battery switch, or operate the generator, or connect to shore power (see reference to 12-volt DC and 120-volt AC above).
3. Press and hold the EXTEND switch, located near the entrance door, or on the multiplex touchscreen panel, or remote (see note), until the awning is opened to the desired setting.

To retract the awning:

1. Before retracting the awning, ensure there are no obstacles in the path of operation.
2. Provide power to the awning by turning ON the master battery switch, or operate the generator, or connect to shore power.
3. Press and hold the RETRACT switch, located near the entrance door, or on the multiplex touchscreen panel, or remote (see note), until the awning is fully retracted.

**NOTES:**

- Some awnings feature ONE TOUCH operation. If equipped, a single press of the extend or retract button will operate the awning.
- For added convenience, some awnings are equipped with a remote control. In addition, many multiplex systems offer remote control of awnings and other electrical systems via a smartphone or tablet app.

- Refer to the awning manufacturer's instructions for additional operational, maintenance, and cleaning recommendations.

## Entry Door Awnings

Select Class A diesel motorhomes are equipped with an entry door awning. Generally, if the patio awning operates on 120-volts AC, then the entry door awning also operates on 120-volts AC. Follow the operating procedures listed above.

Observe the same awning operational cautions when extending and retracting an entry door awning as when operating a patio awning.

## Rear Awnings and Awning Pre-wire

Select TMC motorhomes are equipped with either a powered or manual rear awning. Typically installed on toy-hauler Class A or Class C motorhomes, rear awnings provide shade and weather protection for the rear door when it is used a patio deck.

Additionally, select TMC motorhomes are pre-wired from the factory so that a dealer or customer-installed powered rear awning can be easily installed. Consult with your dealer for awning pre-wire details.

## Awning Lights

The patio awning may be equipped with LED strip lighting or other lighting types. These lights are controlled by a switch located near the Awning EXTEND/RETRACT switch, or on the multiplex touchscreen panel, or on a remote-control or Bluetooth-linked device.

## Slideout Awnings

All slideouts are equipped with an awning that automatically extends and retracts with the extension and retraction of the slideout. These awnings provide protection for the top of the slideout from environmental debris (leaves and twigs), rain, and snow. Although slideouts have weather seals, the slideout awning adds an extra measure of protection, making it possible to retract the slideout without first cleaning off its top. While traveling, the slideout awning has an auto-lock feature that prevents wind from billowing or unwinding the awning. When parked and it is time to deploy the room slideout, the auto-lock feature unlocks—making manual locking and unlocking unnecessary.

As part of your routine exterior inspection, check slideout awning(s) for proper operation and potential damage. Refer to the TMC Awning, Leveling, and Slideout System Guide for care and maintenance information.

## Storage Compartments

### WARNING

#### CARBON MONOXIDE OR SUFFOCATION DANGER EXISTS

- **Exterior storage areas and compartments are not intended for human or animal occupancy. Failure to follow these instructions could lead to death or severe injury.**
- **DO NOT allow children to enter or to play in or around this storage area.**
- **This area is not heated or cooled. Do not store perishables or items in this cargo area that may be damaged by heat or by exposure to cold temperatures.**

### WARNING

- **Storage compartments have load limits. DO NOT exceed load limits posted on warning labels. Distribute the weight evenly and DO NOT overload.**
- **When closing the compartment storage doors, make sure that hands and fingers are clear of pinch points. Make sure all compartment doors are completely closed and latched, and all contents are properly secured prior to moving the motorhome.**

Exterior storage compartments provide a convenient and secure location to stow travel items and equipment. Most exterior storage bays are equipped with lockable latches. Some are equipped with lights, tie-downs, or other convenient features.

When storing items in the compartment bays, **DO NOT** overload them with heavy packed items. Remember that any carry-on items or equipment placed in storage compartments affects the overall weight of the vehicle. Ensure that the side-to-side loading is balanced and distributed evenly. Please refer to Section 5, Weighing, Loading, and Towing.

*NOTE: Items placed in exterior storage compartments may shift during travel.*



TMC Class A and Class C motorhomes are designed with convenient outside-accessible storage compartments. Total storage capacity depends on class, brand, and floor plan.



## Exterior Kitchen Unit

### **⚠ DANGER**

**DO NOT** put griddle in storage or travel mode immediately after use. Allow griddle to cool to touch before moving or storing.

Failure to do so could result in fire, resulting in property damage, personal injury, or death.

### **⚠ WARNING**

When using the outdoor kitchen and cooking area:

- The vehicle must be level and stabilized.
- **DO NOT** violate manufacturers' instructions on required clearances for cooking appliances during use.
- **DO NOT** store cooking appliances until cool to the touch.

**Can lead to a fire and explosion and result in death or severe injury.**

When equipped, the exterior kitchen unit provides a convenient outdoor food preparation and clean-up station. The outside kitchen unit is accessed by an exterior compartment door, located at the rear, camp-side of the motorhome. Compared model-to-model, the kitchen unit may contain different features, such as: a sink, with hot and cold running water, a refrigerator, and a GFCI 120-volts alternating current (AC) receptacle. Also located along the right-side rear, most TMC motorhomes provide a convenient propane (LP) gas connection for a portable grill or other gas appliance.

Use caution whenever a LP gas appliance is connected and in-use. Inspect the gas supply hose for any cracks or damage. **DO NOT** use if damaged in any way. Inspect the burners, they could have shifted out-of-place during transport. Keep the appliance well away from the side of the motorhome or other flammable materials. Always turn OFF the gas supply when appliance is not in use. Instruct children to stay clear of hot devices and allow adequate time to cool before stowing away any cooking device or appliance.

#### NOTES:

- *DO NOT* put solid particles down the drain of the exterior kitchen sink. Solid particles could clog the drainpipes and the wastewater holding tank.
- Exterior Kitchens with pull-out griddle will include a lift-up storage door that is clad with stainless steel. This cladding is designed as a heat shield and should **NEVER** be removed or replaced with a flammable material.



Examples of optional exterior kitchens. Depending on floor plan options, exterior kitchens may include: cabinet storage, refrigerator, sink with hot and cold running water (see above), pull-out gas griddle, water sprayer with hot and cold water (see below).



## Pull-out Exterior Griddle

### **DANGER**

#### IF YOU SMELL GAS:

- Turn off gas to the appliance.
- Extinguish any open fires or flames.
- If smell continues, walk away from the appliance and call a fire department at once.
- If a fire should occur, keep away from the appliance and immediately call the fire department.
- **DO NOT ATTEMPT TO EXTINGUISH AN OIL/GREASE FIRE WITH WATER.** Water can spread an oil/grease fire.
- **NEVER CHECK FOR GAS LEAKS WITH AN OPEN FLAME!**

Failure to follow these instructions may cause a fire or explosion which may cause property damage, personal injury, or death.

### **DANGER**

#### NEVER OPERATE THIS APPLIANCE UNATTENDED

- When operating this appliance, maintain a minimum clearance of 6 inches from each side and back of unit to any combustible materials.
- **DO NOT** use this appliance within 25 feet of any flammable liquid or container of flammable liquid.
- **THIS APPLIANCE DOES NOT HAVE A PROPANE GAS PRESSURE REGULATOR.** NEVER use this appliance with an unregulated or high-pressure LP gas supply.

Failure to follow these instructions could result in fire, explosion, or burn hazard that could cause property damage, personal injury, or death.

### **DANGER**

**DO NOT** stow griddle until it is cool to the touch.

Failure to do so could cause a fire, resulting in property damage, personal injury, or death.

### **WARNING**

- Before using this appliance, visually inspect the gas hose from the LP supply to the appliance. **DO NOT USE** the appliance if the gas hose shows any sign of wear, breaks, leaks, cracks, cuts, or other damage. Replace the gas hose immediately and before using the appliance.
- **DO NOT** use this appliance if the burners, control valves, or other components are damaged or faulty in any way.

Failure to follow this warning can lead to fire, property damage, or serious injury.

### **CAUTION**

- Before using the appliance, ensure it is on a level, stable, and non-combustible surface. **DO NOT** operate the appliance on a wooden, plastic, or asphalt (blacktop) surface.
- Keep a type B-C fire extinguisher readily available when using this or other outdoor gas appliances.
- Always turn **OFF** the gas supply when the appliance is not in use.
- This appliance is designed for outdoor use **ONLY**. **DO NOT** use inside the motorhome.
- Ensure that children and pets stay well away from any gas appliance and gas hoses that are connected to the external propane hook-up port.
- **DO NOT** use the griddle in conditions of rain, snow, or other precipitation. Water coming in contact with the hot griddle can splatter, causing burns and personal injury.
- **DO NOT** use this or any other flame-producing appliance underneath an opened awning.
- Ensure the storage bay door is secured and remains a safe distance away from this appliance while in operation.
- When using the pull-out griddle, always follow the manufacturers safety instructions and the Propane safety instructions included in this manual.
- Before using the griddle, always extend the pull-out tray completely and ensure the latching mechanisms secure the tray from movement.
- The exterior LP hookup has a shut-off valve. Ensure the shut-off valve is **CLOSED** when connecting and disconnecting the gas hose to the griddle.
- The back of the griddle unit is vented and becomes extremely **HOT** when in use. **ALWAYS** route the gas hose away from the back of the griddle. **NEVER** orient the back of the griddle next to the side of the motorhome or other flammable surfaces or materials.
- Be sure the griddle is cool to the touch before sliding it back into its stowed position.
- Always secure the griddle and portable cooler/freezer with securing straps to the storage tray and ensure the storage tray is securely latched in its closed position before moving the motorhome.

### **NOTICE**

Before using the griddle for the first time, the griddle cooking surface must be seasoned. Follow seasoning procedures appropriate for cast iron cookware.

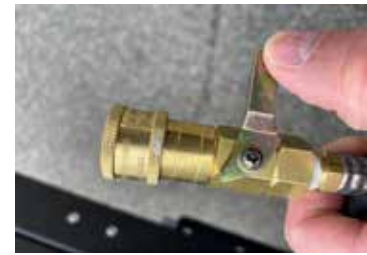

2-burner gas griddle and gas quick-disconnect coupler and gas hose with built-in valve.

Providing the convenience of an outdoor campsite cooking area, select TMC Class A and Class C motorhomes feature as standard or optional equipment, a pull-out LP gas griddle. The unit includes a slide-out tray, which makes it readily available for any exterior cooking assignment, and easily stows away when not in use. In addition, some floor plans offer a 12 volt portable refrigerator/freezer in combination with the griddle; providing a complete exterior food preparation and cold storage system.



**IMPORTANT! THE GRIDDLE IS FOR OUTDOOR USE ONLY AND IS NOT PLUMBED TO THE RV'S LP GAS PIPING. However, it is supplied with a gas hose that is designed to connect to the exterior LP hook-up port located on the right-side of the motorhome.**

- **When using the pull-out griddle, always follow the manufacturer's safety instructions and the Propane Safety instructions included in this manual (Sections 3 and 11).**
- **The exterior LP hookup (See Propane Section) has built-in shut-off valve. The supplied gas hose may also have a shut-off valve. Ensure shut-off valves are CLOSED when connecting and disconnecting the gas hose to the griddle.**
- **The back of the griddle unit is vented and becomes extremely HOT when in use. NEVER orient the back of the griddle in close proximity to the side of the motorhome or place flammable materials near the back of the griddle when it is in use.**
- **Be sure the griddle is cool to the touch before sliding it back into its stowed position.**



Typical gas hose connections and tray latch mechanisms.



## Pull-out 40 Quart, 12 Volt Cooler/Freezer

### **CAUTION**

- **Read and follow all manufacturers safety and operational instructions.**
- **Remove all protective plastic wraps and other shipping materials before use.**
- **Ensure all ventilation and cooling ports remain unblocked and unrestricted.**
- **Inspect all electrical cords and adapters for any sign of damage. DO NOT use if cords and/or adapters are damaged.**
- **The cooler/freezer must be in a horizontal position to operate. The tilt angle must be less than 5 degrees from horizontal. The unit can be tilted up to 45 degrees for a short time during portable transport. If it has been set on its side or end, the unit must be returned to a horizontal position for at least 6 hours before operating.**
- **Maintain adequate spacing around the unit for good ventilation of the compressor and internal components. The manufacturer recommends maintaining 8 inches (200 mm) of space to the back of the unit and 4 inches (100 mm) space on each side.**
- **Protect the exterior of the refrigerator from HIGH heat sources, such as the gas griddle of other hot appliances.**
- **If there is water inside the refrigerator's compartment, DO NOT turn it upside down to drain. Remove the drain plug located in the inside bottom of the unit and allow water to drain out. Re-insert the plug. Mop-up residual water with a sponge, towel, or rag.**
- **For best operation, keep the refrigerator out of direct sunlight and away from heat sources.**
- **DO NOT immerse the unit in water to clean. DO NOT allow water to intrude into the electrical components of the unit. Keep the unit upright and wipe the surfaces with damp rag and mild detergent.**
- **Disconnect the unit from power sources when not in use.**
- **There are no user-service or maintenance components. If the unit requires repair, contact TMC or the manufacturer.**
- **Always secure the griddle and portable cooler/freezer with securing straps to the pull-put tray and ensure the pull-out tray is securely latched in its closed position before moving the motorhome.**

Select TMC Class A and Class C motorhomes offer a portable 40 quart, 12 volt cooler/freezer with the gas griddle described previously. These appliances are transported on a sturdy slide-out tray that is mounted and easily stows into a rear storage compartment, making food preparation readily available for any outdoor cooking assignment.

The portable cooler/freezer has two cooling zones, which can be independently set from 50° F (10° C) to -4° F (-20° C). If desired, the zone divider can be removed so the unit can be utilized fully as a cooler or freezer. Included with the cooler/freezer are baskets for each zone, a 12 volt power cord, and a 12 volt-to-120 volt adapter. The unit is also supplied with wheels and side-mounted handles, making it campsite portable.

Electrical power for the cooler/freezer is conveniently provided by both 12-volt DC and 120-volt AC outlets installed inside the storage bay of equipped motorhomes.

*NOTE: For complete operational instructions, maintenance and other useful information on the gas griddle and the 12 volt cooler/freezer, refer to the manufacturer's instructions and TMC's Appliance and Component Guide, available through your on-line TMC Owners Resource account.*



Mounted on a convenient pull-out tray (along with the gas griddle), the 40 quart, 12 volt cooler/freezer contains two temperature controlled cooling zones and storage baskets. The zone divider can be removed, creating a large, single cooling or freezing area.

## Motorhomes with Rear Cargo Door

### **⚠ WARNING**

- **Failure to properly stow, secure, and prevent movement of cargo can result in death or severe injury.**
- **The hauling and storage of fuel-powered equipment or vehicles is prohibited. Failure to adhere to this prohibition can lead to death or severe injury.**
- **Exceeding the vehicle's Occupancy Cargo Carrying Capacity can lead to vehicle instability, which can result in occupant death or severe injury.**

Select TMC motorhomes are equipped with a rear door that allows access to a large interior cargo area when the bed is secured in an upright position. Always follow safety warnings regarding suitable cargo types, load weight, and cargo securing when using this space for cargo storage and transportation.



Typical rear cargo door shown closed and open. Cargo tie-down ring(s) and interior cargo area with the bed in an upright and stowed position are also shown.

Some illustrated features may not be standard equipment.



#### NOTES:

- Depending on floor plan features, rear beds may fold up or raise to the ceiling to create a large cargo area.
- Sports equipment and personal items shown in these illustrations are for demonstration purposes only and do not represent standard or optional equipment available from Thor Motor Coach.



**⚠️ WARNING**

**DO NOT CLIMB ON OR WALK ON THE ROOF WHILE WET, ICY, OR SNOW COVERED. THE ROOF COULD BE VERY SLIPPERY CAUSING YOU TO FALL, WHICH CAN RESULT IN DEATH OR SEVERE INJURY. DO NOT USE THE ROOF AS AN OBSERVATION PLATFORM OR STORAGE AREA, AS IT IS NOT DESIGNED FOR THESE PURPOSES.**

TMC motorhomes have plywood reinforced roofs which are strong enough to walk on, but is not designed to be an observation platform. Use the exterior ladder to climb up on the roof to inspect and maintain the roof, roofing seals, and roof-mounted components.

## Inspections and TMC's Limited Warranties

In order to maintain certain TMC limited warranties, annual inspections of the roof, roof seals, and other structural components is required. Refer to your TMC Warranty Guide, TMC Customer Care, or your dealer for warranty and inspection details. Routinely inspect the roof and roof-mounted components to make sure that all seals and sealants remain in good condition and are not cracked or worn. Proper maintenance of seals is necessary to keep moisture from entering and causing severe damage, such as rot, mold, or mildew. If drying, cracked, or weathered seals are encountered, make sure to reseal as necessary. Contact your dealer or TMC's Customer Care professionals for compatible sealants and sealing methods for the roof materials installed on your motorhome. Special sealers may be required for the skylights and other roof-mounted components. Consult with your dealer regarding warranty and roof inspections, sealing and sealant maintenance schedules.

## Factory-installed Roof-mounted Accessories

Typically, motorhomes are equipped with several factory-installed roof-mounted components and accessories. These items require routine inspection and maintenance of seals in order to prevent damaging water intrusion and to maintain certain TMC limited warranties. Consult with your dealer regarding warranty inspection requirements and routine maintenance schedules.



## Exterior Ladder

**⚠️ DANGER**

Falls from a ladder from any height can lead to death or serious physical injury. Obey safety measures and **DO NOT** use the ladder for anything other than its intended purpose.

**⚠️ WARNING****LADDER CAPACITY IS 250 lbs. MAXIMUM**

- Exceeding the maximum capacity can lead to ladder collapse and possible personal injury.
- Always face ladder and use both hands to climb slowly.
- Always wear shoes that provide good traction. Failure to comply can result in a fall hazard and result in a personal injury.

If equipped, the exterior rear ladder provides access to the roof for inspection and maintenance of the roof and roof mounted items.

- When ascending and descending the ladder, ensure the ladder is clear of debris, such as water, ice, and other slippery substances.
  - Always use both hands when ascending and descending the ladder.
  - Always face the motorhome when ascending and descending the ladder.
  - Always wear shoes that provide good traction, and do not wear sandals or other types of slip-on footwear when ascending or descending the ladder.
  - Take into consideration the additional length and height the ladder adds to the motorhome when backing up or parking the motorhome.
- Damage to the ladder or motorhome could occur if the ladder contacts an object while backing the motorhome.



Typical roof ladder

## LCI® On-The-Go Ladder Receiver

### **⚠ DANGER**

Falls from a ladder from any height can lead to death or serious physical injury. Obey safety measures and **DO NOT** use the ladder for anything other than its intended purpose.

### **⚠ WARNING**

Ensure all lock buttons are in the "LOCK" position prior to ascent or decent. Unlocked locking mechanisms may cause instability and could lead to a fall.

### **⚠ CAUTION**

Make sure ladder tabs are fully seated in the receiver (wall bracket slots) before use. If all the ladder treads are not fully extended, use **CAUTION** ascending and descending as ladder rung spacing will not be as uniform as expected.

Select TMC motorhomes are factory-equipped with LCI's On-The-Go Ladder Receiver. Installed on either the rear or side wall of the motorhome, this bracket is specifically designed to work with LCI's telescoping ladder, securing the telescoping ladder to the RV for safe ascending and descending (ladder not typically supplied by TMC). The adjustability of the telescoping ladder ensures safe ladder angles (as compared to most permanently installed ladders).

*NOTE: The TMC-installed ladder receiver is designed to be used ONLY with LCI's On-The-Go telescoping ladder. If not supplied with your motorhome, an On-The-Go telescoping ladder is available through LCI's on-line retail store, RV part suppliers, or dealers. Ladders may be available in different lengths, so be sure to purchase a ladder in the length that is appropriately sized for your motorhome.*



Illustration of LCI's On-The-Go ladder receiver

## Bicycle Rack

TMC motorhomes may be equipped with a bicycle rack attached to the rear wall. This rack allows convenient and secure transportation of one or two bicycles. For operational instructions, refer to the manufacturer's owner's guide included in your TMC Owner's Packet.



Typical bicycle rack installation

## Dealer / Owner-installed Roof and Sidewall Accessories

As part of TMC's roof design and construction, there are areas of the roof that contain reinforcements suitable for customer or dealer-installed roof accessories. Such items may include solar panels, two-way radio antennas, or satellite antenna systems. Sidewall-installed accessories include bicycle racks, bracket-mounting systems, and other aftermarket items.

Diagrams of the roof construction are available through your TMC Owners Resource on-line account. Before installing roof or sidewall-mounted accessories, consult with your dealer or TMC's Customer Care for proper mounting techniques and possible warranty requirements, restrictions, or infringements.

*NOTE: Additional information covering the operation and maintenance of exterior-mounted features and devices of your motorhome may be available through the on-line TMC Owners Resource Information Service and TMC How-to videos:*

[thormotorcoach.com/owners/](http://thormotorcoach.com/owners/)

## Ramp Door and Patio Deck Enclosures

### **⚠ WARNING**

- **NEVER** exceed the carrying capacity of the garage area and the GVWR of the motorhome.
- **NEVER** exceed the weight limits of the ramp door when it is being used as a loading ramp (down position) or as a patio, if equipped (horizontal position).
- Make sure there are no obstructions when raising, lowering, or using the ramp door. Obstructions in the ramp door's path can cause severe personal injury, equipment and/or property damage.
- Keep all people and pets clear of the immediate area while operating the ramp door. Moving parts can pinch, crush, or cut.
- **DO NOT** allow the ramp door to free-fall while being lowered. When lowering the ramp door, do not release it from the operator's grip until it rests completely on the ground.
- **NEVER** move the motorhome while the ramp door is lowered to the ground or in the patio deck position. Damage to the ramp door and/or motorhome could result.
- Always confirm the ramp door is shut and locked in the travel position before moving the motorhome.
- Always ensure that patio deck support cables are deployed evenly and not coming in contact with any obstructions. Uneven and/or interrupted deployment of the patio deck support cables can result in damage to the door and lessen the weight capacity of the cable support system.
- Regularly inspect all cables and support brackets, making sure they are securely mounted and are not damaged. Damaged cables and support brackets could cause a failure of the patio deck system, resulting in severe injury.
- To prevent falls and injuries, **NEVER** use the ramp door as a patio without the patio barriers properly installed.
- Ensure the patio rail system is secure in its mounting brackets before allowing the patio deck to be used.
- **DO NOT** sit or stand on the patio rail system. Patio rails are not designed to be load-bearing. Severe injury could result from misuse of the patio rail system.

### **⚠ CAUTION**

- **DO NOT** allow jumping, running, or rough play on the patio enclosure. Stress or failure of the mounting and/or support mechanisms could occur, which could lead to severe personal injury.
- Use caution when walking on an inclined ramp door. Slips and falls are possible that could result in personal injury.
- **DO NOT** lower or operate the ramp door on uneven ground. **DO NOT** lower ramp door into a ditch or gully to alter the loading angle of the ramp. Damage to the door, door hinge, and/or mounting brackets could result.

Thor Motor Coach Outlaw models (Class A and C) may be equipped with an optional ramp door patio enclosure. The ramp door patio consists of a patio barrier, a gate, and often an awning installed over the back of the motorhome. Some patio enclosures may include steps that can be installed to allow access to the ground level. Turnbuckles may also be installed on the ramp cables to facilitate patio leveling.

To prevent injuries due to falls, inspect ramp door cables and attachment brackets before each use to ensure the cable system is in good working order. Always use the patio barriers whenever the patio is in use and ensure all fasteners are secure. **NEVER** overload the ramp door when it is used as a patio or loading ramp.

*NOTE: Instructions for operating Class A and Class C Ramp doors and patio enclosures are provided in the TMC Outlaw Class A and C Supplement, available through your on-line TMC Owners Resource account.*



Typical Ramp Door Patio. This illustration shows a Class C model.

## Exterior Convenience Items

TMC motorhomes are equipped with several convenience items that enhance the RV experience. Described below are but a few of these items:

### Puddle Lights

Puddle lights are installed on the underneath outboard corners of Class C cab-overs. These lights are activated by the actuation of the cab dome lights, either by opening the cab doors or by turning on the cab dome light switch. Puddle lights can also be activated by turning on the parking lights.

When illuminated, puddle lights cast a beam of safety lighting around the cab entry doors, helping to ensure a safe entry and exit to the cab of the vehicle.



Puddle light on a Class C cab-over.

### Pet Tether Bracket



TMC Pet Tether.

Traveling with pets? TMC provides a convenient pet tether bracket, in the shape of the TMC Shield Logo, installed on the camp-side of every Class A and Class C motorhome.

With your pet safety tethered to this bracket, you can be sure your pet will stay out of harms way whether at your favorite campsite or stopped along the highway for a brief rest from your travels.

### Entrance Door Grab Handle

All TMC Class A and Class C motorhomes are equipped with a grab handle mounted to the left of the main entry door. This handle facilitates safe entry into and exit from the motorhome.



Entrance Door Grab Handle

### Storage Bay Cargo Trays

Available on select Class A Diesel motorhomes, storage bay trays add convenient access to stored cargo. Typically, cargo trays are installed in bays that offer pass-through access to both sides of the motorhome. The tray is equipped with a slide mechanism that allows convenient cargo access from both sides of the motorhome. Latches are installed on both the left and right sides to secure the tray during transport.



Storage bay cargo tray.

### Running Boards

Running boards may be standard or optional equipment on TMC Class C motorhomes. When equipped, running boards offer easier access to the cab for the driver and front passenger. Depending on motorhome model, running boards may be care-free aluminum or stylish fiberglass.



*This page is intentionally blank*

## Interior Lighting

The interior lighting installed in your Thor Motor Coach motorhome provides safe and convenient illumination for the living space of your RV. All interior lighting fixtures, which include ceiling, reading, accent, and safety illumination operate on 12-volts DC. Most, if not all, interior lighting comprises of energy-efficient and long-lasting LEDs.

Controls for interior lights are conveniently located on wall-mounted switch panels or on the main multiplex control panel. Multiplex systems include a master lighting control and dimming functions. Some accent lighting fixtures have a built-in push-on, push-off switch located in the center of the fixture cover.

## Operating Interior Lights

Since all interior lighting fixtures operate on 12-volt DC power, the motorhome's 12-volt DC power system must be activated.

To operate lighting fixtures by the 12-volt battery system:

1. Turn ON the main battery disconnect switch, located near the main entrance door of the motorhome.
2. Operate interior lights as needed.

To operate lighting fixtures by shore power:

1. Connect the shore power cord to an external power source.
2. Operate interior lights as needed. Power for the lights (and other 12-volt devices) is sourced through the on-board converter (located within the power load center), which transforms incoming 120-volts AC to 12-volts DC.



Efficient 12-volt LED lighting provides safe and convenient illumination in all areas of the motorhome

To operate lighting fixtures by the generator:

1. Turn the main battery disconnect switch ON (must be ON in order to start and operate the generator).
2. Operate interior light as needed. Power for the lights and other 12-volt devices is sourced through the on-board converter (located within the power load center), which transforms incoming 120-volts AC to 12-volts DC.

NOTES:

- Motorhomes equipped with a multiplex control system have the interior lighting controls integrated into the main control panel, with additional remote lighting panels located throughout the motorhome. Individual lighting icons that display an arrow are dimmable. Press and hold the light icon until the light fixture dims to the desired illumination level.
- When leaving the motorhome for longer than a few hours and not connected to shore power, it is good practice to turn off interior lighting and turn OFF the main battery disconnect switch. Doing so will prevent the auxiliary (house) battery from unnecessary discharging.

## Appliances

### WARNING

**Read and follow all warnings and safe operating instructions for the appliances installed in this motorhome. Follow all safety labels affixed to this motorhome and provided in this TMC Owner's Manual, your TMC Owner's Packet, and available directly from the appliance manufacturer.**

### CAUTION

**Always turn OFF the air conditioner, furnace, and all electrical appliances before disconnecting the shoreline power cord from the 120-volts AC power source or shutting OFF the generator.**

Please refer to the specific appliance component manufacturer's owner's manuals for safety, operation, and maintenance instructions. If the information is missing from your Owner's Packet, please have the brand, model, and serial number of your specific appliance available before contacting your selling dealership for assistance in obtaining a replacement. For your convenience, many appliance manufacturers have their component manuals available for download from their company website.

Each appliance installed in the motorhome is warranted by its manufacturer. It is very important to review ALL the literature provided in your TMC Owner's Packet. Fill out and mail any warranty registration cards as required by the appliance manufacturers. Please contact your selling dealer, TMC Customer Care, or the appliance manufacturer if you have any questions regarding the operation, maintenance, or safety of the appliances in your motorhome.

*NOTE: Due to the wide variety of appliances installed in TMC motorhomes, appliance operational instructions are not included in this manual. Individual component operational manuals are included with your TMC Owner's Packet and also available through your on-line TMC Owners Resource document service.*

[thormotorcoach.com/owners/](http://thormotorcoach.com/owners/)

## Cooktops and Ranges

### DANGER

**DO NOT USE GAS COOKING APPLIANCES FOR COMFORT HEATING. CAN LEAD TO CARBON MONOXIDE POISONING, WHICH CAN CAUSE DEATH OR SEVERE INJURY.**

**DO NOT OPERATE GAS RANGES OR GAS COOKTOPS WHILE THE VEHICLE IS IN MOTION.**

### WARNING

**GAS COOKING APPLIANCES NEED FRESH AIR FOR SAFE OPERATION. BEFORE OPERATING:**

- Open vents or windows slightly or turn on exhaust fan prior to using cooking appliance.
- Gas flames consume oxygen, which should be replaced to ensure proper combustion.
- Range covers must be open when the surface burners are in operation.
- Improper use can result in death or severe injury.

### WARNING

- Do not store combustible materials on or near gas appliances.
- Range covers must be open when the surface burners are in operation.
- Do not operate cooktops unless privacy curtains, window curtains, window blinds, or other flammable materials are safely secured away from the appliance or removed.

**MAY CAUSE A FIRE, WHICH COULD RESULT IN DEATH OR SEVERE INJURY.**

Depending on the model and floor plan, TMC motorhomes are equipped with either a gas or electric-induction cooktop (one to 3 burners) or a gas range that includes multiple gas burners and a gas oven. Induction cooktops operate on 120-volts AC, while gas cooktops and ovens require the main gas valve to be open, along with the Master Battery Switch being ON, providing 12-volts DC to the igniter, oven lights and other electrical features.

Due to the variety of cooktops and ranges installed in TMC motorhomes, operating instructions are not included in this manual. For complete operational and safety instructions for the kitchen appliances installed in your motorhome, refer to the manufacturer's instructional manuals included in your Owners Packet or available through your on-line TMC Owners Resource account.

*NOTE: Refer to the Propane System, Section 12 of this manual, for additional information about the propane appliances installed in TMC motorhomes.*

## Refrigerators

### DANGER

**TO PREVENT SPARKS AND POSSIBLE EXPLOSIONS OR FIRE, TURN OFF THE GAS/ELECTRIC TYPE REFRIGERATOR AND ITS IGNITER WHEN FUELING THE MOTORHOME OR RE-FILLING THE LP TANK.**

TMC motorhomes are factory-equipped with one or more of the following types of refrigerators:

- Residential, 120-volt AC (compressor type);
- Electric, 12-volt DC (compressor type).

Compressor type refrigerators are similar to those found in most residential homes; therefore, they may be referred to as a 'residential-type' refrigerator. These refrigerators operate on 120-volts AC and use an electric motor, which drives a compressor. Cooling is accomplished as the refrigerant cycles through phases of condensing and evaporating.

The 12-volt DC refrigerator has a compressor-type refrigeration unit, but the motor and control circuitry operate on 12 volts DC.

#### Powering refrigerators during travel:

To keep the refrigerator operating while the motorhome is either in-transit or off-the-power grid, each type of refrigerator is provided with a unique method of power. If the motorhome has a residential, 120-volt AC compressor-type refrigerator, it is equipped with an inverter that has adequate power output to operate the refrigerator via power delivered from the auxiliary batteries. Be sure the master battery switch is ON, along with the inverter. To prevent battery discharge, only operate the



Typical RV 12 volt DC electric refrigerator



Typical 120 volt AC residential refrigerator

refrigerator via the inverter when the vehicle's engine is running. While in transit or if the auxiliary battery(ies) is not fully charged, operating the refrigerator from power supplied by the on-board generator is possible.

If the motorhome is equipped with a 12-volt DC compressor-type refrigerator, it can be operated on the auxiliary battery(ies) while in-transit. To prevent severe battery drain, the motorhome will also be equipped with a stand-alone Automatic Generator Start (AGS) device (refer to AGS, Electrical Section). When ON, the AGS will automatically start and operate the generator, supplying power to the refrigerator via the on-board converter, which also supplies charging voltage to the auxiliary battery(ies).

*NOTE: AGS may also be used when operating a 120-volt AC refrigerator on the inverter. The AGS system will detect low battery voltage and automatically turn on the on-board generator, providing charging energy to the auxiliary battery(ies) via the converter.*

For complete instructions on the refrigerator supplied with your motorhome, refer to the manufacturer's instructions provided in your Owner's packet. Also, refer to the TMC Quick Start Guide, Refrigerators, available through the TMC Owners Resource on-line document service.

*NOTE: Stored food items may shift during travel. Use caution when opening the refrigerator door during and after travel.*

## Microwave and Microwave/Convection Ovens

### **⚠ WARNING**

**To reduce the risk of fire, electric shock, burns, or injury to people when using the appliance, read and follow all manufacturer's safety precautions and operational instructions before using this appliance.**

For speed and convenience of food preparation, all TMC motorhomes are equipped with a microwave oven or a combination microwave/convection oven. Microwave ovens are appropriately sized, matching the design and compactness of the motorhome's kitchen and floor plan. All microwave ovens operate on 120-volts AC, which is either supplied by shore power or by the on-board generator.

For complete safety and operational instructions for the microwave oven installed in your motorhome, refer to the manufacturer's instructions provided in your Owner's packet or available on-line through your TMC Owners Resource account.



TMC Class A kitchen featuring an over-the-range (OTR) microwave oven and 2-burner induction cooktop.

## Optional Appliances

### Dishwasher

Select TMC motorhomes may be equipped with a dishwasher as part of a completely furnished mobile kitchen. If so equipped, models and brands may vary due to manufacturers, suppliers, and individual preferences. Please refer to the manufacturer's owner's manual, included with your TMC Owner's Packet for appliance operation, care, and maintenance details.

### Clothes Washers and Dryers

#### CAUTION

**When installing a clothes washer/dryer stackable unit, be sure to follow the instructional label located in the space for these appliances. Also follow all appliance manufacturer's instructions for installation and operating of these appliances.**

Select TMC motorhomes may be equipped with a stacked clothes washer/dryer combination. If so equipped, models and brands may vary due to manufacturers, suppliers, and individual preferences. If your motorhome is not supplied with a washer/dryer combination, but is prepped (pre-wired and plumbed) for these appliances, a label, like the one below will be affixed to the closet designed for this purpose. Please refer to the appliance manufacturer's owner's manual, included with your TMC Owner's Packet for operation, care, and maintenance details.

When operating appliances such as dishwashers, clothes washers, and/or clothes dryers, be mindful of the extra demand these appliances place on your on-board electric supply, freshwater supply, and wastewater storage capacity. Although the systems of your motorhome are designed to effectively handle these appliances, experience is the best teacher for determining the effect that operating these appliances will have on the systems of your motorhome.

*NOTE: If you have any questions related to optional appliances designed for your motorhome, please contact TMC Customer Care:*

877-855-2867

#### **WHEN INSTALLING CLOTHES DRYER IN THIS CLOSET**

REFER TO APPLIANCE MANUFACTURER'S INSTALLATION INSTRUCTIONS FOR:

- a) DRYER TO BE LISTED BY THE APPLIANCE MANUFACTURER AS "SUITABLE FOR INSTALLATION" IN CLOSET LOCATIONS.
- b) VENTILATION OPENINGS (FRESH AIR) TO BE SIZED PER INSTALLATION INSTRUCTIONS.
- c) EXHAUST DUCT TO BE INSTALLED AND SIZED PER INSTALLATION INSTRUCTIONS.

**NOTE: DUE TO VARIATIONS OF DRYER MANUFACTURERS, NO DRYER VENT FRAMING HAS BEEN INSTALLED. REMOVE THIS PANEL TO COMPLETE THE DRYER VENT INSTALLATION.**

DA2182



Optional stacked washer/dryer installation (Select Class A models)

### Electric Fireplace

Select TMC Floor plans feature an electric fireplace, which not only adds a warm and inviting ambiance to the room, but is also a functional space heater. Models may be remotely controlled or by a wall switch.



## Central Vacuum System

### **⚠ CAUTION**

- **This system is designed for dry materials only. Do not vacuum damp or wet materials into the unit.**
- **Use caution when using the vacuum around children. Do not allow children to use the vacuum system as a toy.**
- **Use only with the manufacturer's recommended attachment.**
- **Do not vacuum up any materials that are burning or smoldering, such as cigarettes, matches, or hot ashes.**
- **Do not use to pick-up flammable or combustible liquids.**
- **The power unit is installed in a storage bay of the motorhome. Do not pack or stow items in close proximity to power unit. Overheating of the motor could occur.**
- **Do not use without dust bag and/or filter properly installed.**
- **Unplug and disconnect power to the unit before servicing.**

TMC Class A Diesel motorhome may be factory-equipped with a central vacuum system manufactured by Dirt Devil®. The system's power unit is installed inside a storage bay and is easily accessible to change dust bags and filters.

The central vacuum system is supplied with a vacuum hose and a selection of cleaning attachments, to make any vacuuming job a quick and easy task.



Dirt Devil CV1500 Central Vacuum

### Operation:

1. Connect the desired cleaning attachments to the vacuum hose and insert the free end of the hose to the wall mounted vacuum inlet. The power unit is automatically turned ON when the vacuum hose is inserted into the wall fixture.
2. Vacuum up dirt and debris, being cautious to not vacuum-up large or sharp objects that would potentially clog the vacuum hose.
3. If the vacuum unit is not picking up dirt and debris as it normally would, it is likely that either the dust bag is full and needs to be replaced, or there is a clog in the vacuum hose or the vacuum line leading from the wall inlet to the power unit. Cease operating the unit until the vacuum hoses are unclogged or dust bag is replaced.
4. When the cleaning job is done, simply disconnect the vacuum hose from the wall inlet and stow away the hose and cleaning attachments.

### Changing the Dust Bag:

1. The dust bag is housed inside the power unit. Remove the end cap of the power unit.
2. Slide the bag collar off the inlet, remove and dispose the dust bag.
3. While the dust bag is out of the unit, inspect the filter. If it is loaded-up with dust, remove it and wash it in warm water with mild detergent. Wring out excess water and let it the filter element completely dry before re-installing it into the vacuum canister.
4. Open a new bag and expand the pleats by gently pulling on the corners of the bag.
5. Slide the bag collar securely onto the vacuum inlet.
6. Replace the end cap onto the power unit.

### NOTES:

- *This appliance has a thermal protection device built into the motor to prevent overheating. If the motor will not operate, pull the power cord from the power receptacle, then re-insert the power plug back into the receptacle. Doing so should reset the thermal protection device.*
- *Refer to the manufacturer's instructions (available through your TMC Owners Resource on-line account) for dust bag and filter element part numbers and ordering information.*

## Entertainment Systems

TMC motorhomes are factory-equipped with many different entertainment devices, depending on motorhome model, floor plan, and available optional equipment.

For more detailed information regarding a specific component installed in your motorhome please refer to the respective component manufacturer's owner's manuals included your TMC Owner's Packet or download from the Owners Resource section of the TMC website.

### Dash Radio and Multimedia Receivers

Most TMC motorhomes are factory-equipped with a premium cockpit radio. Radio brand, model, and features depend on the class, brand, floor plan, and available standard and optional features for your motorhome.

Cockpit radio upgrades include:

- Large touchscreen display.
- Google Android Auto or Apple Car Play smartphone connectivity.
- Back-up monitor and additional side view camera monitors on select models.
- Multimedia audio sources; AM, FM, Sirius, and Bluetooth-connected devices.
- Steering wheel-mounted remote radio and camera controls.

Select cockpit radios include systems monitoring:

- Holding tank level monitoring.
- LP tank level monitoring.
- Slide-out controls.
- Generator Start/Stop and Automatic Generator Start (AGS) settings.
- Emergency Start Switch.
- Wireless systems control via Bluetooth-enabled app.

#### NOTES:

- Typically, dash radios are powered by the house battery, NOT the chassis battery. This allows the dash radio to also be used as an entertainment device while the motorhome is parked. Whether the motorhome is parked or in transit, the Main Battery Switch must be ON to operate the dash radio and its monitoring features.



TMC installs a variety of large touch-screen multimedia cockpit radios, depending upon brand and available standard and optional features.

Large touchscreens may feature no-tools-required adjustable mounts, providing up/down, swing, and rotate motions for improved driver or passenger viewing.

Dash radios may include convenient remote steering wheel control switches for safe hands-on driving. Remote steering wheel switch controls and functions depend on radio model and available features.



- See *Electrical System Monitoring* section for a description of dash radio systems monitoring features.
- With the variety brands and models of cockpit radios offered in TMC motorhomes, detailed descriptions of features and operations is beyond the scope of this owner's manual. Some radio manufacturers include operational instructions on a built-in screen menu.
- Detailed instructions for the cockpit radio installed in your motorhome are available through your on-line TMC Owner's Resource account.

component installed in your motorhome please refer to the respective component manufacturer's owner's manuals included your TMC Owner's Packet or download from your TMC Owners Resource account. Additionally, most component manufacturers offer safety and instructional literature downloads from their company website.

*NOTE: If your motorhome is equipped with an inverter, it is likely that entertainment systems are powered by and inverted circuit. Electrical diagrams for your motorhome will highlight inverted circuits and are available through the on-line Owners Resource document service.*

## Televisions

### **NOTICE**

**Televisions installed in an over-cab or near-cab location may have an ignition cut-off device that prevents the operation of the television while the engine is running. This is a safety device to prevent possible driver distraction.**

### **NOTICE**

**If installed, exterior televisions are NOT waterproof or water resistant. Care must be exercised to keep exterior televisions from water and wet weather conditions.**

**Be certain that adjustable television mounting brackets are secured prior to travel.**

TMC motorhomes are factory-equipped with many different entertainment devices, depending on motorhome model, floor plan, and options selected. Most motorhomes are equipped with one or more interior televisions, many are smart TV's. Options may include exterior televisions located on the camp-side of the motorhome. For detailed information regarding a specific



Most TMC Class A motorhomes and select Class C motorhomes are equipped with a camp-side external TV.

## USB Charging Ports

Your Thor Motor Coach motorhome is well equipped with USB-A and USB-C charging ports throughout. Located in the cab, dining, bunk and kitchen areas, these ports conveniently facilitate all your electronic device charging needs wherever your travels take you.



Televisions are installed in a variety of locations depending on floor plan and available space. Select motorhomes offer additional entertainment devices, such as exterior televisions, sound bars, and radios.



USB Charging stations are strategically located throughout the motorhome for convenient electronic device operations.

*NOTE: Charging ports are generally powered by the motorhome's 12-volt DC system. The Main Battery Switch must be ON to activate USB Charging Ports.*

*However, charging ports located on the vehicle's dash may be powered by the vehicle's 12-volt battery. Other exceptions are charging ports that are integrated with 110-volt AC wall or pop-up receptacles. These ports may require a shore power connection or the operation of the on-board generator for activation.*

## Viewing Over-the-Air or Cable TV

Most TMC motorhomes are factory equipped with an external over-the-air television/FM antenna. This antenna can be a stand-alone unit or integrated into the Wi-Fi extender.

Although installations differ in layout, most installations will include:

- A HDMI switching box;
- An antenna/cable switch panel (shown as 'Booster Plate' in the diagrams);
- A 120-volt AC electrical outlet;

To view over-the-air (OTA) TV:

1. Locate the antenna/cable switch panel. This panel will have a coax connector on it. This is the connection point to the TV from either an OTA antenna or a cable TV source.
2. If the TV has a COAX input, connect a COAX cable from this wall plate to the TV.

*NOTE: If the TV does not have a COAX input, obtain a COAX to HDMI converter box. Connect a COAX cable from the converter box to this wall plate, then connect a HDMI cable from the HDMI converter's OUTPUT to the TV's HDMI INPUT.*

3. On this panel is a push-button switch; press this switch until the green LED is ON. **An illuminated green LED indicates that the over-the-air TV antenna is powered and connected to the television input.**
4. Using the TV remote control, locate the menu that allows automatic over-the-air channel scanning; select this option. The television should begin scanning for available over-the-air television signals.
5. Once scanning is complete, use the channel selector on the television remote control to view the available over-the-air channels.

To view cable channels:

1. Locate the antenna/cable switch panel and press the push-button switch until the green LED is OFF. This indicates that the televisions are connected to the cable signal.
2. Using the TV remote control, locate the menu that allows automatic cable channel scanning; select this option. The television should begin scanning for available cable channels.
3. Once scanning is complete, use the channel selector on the television remote control to view the available cable channels.

*NOTE: If equipped, turn your TV antenna booster ON while watching local television stations (OTA); turn OFF the TV antenna booster when watching cable or satellite.*



Antenna/Cable push-button selection switch with green LED

## Cable TV Hook-up

TMC motorhomes may be equipped with a cable TV hook-up, as illustrated in the photo below. When supplied, cable hook-ups are typically installed on the driver's side of the motorhome, either on the exterior wall or inside a storage compartment. The cable TV hook-up is designed to receive a standard F-type coax connector, either threaded or push-on style.

Check with the RV park management for cable availability, hook-up, and cable turn-on details.

If you have any questions regarding the fitment and location of your motorhome's cable hookup, please contact TMC Customer Care.



Typical park-supplied cable TV hook-up located on the driver's side of the motorhome. On some motorhome models, cable coax hookups are located on the freshwater panel or inside a left-side storage bay.

### Audio/Video Distribution

For most applications, TMC uses CAT6 cabling as a means of video distribution within the motorhome. Replacing HDMI cabling, the CAT6 substitution reduces line losses and improves signal strength, creating improved audio and picture quality.

However, this cabling requires the use of a HDMI-to-CAT6 transmitter (splitter) at the video source and a CAT6-to-HDMI receiver at the TV input. Short CAT6 and HDMI cables are used to connect the transmitter and receiver devices to the A/V source and TV (see diagram below). Select TMC motorhomes are supplied with these devices, but typically, they are owner-sourced.

HDMI-to-CAT6 transmitter/receiver pairs, along with connecting cables, are available through Amazon and other retailers.

*NOTE: There are numerous commercially available video streaming devices and A/V accessories which may more readily meet your entertainment needs. Check with an A/V retailer for device options and connection details.*

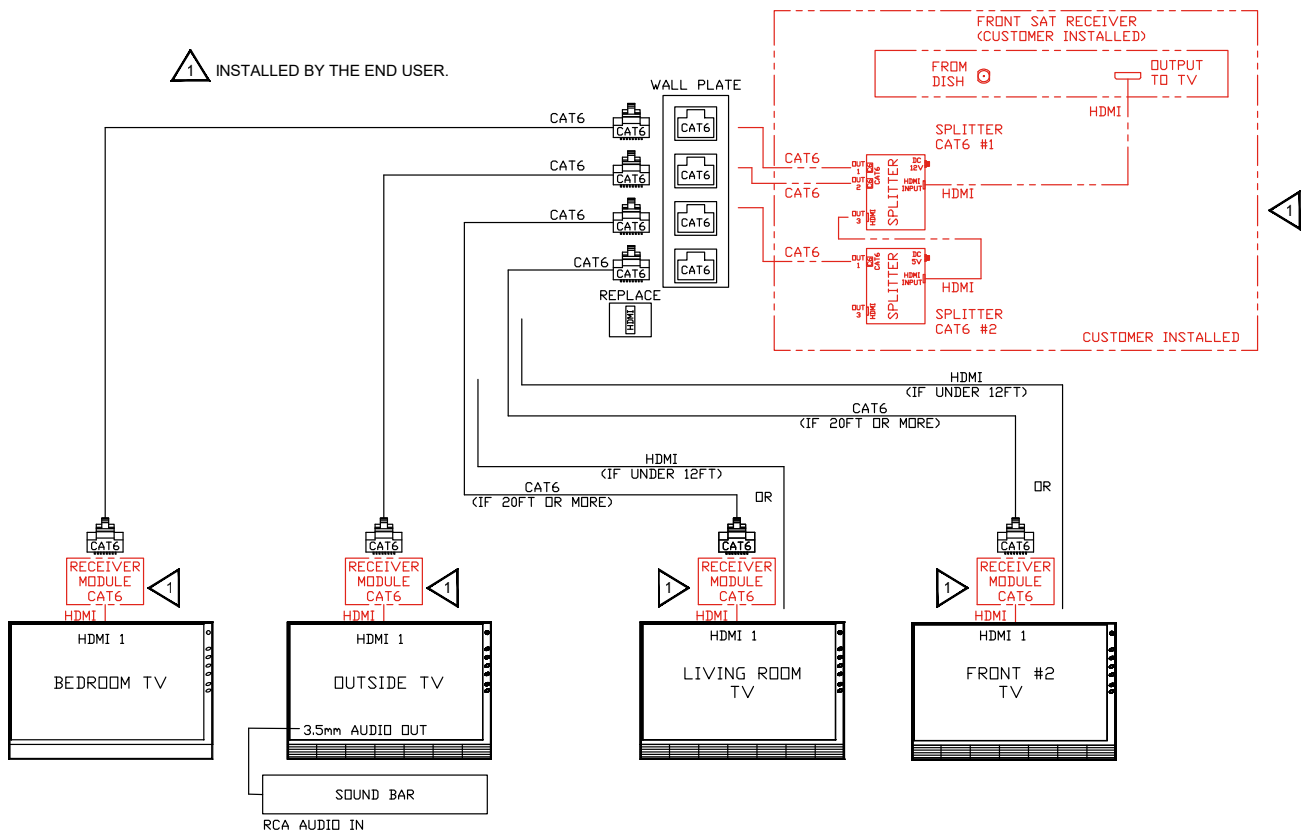

Typical Transmitter/Receiver Pair

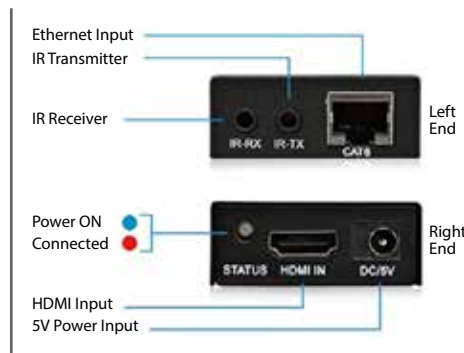

Typical Transmitter Input/Output Ports

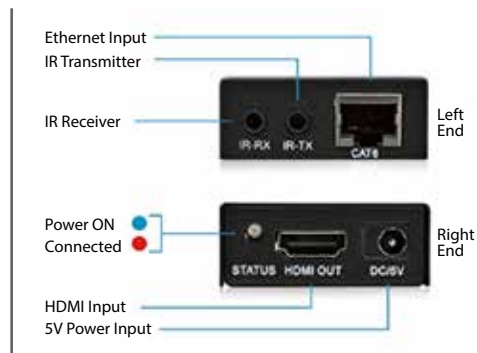

Typical Receiver Input/Output Ports

## Wi-Fi Connectivity: 4G System

Your motorhome may be factory-equipped with a Winegard Wi-Fi Extender. Designed specifically for the mobile environment, the Connect™ 2.0 is a long-range, high performance Wi-Fi extender that increases the range of existing Wi-Fi hotspots. It maximizes speed and range from both Wi-Fi and 4G LTE networks to keep users connected in all but the most remote areas. The Connect™ 2.0 will also accommodate Wi-Fi calling mode in the absence of cell signal inside the RV.



Winegard® Connect™ 2.0 Wi-Fi and 4G LTE Extender

The operation of the WiFi Extender requires set-up procedures that are unique to each unit. Consult the installation and operating guide provided by the manufacturer (included in the TMC Owner's Packet). Contact the manufacturer for technical assistance.

### Basic Operation

1. With a Wi-Fi enabled device, connect to the Connect system using the factory installed SSID and password printed on the unit's manual. If the original manual is not available, the password is printed on a label attached to the inside of the SIM access panel (located on the base of the rooftop unit).
2. After connected, open your web browser and type 10.11.12.1 and press ENTER. This will open the main log-in screen.
3. Type admin in both the Username AND Password fields. Click the CONTINUE button.
4. On the main Status screen, click on either the 4G/LTE or Wi-Fi option followed by clicking the SELECT button. If the Wi-Fi option was selected, next press the SCAN FOR Wi-Fi button.
5. A scan will take place and a list will display all access points that can be detected. Notice the Security Type and Signal Level and select an available network.
6. Enter the correct password for the chosen network (if required). When the main status page shows connected to that network, you may now use the Internet.
7. If selecting the 4G/LTE option be sure you have purchased data, otherwise you will be unable to connect to the Nationwide Winegard Network. \*

\* Each Connect system comes preloaded with 300 MB of data, and a Winegard SIM card. You will be able to initially connect via Winegard's 4G to set-up an account and buy more data. If you would prefer to use a different 4G/LTE network, the installed SIM card will need to be swapped for a SIM card from your network provider.

8. On the main Status page, click on the DATA PLAN button. To set-up an account or to purchase more data, click on the link in the SUBSCRIPTION field.
9. Either click on the CREATE ACCOUNT button or Sign-in (if you have previously created an account).
10. Fill out the Account Registration completely and then click the SAVE button.
11. Click on one of the available Data Plans and click the CONTINUE button.
12. Fill-in the payment information and click the ORDER NOW button. This will generate an email with an order number sent to the email on-file. The Connect system will be ready immediately following the Data Plan purchase.

### NOTES:

- Depending on the model, the Wi-Fi Extender installed on your motorhome may not include FM or other OTA antennas.
- If for any reason, you experience difficulties with setup or operating your Winegard Connect 5G, please contact the manufacturer for technical support:

Phone: 800-288-8094

Email: [help@winegard.com](mailto:help@winegard.com)

website: <https://winegard.com/support>

## Wi-Fi Connectivity: 5G System

Your motorhome may be factory-equipped with a Winegard Connect™ 5G Router with Wi-Fi Extender. Most units also include over-the-air (OTA) FM radio and broadcast television signal antennas. Designed specifically for the mobile environment, this unit is a long-range, high performance Wi-Fi extender that increases the range of existing Wi-Fi hotspots. It maximizes speed and range from both Wi-Fi and 5G networks to keep users connected in all but the most remote areas. The Connect™ 5G will also accommodate Wi-Fi calling mode in the absence of cell signal inside the RV.

To become operational, the Wi-Fi Extender requires set-up procedures that are unique to each unit. Refer to the manufacturer's set-up and operational guide, provided by the manufacturer and included with your TMC Owner's Packet.



Winegard® Connect™ 5G Router and Wi-Fi Extender

## Important Notes

- Set-up and operational instructions for the Winegard Connect 5G are not included in this TMC Owner's Manual. Please refer to the manufacturer's instructions, included in your TMC Owner's Packet, for complete setup and operating procedures.
- DO NOT LOSE YOUR MANUAL; it contains unique factory default SSID and password information.
- Read the manufacturer's instructions carefully and completely before attempting to operate this unit.
- Do not paint any portion of the Winegard Connect housing. Painting the housing or other system components could damage the system and will void the warranty.
- When first setting up the Winegard Connect 5G it is recommended to check for software updates once the system is connected to an Internet source. It is also recommended to check for software updates every few months to optimize your unit's performance.
- Service is for North America only and not available in Mexico. Some Winegard FreedomGO Data Plans work in the US only and some work in the US and Canada. Before purchasing a data plan, verify that it will meet your expectations.
- At the time of this writing, the Winegard Connect 5G will work with data plans from AT&T and T-Mobile. Check with Winegard Customer Service for current data plans and availability.
- Instructions for the Winegard Connect 5G are also available through your on-line TMC Owners Resource account, however important SSID and password information is only included with the manufacturer's instructions that were included with your factory-installed unit.
- If you lose your original manual or cannot find your SSID or password, this information is printed on a label located at the base of the Connect rooftop unit, directly inside the SIM card cover plate. Remove the SIM card cover plate's screws and write down or photograph the SSID and password. There is also a reset button in this location. Pressing and holding the button for 30 seconds will return the unit to its factory settings.

*NOTE: If for any reason, you experience difficulties with set-up or operating your Winegard Connect 5G, please contact the manufacturer for technical support:*

Phone: 800-288-8094

Email: [help@winegard.com](mailto:help@winegard.com)

website: <https://winegard.com/support>

**DISCLAIMER:** Although every effort has been made to ensure that the information provided to you by the manufacturer and TMC is correct and complete, no company shall be held liable for any errors or omissions in the information provided to you in this or the manufacturer's publications. If the Connect 5G antenna installed in your TMC motorhome does not function as expected, please contact Winegard Company.

## Over the Air Roof-mounted Antenna

Your motorhome may be factory-equipped with a Winegard Air 360 Omni-directional roof-mounted antenna. This antenna is specifically designed for RVs and motorhomes, providing OTA HDTV (VHF/UHF) and AM/FM radio reception. Unlike a directional antenna, it does not need to be aimed or cranked up to receive signals from all directions. This antenna provides broadcast HDTV reception from up to 50 miles, while being contained in a low-profile rooftop dome that is only 7 inches tall.



Winegard Air 360 Antenna. The installed dome may either be black or white.

## Using the Antenna:

- Ensure the antenna power supply (wall plate) is in the ON position and the green indicator light is illuminated.
- During travel and whenever your location has moved, a new scan will find any new channels that are available in your vicinity.

## How to run a channel scan (basic instructions)

1. Using the television remote, select 'Menu' and then 'Settings.'
2. Select 'Channel Setup.'
3. Select 'Antenna' or 'Air', depending on your TV. Make sure 'Cable' is not selected.
4. Select 'Channel Search' or 'Channel Scan.' Keep in mind that steps to perform a channel scan may vary. If the wording in your TV differs from these instructions, refer to your TV user manual for help.

## NOTES:

- To receive maximum programming, you have to run a channel scan after setting up the antenna or anytime your location changes.
- Running a channel scan is NOT the same as pressing Channel UP/DOWN on your remote. However, once the available OTA channels have been located and saved, only these channels should be found with the TV's remote Channel UP/DOWN buttons. Refer to your TV's user manual, available through your TMC Owners Resource account.
- The inclusion of an AM antenna is only offered in some models. The Air 360 does not provide WiFi, 4G, or 5G reception.

*This page is intentionally blank*

## Safety Notices

### **⚠ DANGER**

The sleeping accommodations in this vehicle are designed for occupancy **ONLY** while the vehicle is **NOT** in motion. All occupants in this vehicle must be seated at a designated seating position and must always wear seatbelts while this vehicle is in motion. Failure to do so can result in death or severe injury.

### **⚠ WARNING**

- The powered over-cab bunk must be completely raised and secured in the travel position before driving the motorhome. Always travel with the driver and passenger seats in the fully upright (non-reclined) position.
- **DO NOT USE THE BUNK FOR STORAGE.** Using the bunk for storage may prevent the bunk from fully retracting, therefore preventing the placement of the safety pins or securing devices.
- **NEVER LOWER OR OCCUPY OVER-CAB BEDS WHILE THE VEHICLE IS IN MOTION.**

### **⚠ CAUTION**

#### BEFORE OPERATING ELECTRIC BED:

- Remove travel locks (safety pins) and recline driver and front passenger seat backs.
- Close all cabinet doors and remove other items from underneath the bunk that might inhibit downward travel.
- Ensure children and pets stay well away from underneath and from moving mechanisms and gear tracks of the bunk while it is in motion.

### **⚠ CAUTION**

#### XXX LBS. MAX LOAD CAPACITY FOR THIS BED

- Failure to comply with the load capacity could cause bed failure which can result in injury.
- Elevated beds can present a fall hazard which may result in injury.
- **DO NOT** allow adults, children, or pets to occupy drop-down beds or bunks while the lift mechanism is in operation.
- Due to the risk of falls, it is recommended that children ages 6 or younger **DO NOT** sleep or occupy over-cab bunks.
- The use of bunk rails or nets is recommended whenever children occupy an over-cab bunk.

TMC motorhomes are designed with a variety of sleeping accommodations. Many floor plans feature permanent queen and king size beds, while others feature folding beds, bunk beds, twin beds, powered bunks, convertible sofa/beds, and Murphy beds that conveniently raise or stow-away for added living space when not in use.

Beds are only to be used while the motorhome is stationary. While traveling, always ensure passengers remain seated and properly secured with safety belts.

Described in this section are instructions pertaining to beds, their safe use, and operation. If you have any questions regarding the beds or furniture installed in your motorhome, please contact TMC's Customer Care.

## Schwintek™ Powered Over-cab Bunks

TMC Class A motorhomes may be equipped with LCI's Schwintek Over-Cab Bunk System, which utilizes a lift mechanism based on motors and gear tracks, similar to a motorized slideout system. This motorized system raises and lowers the bunk into position and may feature multiplex integrated controls.



**IMPORTANT! Ensure powered over-cab bunks are in their full lowered position, resting on the lower stops before use. Otherwise, damage to the gear tracks and motors could occur.**



(Above) Powered Over-cab Bunk in the Raised position. (Below) Powered Over-cab Bunk in the lowered position.



To lower the powered over-cab bunk:

1. Level and/or stabilize the motorhome with the on-board hydraulic leveling system or electric stabilizers.
2. Turn the chassis engine OFF.
3. Ensure the Parking Brake is ENGAGED.
4. Turn ON the master battery switch.

NOTE: If the auxiliary battery(ies) are low, it may be necessary to connect to shore power or operate the generator to ensure sufficient 12-volt power to operate the powered over-cab bunk system.

5. If the motorhome is equipped with windshield and cab side window privacy shades (powered or manual), pull down or install the shades before lowering the bunk.
6. Remove the safety pins, both left and right side (Figure 1).
7. Fully recline the driver's and passenger's seat backs (Figure 2).



Figure 1. Remove both left and right-side travel safety pins.



Figure 2. Recline both front seat backs before lowering the powered over-cab bunk.

8. On the Multiplex Slides/Awnings Menu screen, PRESS AND HOLD the operating switch to lower the over-cab bunk. Hold the switch until the bunk is completely lowered, and continue to hold the switch for a few additional seconds. This operation helps to keep the operating motors synchronized (Figure 3).
9. Locate and extend bunk ladder, then securely place ladder hooks into ladder brackets on the front rail of the bunk.

To raise the powered over-cab bunk:

1. Remove all non-bedding items from the bunk before raising. Ensure bedding remains well away from gear tracks.
2. Raise over-cab bunk until it stops; continue to hold the control switch for 3 additional seconds.
3. Install the travel lock pins.
4. Lower the powered over-cab bunk down onto travel lock pins; continue to hold the control switch for an additional 3 seconds. This operation helps keep the motors synchronized.
5. Return the front seats backs to their full up-right position.

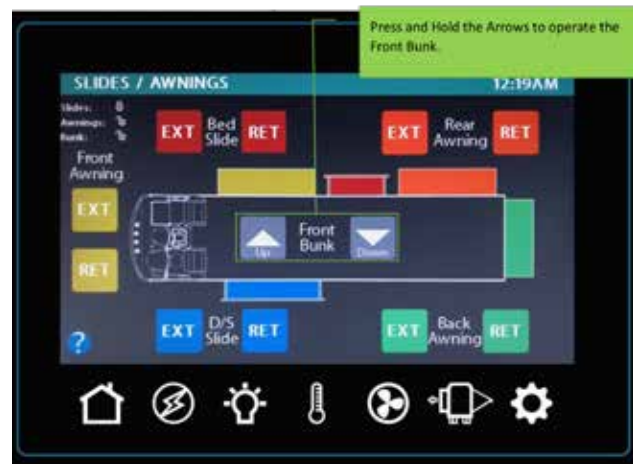

Figure 3. With multiplex systems, the powered over-cab bunk operating controls are usually located on the Slides/Awnings Menu. Some multiplex systems will also include bunk controls on a convenient wall switch.

Motorhomes may be equipped with an over-cab bunk operating switch panel similar to this illustration. Use a key to activate the control, then press and hold the rocker switch to either raise or lower the powered bunk. The key lock prevents unintended bunk operation.



## NOTES:

- Powered over-cab bunks are usually equipped with an ignition lock-out that prevents the operation of the bunk while the vehicle's engine is running.
- If your motorhome is equipped with a multiplex control system, controls for the powered over-cab bunk are incorporated into the main touchscreen panel; usually on the Slides/Awnings menu screen.
- If your motorhome is not equipped with a multiplex control system, operation of the powered over-cab bunk is located on a separate switch panel, which includes a safety lock-out device, preventing unintended operation of the bunk.
- Powered bunks operate via the 12-volt electrical system and require fully-charged auxiliary battery(ies). If the auxiliary battery(ies) are not fully charged, plug into shore power or operate the generator to ensure adequate operating power for the power bunk.
- Powered over-cab bunks usually consist of an operating system of motors and gear tracks similar to electric slideouts. As with slideout operation, holding the operating switch until the bunk is either fully lowered or raised helps keep the motors in-sync. Avoid stopping mid-travel; motors have a tendency of becoming unsynchronized, which causes binding and prevents proper operation.

## EuroLoft™ Over-Cab Bunks

**⚠ WARNING**

- **Failure to follow the operational instructions contained in this manual and the manufacturer's manual may result in death, serious injury, or property damage.**
- **Follow all safety instructions stated in the previous section regarding powered over-cab bed lift systems.**
- **Always make sure that the Euroloft bed lift path is clear of people, pets, and objects before and during operation. Always keep away from the slide rails when the bed is being operated.**
- **The bed lifting system must NEVER be operated while the vehicle is in motion.**
- **The over-cab bunk must NEVER be occupied while the vehicle is in motion.**
- **DO NOT operate the vehicle with the bed in the down or partially down position.**
- **DO NOT use the powered over-cab bed for storage**

**⚠ CAUTION**

- **DO NOT tamper with or disable any safety device of this bed lift system.**
- **NEVER exceed the maximum weight capacity of this bed system.**
- **DO NOT allow people or pets on the bed while it is being operated up or down.**
- **DO NOT allow children to hang on the bed rail while the bed is being operated up or down.**
- **DO NOT interfere with the bed lifting system while operated, either with any objects or with hands.**
- **Before starting and operating the vehicle, always make sure the bed lift system is in its highest position and travel safety pins, belts, or other securing apparatus is properly utilized.**
- **DO NOT allow children to operate the bed lift system without adult supervision.**
- **NEVER operate the bed lift system while people or pets are on top or underneath the bed.**
- **If the bed fails to raise, DO NOT operate the vehicle with the bed in the down position. The manufacturer has provided a method of raising the bed manually using a crank.**

TMC Class A motorhomes may be equipped with LCI's Euroloft Over-Cab Bunk Lift system, which utilizes a motorized lift mechanism based on coiling and uncoiling very strong and secure nylon straps. This motorized system quickly raises and lowers the bunk into position and features a nearly silent operating action.

Prior to operating the Euroloft bed lift system:

1. The vehicle must be parked, secured, and stabilized before starting the bed lift operations.
2. Be sure children and pets are well away from moving parts of the bed lift system. NOTE: The bed descends rather rapidly, so ensure no-one is underneath the bed prior to operation.
3. Clear away any potential obstructions from underneath the bed before operating.
4. **ALWAYS** recline the front driver and front passenger seat backs before lowering the over-cab bunk.



Reclining front seats (Class A).



EuroLoft over-cab bunk in the up or stowed position (above). EuroLoft bunk in the lowered position (below).



To lower the Euroloft over-cab bunk:

1. If installed, remove safety belts travel pins or other securement devices.
2. The motor of the bed lift system operates on 12-volts DC. Turn ON the Master Battery Switch.
3. Locate the Euroloft control panel and insert the key in the safety switch; turn the key to the ON or UNLOCK position.



4. PRESS and HOLD the arrow-shaped DOWN Position switch. A green LED light on the control panel will turn ON in the direction of bed is moving. The bed will stop automatically when it reaches the preset stop position.



5. Release the DOWN button when the bed stops moving.
6. Turn the safety key to the OFF or LOCK position.
7. Locate the telescoping bunk ladder. Usually stowed in a rear bedroom closet.
8. Extend the ladder (see ladder instructions).
9. Insert the ladder hooks into the front rail brackets.

*NOTE: The bed will stop moving when the UP or DOWN switches are released. Be sure to fully lower the bed for use and fully raise the bed to stow before travel.*

To raise the Euroloft over-cab bunk:

1. Ensure all items (pillows, clothing, travel cases, children, and pets) are removed from the over-cab bunk. Blankets can remain, as long as they do not become entangled in the bed lift mechanism.
2. Remove and stow the telescoping ladder.
3. While ensuring children and pets stay away from moving parts. Turn the keyed safety switch to the ON or UNLOCK position.
4. PRESS and HOLD the UP arrow switch. A green LED will light in the upward direction. Continue to hold the UP switch until the bed is in its fully upward and in its stowed position.
5. Release the UP switch and turn OFF or LOCK the keyed safety switch.
6. Attach any installed securement devices (belts or pins) in preparation for travel.
7. Return the front driver's and front passenger's seat backs to their upright position.

**Manual override:**

If the electric lift mechanism fails to operate, first check:

- Is the Master Battery in the ON position?
- Is the safety key inserted and in the ON or UNLOCKED position?
- Is the auxiliary battery fully charged? If not, connect to shore power or operate the generator to ensure full 12-volt system power.
- Is there a fuse blown in the electrical panel?

If after checking these electrical-related items and you still cannot operate the lift system, there is a provision to raise and lower the bed manually.

1. Locate and remove the access panel located toward the left rear and underside of the bed (Fig 1).
2. Locate the crank motor socket, along the lower portion of the drive motor (Fig 2).
3. Insert the supplied crank into the motor socket (Fig.3).
4. Turn the crank **CLOCKWISE** to raise the bed.
5. Turn the crank **COUNTER-CLOCKWISE** to lower the bed.
6. Have the bed lift serviced by an OEM-authorized dealer or service center as soon as possible. Do not operate the bed lift on a continued basis until service is complete. If not, the bed lift mechanism could become further damaged.

**Maintenance:**

The Euroloft bed lift system has been designed to require very little maintenance. To ensure a long operational life of the system, follow these procedures:

- When the bed is raised, visually inspect the slide rail assemblies. Check for excess buildup of dirt or other foreign material. Remove any debris that may be present.
- If the system squeaks or makes any unusual noises, blow out any debris from the drive shaft and apply a dry lubricant to prevent and/or stop squeaking.



Figure 1. Motor Access Panel.



Figure 2. Motor Drive Socket.



Figure 3. Insert Crank. Turn clockwise to raise, counter-clockwise to lower the bed.

## Electric Bed Lift Systems: Garage Area

**⚠ WARNING****BEDS ARE NOT TO BE OCCUPIED DURING TRAVEL**

- The sleeping accommodations in this vehicle are designed for occupancy only while the vehicle is NOT in motion.
- All occupants in this vehicle must be seated at a designated seating position and must always wear seatbelts while this vehicle is in motion. Failure to do so can result in death or severe injury.
- Ensure there are no fuel, fuel containers, or other flammable liquids or materials in the garage area if it is to be used as a sleeping area. Breathing fumes is harmful and fumes present a fire hazard.
- Before operating any motorized bed system, ensure children and pets are well away from moving mechanisms.
- Stay clear of moving parts, which can pinch, crush, or cut.
- Do not allow children to ride or play on beds when beds are in motion.
- Do not raise beds when occupied with adults, children, or pets.
- Do not use raised bed as a storage area.
- Elevated beds present a fall hazard, which may result in injury. Use of safety nets is recommended for children using elevated beds.
- When the bed is in the raised position, always use safety lock pins to prevent beds from unintended lowering.

**⚠ CAUTION****BEFORE OPERATING ELECTRIC BED:**

- Remove safety lock pins before attempting to lower bed.
- Lower bed completely before use.
- Drop-down beds have weight limits; never exceed the weight limit of the power drop-down bunk. Failure to comply with load capacity limits could cause bed failure, which could result in injury.
- The rear garage powered bed must be stowed and properly secured in the UP or raised position prior to and during travel.

**⚠ CAUTION****XXX LBS. MAX LOAD CAPACITY FOR THIS BED**

- Failure to comply with the load capacity could cause bed failure which can result in injury.
- Elevated beds can present a fall hazard which may result in injury.
- Do not allow adults, children, or pets on drop-down beds or bunks while the lift mechanism is in operation.
- **BEDS ARE NOT TO BE OCCUPIED DURING TRAVEL.**

Select TMC motorhome models may be equipped with electric drop-down beds located in a rearward garage area. Do not exceed weight ratings for drop-down beds or bunks.

When equipped, drop-down beds provide this area with a convenient multi-purpose use; storage space for travel and sleeping accommodations when parked.

In addition, Class A Outlaw models feature powered over-cab drop-down bunks and Class C Outlaw models have a permanent over-cab bunk area.

The typical load rating of the bed is 500 pounds in the stationary (lowered) position, however, follow all weight restriction labels installed on or near bed lifts.

*NOTE: All drop-down beds have a maximum weight rating. Never overload the bed. The garage bed lift system is a chain-driven two trolley mechanism operated by a 12-volt DC motor.*

## Operating precautions:

- **ALWAYS** raise the bed(s) to the full up position before travel to avoid damage to the bed lift system.
- **ALWAYS** make sure the safety lock pins are securely fastened to all four corners of the bed platform before traveling.
- **ALWAYS** make sure that the areas above, below, and adjacent to the bed(s) are free from obstructions before operating the bed.
- **ALWAYS** check before operating bed to ensure that there is nothing interfering with the travel of the chain mechanism inside the c-channel.
- **ALWAYS** use care when loading cargo or vehicles in the garage area to avoid damage to the bed mechanism.
- **ALWAYS** properly secure loads in the garage area to avoid damage to the bed mechanism from shifting or falling loads.

- **NEVER** operate the bed with any items other than bedding on the bed platform.
- **NEVER** travel with any items other than bedding on the bed. Loose items can become projectiles.
- **NEVER** operate the bed with people or pets are on the bed platform.
- **NEVER** hang items from the bed frame or hang more than 20 pounds of weight on the cross-connecting shaft.

To lower the garage drop-down bed:

1. Ensure children, pets, and obstacles are well clear of the path of the moving bed.
2. Turn ON the master battery switch, or plug into shore power, or operate the generator.
3. Locate the bed operating switch. In some installations the bed operating control may be integrated within the multiplex touchpad controller. Other installations, the switch is located on a separate bed-lift switch panel.
4. Remove travel lock pins (4). To facilitate pin removal, slightly raise the bed, which releases tension from the pins.
5. Lower the bed to its sleeping position.

To raise the garage drop-down bed:

1. Ensure children, pets, and obstacles are well clear of the path of the moving bed.
2. Locate the bed operating switch. In some installations the bed operating control may be integrated within the multiplex touchpad controller. Other installations, the switch is located on a separate bed-lift switch panel.
3. Activate the switch to raise the bed.
4. Insert safety lock pins, usually one in each corner of the bed lift mechanism.

*NOTE: Powered bunks operate via the 12-volt electrical system and require fully-charged auxiliary battery(ies). If the auxiliary battery(ies) are not fully charged, plug into shore power or operate the generator to ensure adequate operating power for the power bunk.*



Drop-down bunk available in Class A (above) and Class C (below).



Typical safety lock pin



Typical Bed-lift switch panel. Styles may vary.

## Class C Cab-over Bunks

### **CAUTION**

Risk of injury due to falls exist with all raised beds, bunks, and ladder use.

- **NEVER** occupy a cab-over bunk when the vehicle is in motion.
- **NEVER** exceed weight restrictions of a cab-over bunk area.
- **Always** use an appropriate ladder to access the bunk area.
- **Use safety netting when children occupy cab-over bunk areas.** Most Class C models include a roomy bunk area above the cab. When used safely, the cab-over bunk provides a convenient and out-of-the-way sleeping and lounging area. Over-cab bunks have weight limitations, which are posted on a safety label prominently affixed near the bunk access.



**IMPORTANT!** Always follow safe practices when using cab-over bunk areas, especially when occupied by children.

## Bed Safety Systems

### **WARNING**

Ensure that installed safety nets or bed rails do not interfere with an emergency evacuation of the motorhome.

### **NOTICE**

Ensure that an installed elevated bed safety system does not interfere with the operation of motorized bed lift systems.



Typical over-cab bunk safety net. Optional or dealer-installed.

Bed safety systems are not typically provided by TMC, however they may be standard or optional equipment for your motorhome brand and floor plan. You, the motorhome owner, should determine if a bed rail or safety net system is necessary and based on your intended uses, the age of the occupants, and their risk of injury. There are numerous bed safety system designs available. Your dealer should be able to assist you with selecting and installing suitable bed safety systems.

When installing a bed safety system, follow the manufacturer's installation instructions carefully, ensuring anchors are securely affixed to structural components. Take in to account the size and height of the mattress (either originally installed or a replacement) so that the safety system is the appropriate height above the top of the mattress. Make sure the bed safety system allows for rapid occupant egress in the event of an emergency.

## Tips For Safe Elevated Bed Use

- Motorized cab-over bed lift systems must **ALWAYS** be in the **FULLY UP POSITION** while the vehicle is in motion.
- Please use sound judgment when allowing children to sleep in any style of elevated bed. Generally, it is not advisable for children to sleep or occupy an elevated bed or bed loft area without adequate fall protection.
- Discuss proper usage of any elevated bed/electric bed lift system with your children and make sure they are supervised if playing in the bedroom/sleeping area of the motorhome with elevated beds. **DO NOT** allow horseplay on or under the elevated beds and **DO NOT** hang items such as hooks, belts, jump ropes, or towels from any part of an elevated bed.
- Always follow the weight restrictions posted on the warning label near elevated beds.
- **DO NOT** allow children to operate powered bed lift systems (if equipped). Lowering and raising of powered beds should only be done by an adult.
- No person or pet should be on powered beds when being lowered or raised.

If you have any questions about elevated beds, powered bed lift systems, or bed safety systems, please contact TMC Customer Care:

877-855-2867

## Mid-ship Bunk Beds

### **⚠ CAUTION**

**Risk of injury due to falls exist with all raised beds, bunks, and ladder use.**

- **NEVER** occupy a bed or bunk when the vehicle is in motion.
- **NEVER** exceed weight restrictions of a raised bunk or bed.
- **Always** use an appropriate ladder to access the bunk area, ensuring the ladder rungs are locked and the ladder securely hooks into the fascia brackets before use.
- **Observe** ladder weight restrictions and do not use ladders for purposes that they are not designed or intended for.
- **The use of safety netting is recommended whenever small children occupy raised beds or bunks.**
- **When converting a bunk area into a closet or wardrobe, ensure the raised bunk platform is securely latched in its up or folded position, thus avoiding potential injury or property damage due to a falling bunk.**



Mid-ship Over/Under bunk beds

Several TMC floor plans feature mid-ship bunk beds. Without taking up much floor space, mid-ship bunk beds provide additional sleeping capacity for larger families and traveling groups.

Bunk areas may be equipped with entertainment devices, such as TV's or tablet holders. Convenient charging ports and electrical outlets are also typically installed in bunk areas. Bunk areas may also be designed to convert to a large closet or wardrobe. This is usually accomplished by the upper bunk being hinged. When raised and secured in its upward position, this area easily transforms into a large hanging clothes wardrobe. A convenient clothes rod is installed for this purpose.

*NOTE: When converting the bunk into a clothes wardrobe, be sure the bunk is securely latched so that it stays in position.*

### Converting Bunk to Wardrobe:

1. Remove upper mattress (Fig. 1).
2. Rotate bunk platform to vertical position (Fig. 2).
3. Latch bunk (Fig. 3).
4. Lower cloths bar by grasping and pushing against spring mechanism while rotating downward (Fig. 4).



Fig. 2



Fig. 1



Fig. 3



Fig. 4

## Telescoping Bunk Access Ladders

### **⚠ CAUTION**

**Only use ladder for its intended purpose as an aid to access over-cab bunks or other raised sleeping areas. Observe all weight restrictions of the telescoping ladder and ensure rungs are locked and secure before use.**

**Before climbing the ladder, ensure ladder clips are fully engaged into the ladder securing brackets located on the face of the bunk. Improper use and abuse of the ladder could lead to severe injuries.**

TMC Class A and Class C motorhomes may be equipped with a telescoping ladder that is designed specifically to be used to access over-cab or other elevated bunk areas. The ladder easily expands for use and collapses for compact storage.

Ladders are supplied in a variety of lengths and rungs, appropriate for use with the motorhome's brand and floor plan application.

#### Expanding the ladder:

1. While holding the collapsed ladder in an upright position and ensuring your balance, place one foot on the lower rung.
2. Grasp the upper rung and pull upward until the ladder is fully extended.
3. Ensure the locking tabs on each rung fully engage.



Telescoping Bunk Ladder, shown stowed and ready for use.

4. Engage the clips located on the top rung into the ladder brackets located on the face of the bunk.
5. Carefully climb the ladder to gain access to the bunk area.

#### Collapsing the ladder:

1. Lift the ladder, disengaging it from the securing brackets located on the face of the bunk.
2. Starting with the top rung, disengage the locking tabs by sliding the tab towards the center of the rung. When you hear a clicking sound, the tab will stay in an unlocked position. Repeat for the tab on the other side of the rung.
3. With the rung tabs unlocked, collapse the ladder tubes into the next lower section.
4. Repeat until all ladder sections are collapsed.
5. Stow the ladder.



To Unlock: slide tabs towards the center of the rung. When a 'click' is heard, tab will lock OPEN, allowing section to collapse.

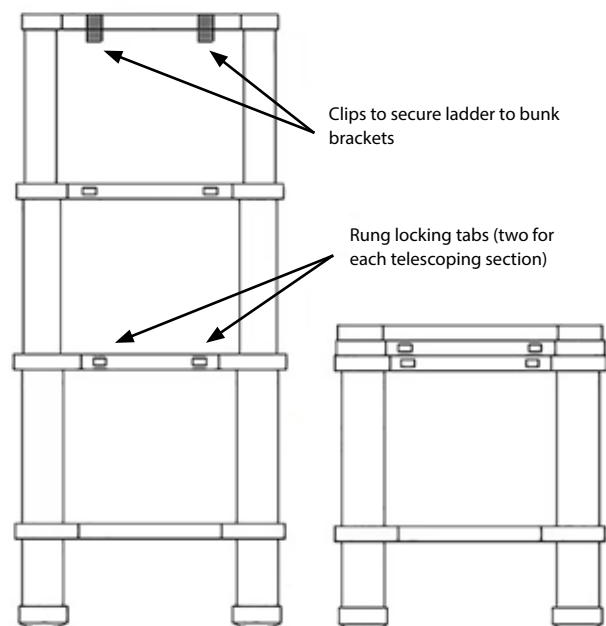

## Theater Seating

### **⚠ WARNING**

- **All occupants in this vehicle must be seated at a designated seating position and must always wear seatbelts while this vehicle is in motion.**
- **All swivel and/or reclining seats must be returned to their upright and locked position while the vehicle is in motion.**
- **Seatbelts are designed for single occupancy. DO NOT use a seat belt for more than one person at a time.**

**Failure to do so can result in death or severe injury.**

Many TMC Class A and Class C motorhomes offer optional two-position theater seating. Theater seating provides either upright or reclined seating for comfortable relaxing inside TMC motorhomes. Theater seating includes seatbelts for passenger safety while traveling, cup holders and a storage bin for stowing television and other entertainment remote controls or devices.

For additional convenience and comfort, theater seating on select TMC Motorhomes feature powered recline. Premium packages add heated seating and massage functions.

### NOTES:

- When optional, theater seating usually replaces a standard jack-knife or tri-fold sofa, therefore available sleeping and passenger seat belt positions are reduced.
- Powered seating functions operate on 120 volts AC, therefore the motorhome must either be connected to shore power or operating on generator power to use these features.



Theater Seating include powered recline, heat, and massage, along with USB charging ports. Style and upholstery are dependent upon floor plan and interior decor options.

## Special Seating Controls and Features

### **⚠ WARNING**

- **All occupants in this vehicle must be seated at a designated seating position and must always wear seatbelts while this vehicle is in motion.**
- **All swivel and/or reclining seats must be returned to their upright and locked position while the vehicle is in motion.**
- **Seatbelts are designed for single occupancy. DO NOT use a seat belt for more than one person at a time.**

**Failure to do so can result in death or severe injury.**

Powered theater seating installed in select TMC Class A Diesel motorhomes feature a safety lock-out function that prevents seat reclining. For safety reasons, it is important to use this lock-out function whenever the motorhome is in motion and passengers

occupy the theater seating or anytime it is advisable to place the seating in a full, upright position and keep it there.

*NOTE: This lock-out function is only available with theater seating that has a control panel surrounding the armrest cup holder (see illustration below).*

#### Locking the Theater Seats

To lock-out the theater seating, **PRESS** and **HOLD** the RECLINE and INCLINE buttons simultaneously for 7 seconds. Doing so will lock out the recline/incline motor drive assembly.

#### Unlocking the Theater Seats

To unlock the theater seating, **PRESS** and **HOLD** the RECLINE and INCLINE buttons simultaneously for 3 seconds. This restores normal functionality to the control panel and drive motors.



Select theater seating features a safety lock-out function that is accessed by the seating control panel.



## Sofa Bed Conversions

### **⚠ CAUTION**

**Sofa beds contain hinged panels and brackets which present pinch points. Keep fingers and other body parts away from hinged panels and brackets.**

### Jack-knife Sofa

To convert a jack-knife sofa into a bed:

1. If the sofa is installed along a slideout wall, extend the slideout.
2. Lift the front edge of the bottom cushion to approximately 45 degrees and pull towards you (Figure 1).
3. With the pulling motion, the back of the sofa should begin to recline. Push the back down while continuing to pull the bottom towards you (Figure 2).
4. When the back cushion is horizontal, lower the bottom cushion to lay flat (Figure 3).

To return the bed to a sofa:

1. Lift the leading edge of the bottom cushion to approximately 45 degrees (Figure 4).
2. Push the leading edge of the bottom cushion in a downward and backward direction. This will lift the back cushion. Pull the back towards you while continuing to push the bottom cushion downward and backward (Figure 5).



Jack-Knife Sofa Bed

3. When the back cushion is in its up-right position, lower the bottom cushion to its seating position (Figure 6).

*NOTE: Sofas are usually fitted with safety belts, which may fall into the sofa base during bed conversion. When converting the bed back to a sofa, be sure to feed the safety belts through the space between the bottom cushion and back panel so that the safety belts are available for passenger use.*



Figure 1



Figure 2



Figure 3



Figure 4



Figure 5



Figure 6

## Tri-Fold Sofa

To convert a Tri-fold sofa into a bed:

1. If the sofa is installed along a slideout wall, extend the slideout to ensure adequate floorspace for the bed.
2. Remove the back cushions and set aside (Figure 1).
3. Grasp and lift the front edge of the bottom cushion (Figure 2) and rotate to approximately 90 degrees (Figure 3).
4. While holding the seat in position, flip and lock both folding legs (Figure 4).
5. With a firm grasp of the bottom of the sofa, lift and pull towards you (Figure 5).
6. Continue to lift and pull out the seat cushion panel until the seat panel and center panel are fully extended and lower to the floor (Figure 6).
7. Grasp the back panel and lower to its horizontal position (Figures 7 and 8).
8. Place the back cushions against the outside wall (Figure 9).



Tri-fold Sofa Bed

To return the Tri-fold bed to a sofa:

1. Rotate the back panel to its vertical position.
2. Lift the outside edge of the seat panel upward while folding the middle panel into its stowed position.
3. Fold the flip-out legs to their stowed position along the bottom of the seat panel.
4. Lower the seat panel to its seating position.
5. Return the back cushions to their seating position.



Figure 1



Figure 2



Figure 3



Figure 4



Figure 5



Figure 6



Figure 7



Figure 8



Figure 9

## Murphy Beds

Several TMC motorhome floor plans are equipped with space-saving Murphy beds. These beds simply fold-down from their up-right and stowed position for comfortable bed-time use. When more floor space is needed or when prepping the motorhome for departure, Murphy beds are easily returned to their up-right and stowed position.

### Manual Murphy Bed, lowering the bed:

1. Remove back cushions and place to the side (Figure 1).
2. Pull up and raise the foot bar, ensuring it locks into its fully extended position (Figure 2).
3. Pull down on the release latch located along the upper right corner of the bed mechanism (Figure 3).
4. Carefully rotate and lower the bed to its horizontal position (Figures 4 and 5).
5. Be sure the foot bar is in its fully vertical and locked position when the bed is in its fully horizontal position (Figure 6).

### Raising the bed:

1. Lift the outer edge of the bed to a near vertical position.
2. Rotate the foot bar down and towards the bottom of the bed.
3. Continue to push and rotate the bottom of the bed to its full up-right position, ensuring the latch located along the right-side and upper edge engages, securing the bed.
4. Replace the back cushions.



Manual Murphy Bed



Figure 1



Figure 2



Figure 3



Figure 4



Figure 5



Figure 6

## Powered Murphy Bed, lowering the bed:

1. Remove the back cushions and place to the side (Fig 1).
2. Locate the power switch. Turning the key to the right (clockwise) unlocks the control pad (Fig. 2).
3. Press and hold the DOWN switch and lower the bed to approximately 45 degrees (Fig 3).
4. Grasp the folded foot bar and rotate approximately 270 degrees (Fig 4).
5. Pull the locking pin to release the lower portion of the foot bar and rotate to its extended position.



Figure 1



Figure 2, 3



Powered Murphy Bed; stowed (above) and lowered position (below)

Be sure the locking mechanism secures the lower foot bar in the lowered position (Fig 5).



Figure 4

6. Press and hold the DOWN switch until the bed is in its full horizontal position.



Figure 5

Be sure the foot bar remains in its fully vertical position (Fig 6).



Figure 6

## Raising the bed:

1. Press and hold the UP switch and raise the bed to approximately 45 degrees.
2. Pull the locking mechanism to release the lower foot bar and rotate to its folded position.
3. Rotate the folded foot bar to its stowed position, on top of the bed mattress (Fig 7).
4. Continue to press and hold the UP switch until the bed is fully vertical.
5. Turn the switch key to the left (counter-clockwise) to secure the control pad.
6. Replace the back cushions.



Figure 7

## Rear Bed with Cargo Storage Conversion

Select TMC motorhomes are equipped with a rear door that allows access to a large interior cargo area when the bed is secured in an upright position. Always follow safety warnings regarding suitable cargo types, load weight, and cargo securing when using this space for cargo storage and transportation.

To lift and stow the bed:

1. Remove bedding, pillows, and other items from the bed and mattress and close the bedroom window. Items left on the bed may hinder the latching of the bed in its upright position (Fig. 1).
2. From the inside, firmly grasp the bed frame along the front and side opposite the outside edge and lift upwards (Fig. 2).  
NOTE: The outside edge of the bed frame is hinged and affixed to the motorhome. Also, a gas-strut is affixed to the rear of the bed frame, which aids in the lifting of the bed.
3. Continue to lift the bed to its vertical position. It may be necessary to tuck the edges of the mattress to clear corner trim and the latch bracket (Fig. 3).
4. While steadying the bed in its upright position, click the securing pin into the latch bracket (Fig. 4).



Figure 1



Figure 2



Figure 3



Figure 4

To lower the bed:

1. Remove all items and cargo from this storage area.
2. While facing the bed frame, grasp and steady the bed with your right hand, while releasing the latch pin with your left.
3. Gently lower the bed to its horizontal position, being careful to step towards the front of the motorhome to avoid being pinched between the bed frame and the interior wall.
4. Once the bed is completely lowered, bedding and pillows can be placed on the bed mattress.

## Powered Rear Bed with Cargo Storage Conversion

### **⚠ WARNING**

- **Failure to follow the operational instructions contained in this manual and the manufacturer's manual may result in death, serious injury, or property damage.**
- **Follow all safety instructions stated in the previous section regarding powered over-cab bed lift systems.**
- **Always make sure that the powered bed lift path is clear of people, pets, and objects before and during operation. Always keep away from the slide rails and lift mechanism when the bed is being operated.**
- **The bed lifting system must NEVER be operated while the vehicle is in motion.**
- **The bed must NEVER be occupied while the vehicle is in motion.**

### **⚠ CAUTION**

- **DO NOT tamper with or disable any safety device of this bed lift system.**
- **NEVER exceed the maximum weight capacity of this bed system.**
- **DO NOT operate the bed lift system while people or pets are on top or underneath the bed.**
- **DO NOT allow children to hang on the bed rail while the bed is being operated up or down.**
- **DO NOT interfere with the bed lifting system while operated, either with any objects or with hands.**
- **DO NOT allow children to operate the bed lift system without adult supervision.**

Select TMC motorhomes are equipped with a rear queen-sized bed that is motorized to lift to the ceiling, creating a large cargo area in the rear of the motorhome. Exterior doors allow cargo access from the outside. The bed can be positioned in a full-up, full-down, or any position in-between. This feature allows for varying volumes of storage, while keeping the bed in a usable position. Always follow safety warnings regarding suitable cargo types, load weight, and cargo securing when using this space for cargo storage and transportation.

To LOWER the bed:

1. Ensure cargo and other items are removed from the cargo area.
2. Turn ON main battery switch.
3. Locate the powered bed control panel and turn the lock key to the unlocked position.



Figure 1: Lower bed by pressing DOWN arrow on the control panel.

4. Press the DOWN switch and hold until the bed is either fully lowered or in the desired lowered position, allowing for under-bed storage (Figure 1).
5. Turn the key on the powered bed control panel to the locked position.
6. If needed, install the bunk ladder, ensuring that the ladder rungs are properly extended and locked and the ladder tabs are fully engaged in the ladder holding brackets.
7. Once the bed is completely lowered, bedding and pillows can be placed on the bed mattress.

To RAISE the bed:

1. Remove all contents from the top of the bed, including pillows.
2. Remove, collapse, and stow the access ladder.
3. Turn ON the main battery switch.
4. Locate the powered bed control panel and turn the key to the unlocked position.
5. Press the UP button until the bed is fully raised or at the desired raised position.
6. Turn the key on the powered bed control panel to the locked position.



With bed raised, a large cargo storage area of over 6 feet in height, including drawers and closet space is available.

## Dinette Bed Conversions

### **⚠ CAUTION**

**To avoid injuries, ensure tabletop is secured by its locking mechanism when it is in the up-right (dinette table) position.**

Most dinette seating areas are convertible to a sleeping berth. The tabletop is lowered from its normal position and becomes part of the bed foundation. Some tabletops are attached to brackets (Dream Dinette), which allows the tabletop to be easily lowered to the bed position, while other dinette designs require the removal of tabletop from support pedestal tubes, and manually placed into the lowered position.

Standard dinette bed conversion:

1. Remove the dinette seat and back cushions and set aside.
2. Lift the tabletop from its support pedestal(s).
3. Remove the support pedestal(s) from the floor bracket(s).
4. Place the tabletop between the dinette seats, ensuring the table edges are engaged in the seat channel.
5. Place the seat and back cushions on top and across the lowered table and dinette seats.

Dream Dinette® bed conversion:

1. Remove both back cushions (Figure 1).
2. From underneath the tabletop, rotate the locking lever approximately 180 degrees to its unlocked position (Figure 2).
3. Pressing equally and down on both long edges of the tabletop (Figure 3), lower the tabletop to its lowest position (Figure 4).
4. Place the seat and back cushions on top and across the lowered tabletop (Figure 5).

When returning the bed to the dinette configuration, be certain to lock the tabletop in the up-right position, with the lock-lever (Dream Dinette), or ensure the tabletop is securely fastened to the pedestal tube(s) and the pedestal tube(s) are secured into their floor bracket(s).

*NOTE: Dinette seating areas are usually fitted with safety belts. When converting the dinette back to normal seating, be sure safety belts are available for passenger use.*



Typical Dream Dinette



Figure 1



Figure 2



Figure 3



Figure 4



Figure 5

## Lagun® Table System

The versatile Lagun Table System is installed in several TMC Class B models. It provides convenient and adjustable work surface. The system consists of 4 main components:

- Mounting Bracket
- Table Leg
- Table Arm
- Table Mounting Plate

The Mounting Bracket is usually affixed to a vertical surface, such as on the forward side of the bench just to the rear of the driver's seat. The Table Leg slides onto the mounting bracket and is locked in place by turning a locking handle (clockwise to tighten, counter-clockwise to loosen). The upright leg has a slot on its reward side which allows for height adjustment.

The horizontal arm has tightening mechanisms on each end; one slips onto the pin on the top of the upright leg, while the other mechanism is used to receive a similar pin that is affixed to the table mounting plate in which the tabletop is mounted.

Once assembled, the locking mechanisms can be tightened to keep the table from moving, or the mechanisms can be loosened to allow the table to swing freely between seating positions.

Stowing the table and its components accomplished by loosening the locking mechanisms, then separating the components. The Table Leg stows onto slots built-into the table mounting plate, while the table arm is affixed to the pin on the table mounting plate. Turn the locking handles clockwise to secure the components.



**IMPORTANT! DO NOT SIT, KNEEL, OR STAND ON THE TABLETOP OR ITS COMPONENTS. The adjustable table, legs, and arm is designed to support up to 40 pounds of weight, including the weight of the tabletop. Damage to the table system can occur if weight loads exceed this amount.**



Lagun Adjustable tables.



Lagun Table System components stowed on the underneath side of the tabletop.

### Operating Tips:

- The Lagun Table Leg system can swivel, adjust vertically, or be disassembled for storage by loosening/tightening the handles.
- Loosen handles before connecting, disassembling, swiveling, or adjusting the table height.
- Tighten handles to secure into place.
- All handles tighten clockwise and untighten counter-clockwise. DO NOT overtighten handles as thread damage may occur, causing the handle to seize.
- Each handle has a mechanism that allows for a ratcheting-like movement. Therefore, tightening and loosening can be accomplished in spaces where handle movement is limited.
- Push the button on the handle center post IN while pulling outward on the handle, then spin the handle freely. Reposition the handle on its spline, then continue to tighten or untighten the locking mechanism.
- The vertical adjustment is approximately 6 inches up or down.
- When not in use, the table arm and leg can be stored on the bottom side of the tabletop.
- **Be aware of the limited height adjustment range. Tightening the leg handle when the leg is out of its adjustment range may cause damage to the leg track or the handle to become cross/threaded or seized.**

## Introduction

Select TMC motorhomes are equipped with Rapid Camp+ multiplex wiring systems. A multiplex system uses low-voltage, digital signals to control the electrical and electro-mechanical devices within the motorhome via an intuitive, user-friendly touchscreen control panel. Control functions vary from motorhome to motorhome, depending upon the available standard and optional equipment. However, in its typical configuration, a multiplex system will allow the user to monitor and operate these features from the main touchscreen panel:

- Lighting and fan controls
- Climate (HVAC) controls
- Holding tank and LP level monitoring
- Water heater, water pump, and heat pads on/off
- Electrical system monitoring; both AC and DC
- Battery energy monitoring
- Inverter settings and controls
- Generator on/off
- AGS (Automatic Generator Start) settings and controls
- PCS (Power Control System) settings and controls
- Slideout and awning control
- Shore Power Fault Indicator
- Solar Charging System
- Remote smartphone or tablet control via app



Typical multiplex main control panel. Features vary depending upon model and floor plan.

TMC installs multiplex systems supplied by two major vendors. Class A Diesel, most Class A Gas, Super C and select Class C models are equipped with versions of Firefly Integrations multiplex systems. While select Class A and C models receive multiplex systems supplied by BPro.



BPro Connect Touchscreen

Both manufacturers offer product manuals, helpful How-to guides, and videos from their websites.

If you have questions about your multiplex system, a few moments visiting these sites may give you the answer you need. Both manufacturers also provide technical support services, usually accessible by email, for more in depth help.

Although each motorhome model and floor plan will have its unique system design and features, in its standard form, the multiplex wiring system consists of:

- Centrally located multi-function touchscreen control panel
- Power management module (PPM)
- Individual wireless room switch panels

Careful attention has been designed into the system to make operation simple and user friendly. On the main touchscreen panel, the function of each control button is clearly displayed, appropriately sized, and logically placed. Conveniently located throughout the motorhome are individual wireless switch panels. Each control button on the wireless switch panels is evenly back-lit by LED illumination to provide feedback to the operator of the status of each function.

<https://www.fireflyintegrations.com>

<https://teambmpro.com>

**NOTE:** A multiplex wiring system is defined as an RV-C (a standardized communications protocol) network consisting of a main control panel with one or more remote switch panels. When a switch (or control function icon) is pressed, a signal is sent to a controller, which sends 12-volt power to a device to activate it. The RV-C network communicates with motorhome components and automates their function.

## Touchscreen Control Panels

There are several styles of touchscreen panels found in TMC motorhomes. Features found on touchscreen panels depend upon the features of a particular motorhome brand and/or floor plan. Although styling and features vary, all touchscreen panels are designed to be intuitive and easy to use.

Illustrated here are examples of typical touchscreen panels installed on TMC motorhomes. The user-interface may consist of an array of soft switches arranged across the bottom or around the perimeter of the panel, that act as menu access to control screens of the system. The individual menu screens provide a wealth of system controls and monitoring.

*NOTE: Some touchscreen panels are activated by pressing a function icon along the parameter of the panel, while others are activated by simply touching anywhere on the central area of the panel. Others yet, may have an ON/OFF switch located on the panel's parameter.*



Typical touchscreen panels; Firefly (above) and BMPPro (below). Features vary depending upon motorhome model and floor plan.



## Switch Panels

All Firefly multiplex systems installed on TMC motorhomes use SSP17 series wireless switch panels. Wireless switch panels are conveniently located throughout the motorhome to remotely control many of the functions found on the main touchscreen panel. Control functions vary from switch panel to switch panel. Some may control room lights and fans, while others may control awnings, water heaters, generators, bed lifts, or bed slides.

On the face of each switch panel are control icons that represent the function of the switch. Each control icon has a LED backlight to indicate whether the function is on or off. Depending on the control function, the switches may be momentary (press once for ON, press again for OFF), while other functions may require the user to press-and-hold for the function to operate correctly. Lights that are dimmable will have Up/Down arrows next to the icon. Press and hold these buttons to ramp the brightness up and down. Each time a button is pressed, the green operational LED will illuminate to indicate that the command has been sent to the system's controller.

The switch panels are easily removed from their mounting cradle, and because they are wireless, they can function as a remote control for the features indicated on the panel front plate. The panels are powered by a single coin-cell battery (#2032). If, when pressing a switch panel button, the green LED does not illuminate, the battery will need to be replaced (see note).

Check battery status for all wireless switch panels by clicking on the settings button on the multiplex main touchscreen panel, then navigating to the Wireless Switches screen.



Typical multiplex wireless switch panel. Battery compartment access (below).



*NOTE: To access the battery, pry the switch from the wall mounting cradle to expose the battery compartment on the rear of the switch and replace the #2032 coin-cell battery.*

## Main Electrical Control Boards

A multiplex wiring control system will include a main electrical panel. Some systems refer this panel as the master node or some other terminology. The main electrical panel is the power distribution center for the motorhome. The panel receives signals sent from the main touchscreen and remote switch panels and performs the actions that have been requested by activating and deactivating the required circuits.

The main panel will include low-voltage control connections to the individual electrical circuits that are controlled by the system. The main panel is then remotely connected to the user interface, or main touchscreen panel, where the user makes device control selections. In some multiplex systems, the connection from the main electrical panel to the user's touchscreen is by Bluetooth pairing, but it could also be a wired connection.

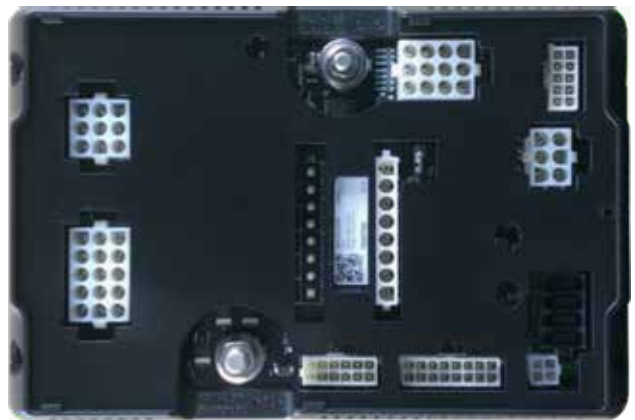

Firefly Integrations system control board



BMPro RVMaster Node main system control board

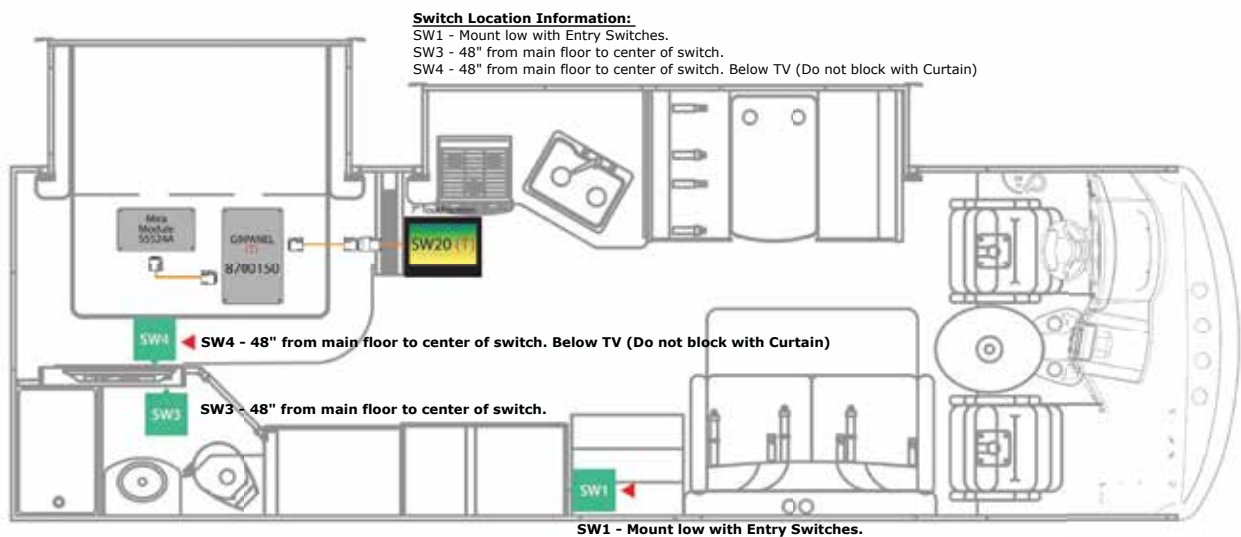

Wiring illustration (below) of a typical multiplex system; consisting of main touchscreen control panel, wireless room switches, and electrical power control panels and modules.

## Basic Multiplex Operation

### NOTICE

**Multiplex system manufacturers offer regular software and system updates, usually through an on-line link accessed through a Wi-Fi connection.**

**Contact TMC's Customer Care or refer to your multiplex system manufacturer's instruction manual for information pertaining to multiplex system updates.**

### NOTICE

**During very cold or very hot weather conditions, the image on touchscreen control panels (radio, multiplex, and other liquid crystal display (LCD) panels) may appear unclear or react slowly. Once the interior temperature of the motorhome stabilizes, normal LCD panel display and operations will resume.**

In this section are highlights of the multiplex systems currently installed in TMC Class A and Class C motorhomes. Multiplex systems, devices, and features depend upon brand and floor plan standards and options available.

Due to the variety of multiplex systems installed by TMC, it is not possible to include operational instructions in this manual. For detailed multiplex system instructions, please refer to the manufacturer's instructional manuals and other electrical systems information available in your owner's packet, the multiplex manufacturer's website, or through your TMC Owners Resource on-line document service. There, you will find documents and instructional videos covering important operational and safety information pertaining to the multiplex system installed in your motorhome.

[thormotorcoach.com/owners/](http://thormotorcoach.com/owners/)

Depending on the model and floor plan of the motorhome, it may be supplied with a multiplex control system sourced from a variety of manufacturers. However, regardless of the manufacturer, every multiplex system is designed to be intuitive to operate. Basic operation involves these steps:

1. Ensure DC power is ON to the motorhome; either from the auxiliary battery(ies) (by turning ON the master battery switch), or through a 120-volts AC source (shore power or generator, which provides DC to the motorhome via the converter or inverter).
2. With a power source activated, locate the main touchscreen panel. Some touchscreen panels will automatically 'turn on' or 'light up' when power is present, while other panels may require the user to press a button on the panel or touch the central display.

3. From the menu selections, navigate to the desired control feature. Some panels will have feature icons along one edge of the panel, while other systems will have feature icons displayed on the panel screen.
4. With the feature menu selected, simply operate the control for the desired effect. For example, turn on or off the lights, raise or lower the temperature, turn on or turn off the generator, operate slideouts, or operate awnings.
5. Return to the main menu by either pressing the HOME icon, or on some touchscreen panels, press a return arrow.

*NOTE: Some multiplex functions have ignition lockouts or other safety-related preconditions that prevent operation until it is safe to operate the function. If a function is locked out, a screen message will either indicate a problem exists or provide a reminder to perform a safety check before proceeding with control operations.*

## Remote Control

Most multiplex systems allow remote control via a smartphone or tablet app. Some systems are remotely-controlled via Bluetooth pairing, while other systems may connect remotely via a Wi-Fi signal. It is highly recommended that owners take advantage of this useful feature, for it gives the user operational control of the motorhome's features in the palm of the user's hand.

## Additional Multiplex Systems Information

Complete multiplex systems details and operational instructions are described in the manufacturer's owner's manuals and TMC's Multiplex Systems Guides available through your TMC Owners Resource on-line account:

[thormotorcoach.com/owners/](http://thormotorcoach.com/owners/)

Multiplex systems how-to videos are linked through your TMC Owners Resource account and are also available on TMC's YouTube site:

[www.youtube.com/user/ThorMotorCoach](http://www.youtube.com/user/ThorMotorCoach)

# Firefly Multiplex Systems

## Screen Navigation: Lyra

Select TMC Class A and Class C motorhomes equipped with Firefly Integrations multiplex systems may be supplied with one of two versions of touchscreen control panels. Touchscreens, such as the one illustrated below, feature main menu icon selections along the left side or lower edge of the screen.

Both touchscreen version allows for full multiplex system control by simply touching screen icons and selecting features.

Tap any icon from the navigation bar (left or bottom edge of the screen) to select the desired menu page. The currently selected page will always be listed in the top corner of the screen. Tap the HOME icon to return to the main screen.

*NOTE: Graphics and displayed features may vary, due to standard and optional features of the motorhome and software or hardware versions or upgrades to the multiplex system.*



- 1 **HOME:** Menu shows Master lighting control, TV Lift (if equipped), Fusion radio controls, Temperature settings (Heat and A/C), Holding tank monitors, Water pump and Water Heater controls, Battery Monitor, Solar charging menu access, Incoming AC and other electrical monitoring.
- 2 **LIGHTS:** Menu controls lighting for the entire motorhome; light circuits on, off, or dimmed. Any lighting circuit setting made on the Lights Menu are linked to and turned ON or OFF by the HOME Menu Light Master Switch.
- 3 **ELECTRICAL:** Menu displays incoming power (50A or 30A), of each power leg (voltage and current). Menu also contains generator Start/Stop controls and access to AGS and inverter settings.

- 4 **CLIMATE CONTROL:** Furnace and Air Conditioner(s) temperature settings.
- 5 **SLIDEOUTS AND AWNINGS:** Controls extending and retracting of slideouts and awnings. Gives warning if motorhome is not ready for slideout operation (parking brake, transmission, and other lockout features).
- 6 **FANS:** Control of kitchen, bath, and other ceiling mounted fans (covers up/down; speed).
- 7 **SETTINGS:** To reset the Touchscreen Panel (clock, F°/C°, Mobile App, network diagnostics, switch panel batteries, and more).

## Firefly Screen Navigation: Mini Gas

Tap any icon from the Home Screen, to select the desired Sub-Menu. The main battery switch must be ON to power and operate the multiplex touchscreen controller.

*NOTE: Graphics and displayed features may vary, due to standard and optional features of the motorhome and software or hardware versions or upgrades to the multiplex system.*



- 1 **HOME:** The Home Menu Screen is the main access area for all the multiplex system sub-menus. It also displays the front and rear air conditioner temperature settings, a clock, date, auxiliary battery condition, a shore power fault warning and access to a system search function.
- 2 **LIGHTING:** Menu controls lighting for the entire motorhome; light circuits on, off, or dimmed. Any lighting circuit setting made on the Lights Menu are linked to and turned ON or OFF by the Light Master Switch.
- 3 **ELECTRIC:** Menu displays auxiliary and chassis battery condition, Generator controls (prime, start, stop), AGS controls and settings, and Solar Charge Controller settings.
- 4 **CLIMATE:** Menu allows control of furnace and air conditioner (front and rear) temperature settings.
- 5 **FANS:** Menu allows control of kitchen, bath, and other ceiling mounted fans and covers (fan speed, covers up/down).
- 6 **COACH:** Menu allows control of slideouts and awnings. Also allows monitoring access to wireless switches installed within the motorhome. Gives warning if motorhome is not ready for slideout operation (parking brake, transmission, and other lockout features).
- 7 **TANKS:** Menu allows monitoring of water storage tank levels (fresh, gray, black), LP tank levels, water pump ON/OFF, and water heater ON/OFF.
- 8 **DIAGNOSTICS:** Menu and sub-menus allows the monitoring of all electrical circuits and indicates electrical faults.
- 9 **SETTINGS:** Menu and sub-menus allow for customization of display screens, connection to the multiplex mobile app, and other system features.

## Floor Plan Selection

If certain control features are not being displayed or functioning correctly on the Firefly touchscreen panel, the problem could be caused by:

- The incorrect floor plan may be selected (features and functions can be floor plan specific)
- A particular option for a floor plan may have been deactivated or inadvertently turned off in the Settings\Floor plan\Options screen.

### Checking Floor plan and Floor plan Options

1. On the SETTINGS Screen, locate the Floor plan section and verify that the correct floor plan (which matches the motorhome) is selected. If the indicated floor plan does not match the motorhome, proceed to step 2.
2. Press and hold the Floor plan box for 5 seconds to enter the Floor plan/Option selection screen. From here, select the correct floor plan and any options that are specific to the motorhome.
3. Typically, a list of available floor plans by TMC brand are listed. If necessary, select the matching floor plan for the motorhome.
4. Review the list of options for the motorhome. If an option that is installed on the motorhome is not checked or selected, select it on this screen.



Press and Hold Floor plan Box

5. Return to the control menus and locate the control buttons to the feature that was selected. The selected feature should now function as intended.

### EMS Override



Tap to enable EMS Override. Doing so will allow for manual control of HVAC in the event of a transfer switch failure. EMS Override will automatically become deselected upon power cycle.

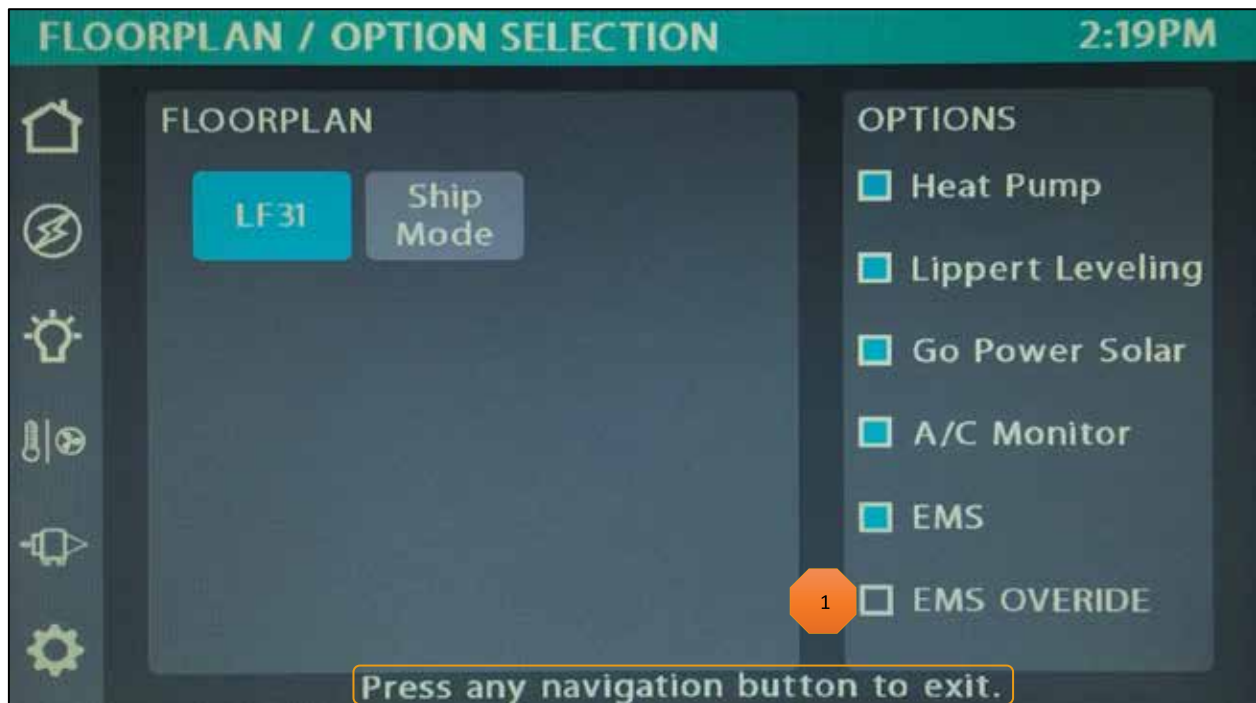

## Firefly Emprise Multiplex System

Installed in select Class C motorhomes, the Firefly Emprise System includes a 7-inch user interface touchscreen integrated with a multiplex distribution panel. This system enables users to monitor and control all 12-volt features and circuits of the motorhome.

The Emprise distribution panel is RV-C compatible and opens 180 degrees to allow access to the multiplex wiring connections. The system's low-profile touch-screen responds instantaneously to the user's touch and includes the option of remote control via a smartphone or tablet app.

*NOTE: Graphics and displayed features may vary, due to standard and optional features of the motorhome and software or hardware versions or upgrades to the multiplex system.*



Firefly Emprise  
Touchscreen and 12-  
volt distribution panel.

## Firefly Emprise Screen Navigation



- 1 **HOME:** The Home Menu Screen is the main access area for all the multiplex system sub-menus. It also displays the air conditioner temperature settings, a clock, date, auxiliary battery condition, a shore power fault warning and access to a system search function.
- 2 **LIGHTING:** Menu controls lighting for the entire motorhome; light circuits on, off, or dimmed. Any lighting circuit setting made on the Lights Menu are linked to and turned ON or OFF by the Light Master Switch.

- 3 **ELECTRIC:** Menu displays auxiliary and chassis battery condition and Solar Charge Controller settings.
- 4 **CLIMATE:** Menu allows control of furnace and air conditioner (front and rear) temperature settings.
- 5 **DIAGNOSTICS:** Menu and sub-menus allow the monitoring of all electrical circuits and indicates electrical faults.
- 6 **SETTINGS:** Menu and sub-menus allow for customization of display screens, connection to the multiplex mobile app, and other system features.
- 7 **WATER SYSTEM:** Soft switches allow control of the water pump (ON/OFF) and Holding Tank Heaters (ON/OFF).
- 8 **HOLDING TANK MONITOR:** The display gives a visual indication of the percent from empty to full in 1/3 increments of the holding tanks and LP tank. NOTE: Cassette toilet is not monitored.
- 9 **FANS AND LIGHT MASTER:** Soft switches allow control of the ceiling fan and lighting master (depending on the Lighting Menu selection).
- 10 **AWNING:** Soft switches allow for the extension and retraction of the camp-side awning. If installed, soft switches also control awning and exterior lighting.

## Firefly Phone App

Firefly Multiplex Systems can be remotely controlled via a smart-phone app. The system uses either an Eclipse or Mira Vegatouch wireless interface module. These modules easily connect to any Android or iOS device to give total control to many electrical, electronic, and mechanical systems installed in the motorhome. All it needs is to download the Eclipse or Mira Mobile App to your phone, then pair your phone to the interface module.

- **Vegatouch Mira:** The Mira interface allows remote control of motorhome functions from roughly a 90-foot radius of the motorhome.
- **Vegatouch Eclipse:** The Eclipse interface allows the same 90-foot radius control as the Mira, but also includes the option to access control functions from an Internet connection, therefore remote control can be accomplished virtually from anywhere.

*NOTE: If your Firefly Multiplex Touchscreen is displaying the wrong wireless remote module, press and hold the Vegatouch icon for 7 seconds. Doing so will switch between Mira and Eclipse modules.*

## Vegatouch Mira and Eclipse Setup

*NOTE: Make sure that Bluetooth is turned ON in your smartphone or tablet settings menu before proceeding with Vegatouch setup.*

1. **Locate the Login Information:** The Login information Screen (illustrated below) can be located from the Firefly SETTINGS MENU (Figure 1). Tap to enter the Vegatouchscreen.

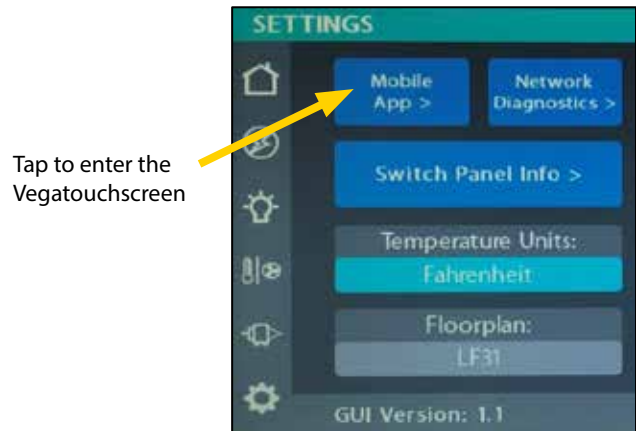

Figure 1

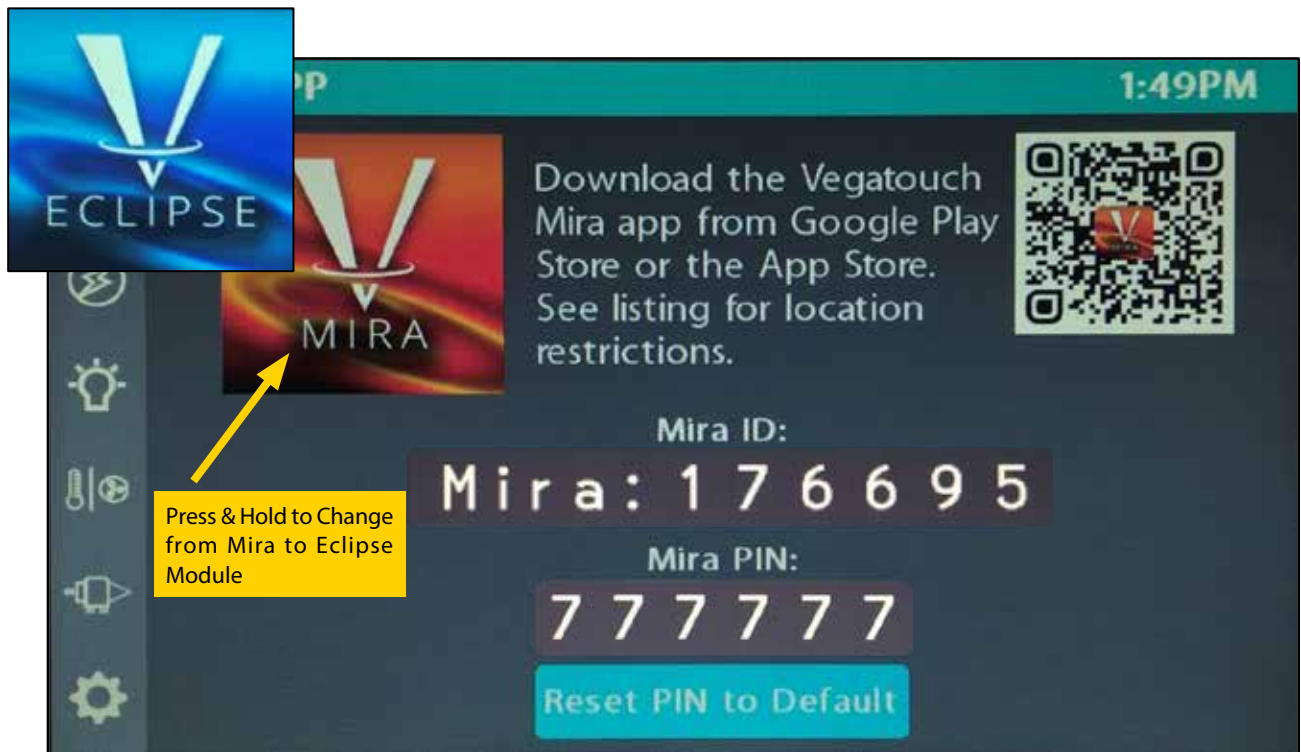

Illustration of the Mira or Eclipse Login Interface Screen

2. **Download:** Locate and Download the Vegatouch Mira/Eclipse App from the Google Play or App Store. Once download is complete, install the app and open it.

3. **Setup:**

- Tap SCAN to find the Mira/Eclipse Module's Bluetooth signal. After scanning, any interface module in your Bluetooth range will appear on the screen (Fig. 1).
- Tap the ID number that matches the one on your Vegatouch Module. Enter the Default PIN number (777777) (Fig. 2).
- Then press AUTHENTICATE to connect to the Vegatouch module (Fig. 3).



Vegatouch Module

iOS Setup Tips:

Turn ON Bluetooth to allow Vegatouch Mira/Eclipse to connect to Accessories.

If you do not have Bluetooth turned ON in your iOS Settings, you will see this screen on your device: Do not click OK; you MUST click SETTINGS. Your Bluetooth Settings page will now appear and you should turn Bluetooth ON.

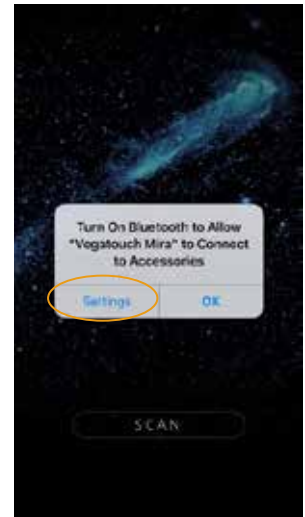

Figure 1



Figure 2



Figure 3



NOTE: Location Services Required:

To enable Location Services on your Apple device:

1. Go to SETTINGS/PRIVACY/LOCATION Services.
2. Make sure that Location Services is ON.
3. Scroll down to find your app.
4. Tap the app and select "Always allow access to your location."

Android Setup Tips:

- Allow Vegatouch Mira/Eclipse to access this device's location.
- Mira will need to be allowed access to your location. Click ALLOW when you see this screen.

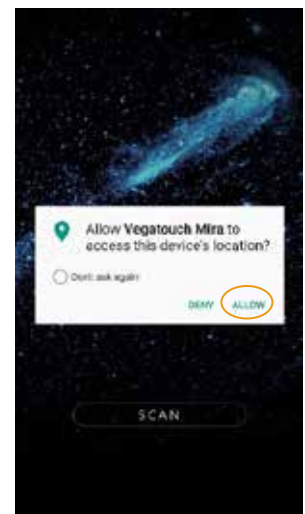

To enable Location Services on your Android device:

1. Open your phone's Settings app.
2. Tap Location/App Permission
  - If you don't see 'Location', tap SECURITY & LOCATION/LOCATION.
  - If you have a work profile, tap ADVANCED/LOCATION.
3. Under 'Allowed all the time' and 'Allowed only while in use,' view the apps that can use your phone's location, tap it, then choose the location access for the app.
4. To change the App's permissions, tap it, then choose the location access for the app.

**App Settings:**

Access the App Settings page (on your phone) by tapping the triangle at the bottom of the screen, to expose the Settings Button. Tap the gear icon to go to the app's Settings page.

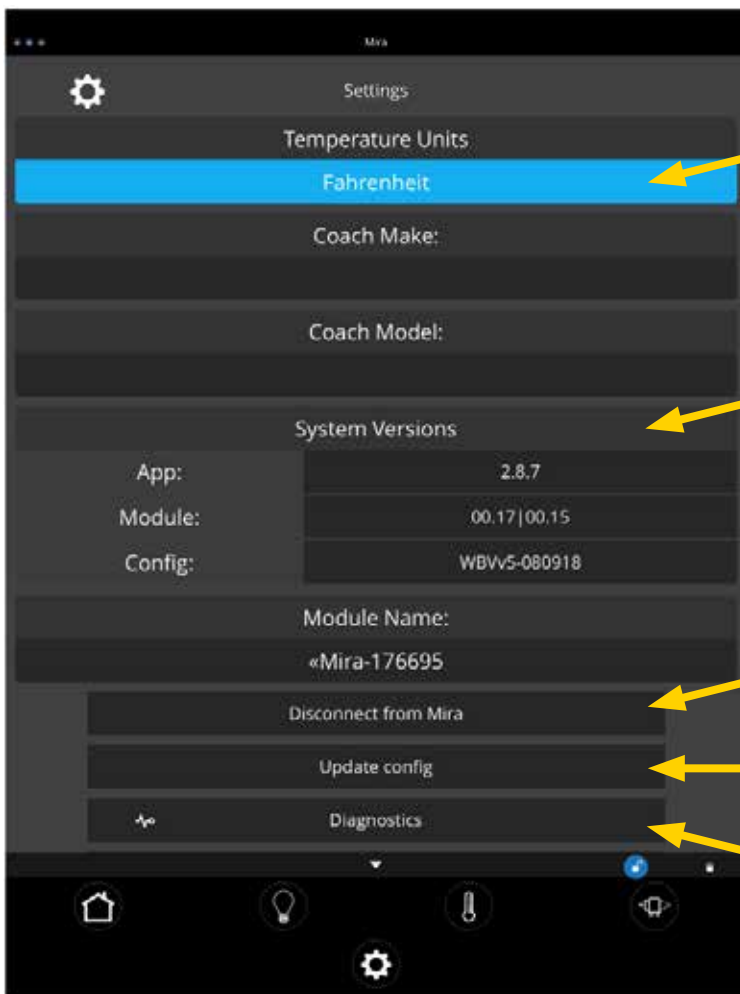

Tap the Temperature Units selection to choose between Fahrenheit and Celsius.

System Information and module Name.

Tap to disconnect your device from the Module.

Tapping Update Config will force a download of the config from the cloud.

Tap to enter the Diagnostic Tools Screen.

Vegatouch Phone App Settings Screen

## Firefly Diagnostic Tools

### Remote Help:

If instructed by Firefly, on your Vegatouch Phone App, tap Enable Remote Help for advanced technical support. Once enabled, provide the Session ID to allow Firefly to remotely connect to your app (Internet connection required).

To disable Remote Help, simply tap the Session ID Number from the HOME PAGE of your app.

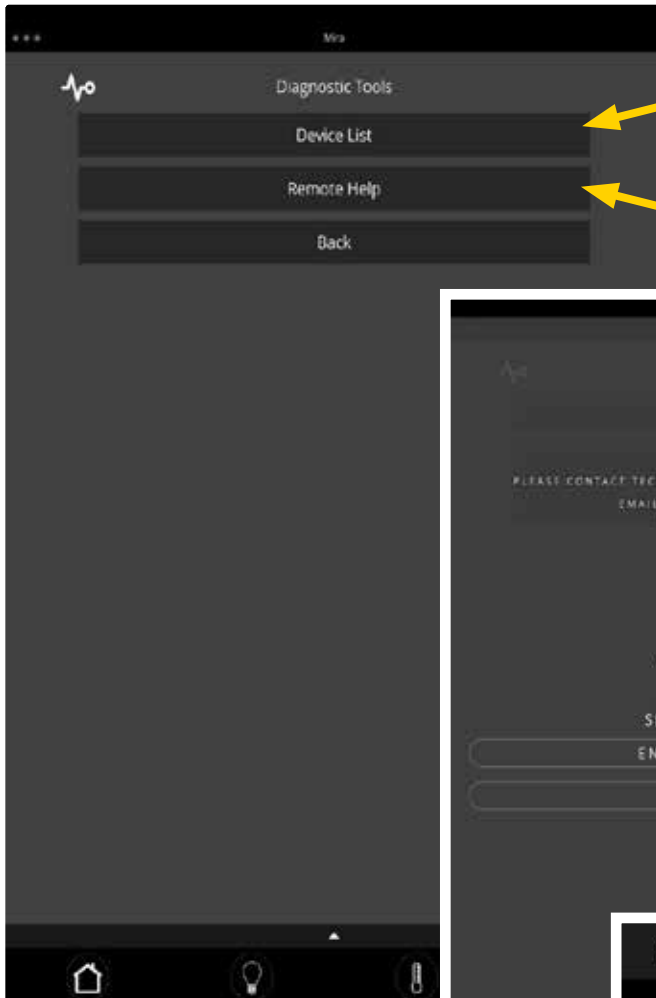

Tap to display a list of currently connected devices.

Remote Help is available by calling Firefly Integrations. Do not enable remote help without consultation from Firefly.

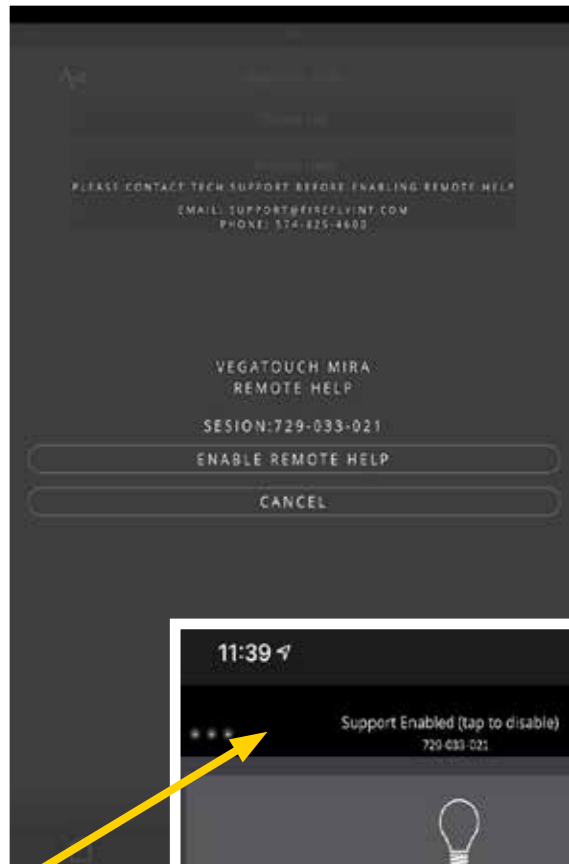

Tap on Session ID Number to disable Remote Help.

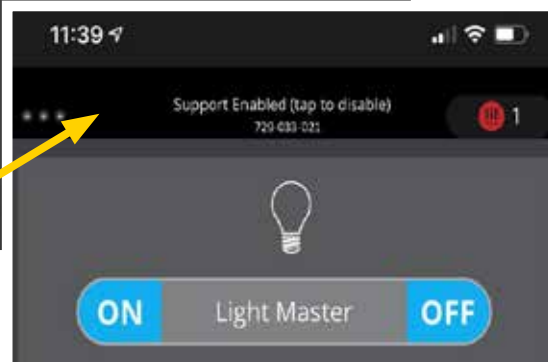

# BMPro Multiplex Systems

## Touchscreen Controller Navigation



*NOTE: Lighting and motor control switches (#9 and 10) can be operated immediately after the Touchscreen Panel is powered. It is not necessary to wait for the Master App to launch (boot-up).*

*NOTE: Graphics and displayed features may vary, due to standard and optional features of the motorhome and software or hardware versions or upgrades to the multiplex system.*

- 1 Controller Home Screen Button**
- 2 Connection Bar:** When connected to Bluetooth, the icon will appear on screen. When connected to the cloud, the icon will appear on screen. Both icons will appear when both services are available.
- 3 Settings Icon:** Access to the SmartConnect App General Settings. This button is only available on the Home screen.
- 4 Return Button:** Navigate to the previous page.
- 5 Main Screen Button:** Navigate to the Controller's tablet Android screen.
- 6 Recent Applications Button:** Display a list of recently used/background applications on the Controller.
- 7 Reset Pin Hole:** To reset the Controller, vertically insert an item (eg. a paper clip) into the reset pinhole.  
*NOTE: The item must be inserted vertically as the reset hole is in a plastic housing.*
- 8 Control Panel (Model Dependent):** To provide quick access to lights and motor operation while the Controller is in use. Any button press on the Control Panel will turn the tablet on if it has turned off.
- 9 Lights (Model Dependent):** Turn lights ON and OFF for four separate circuits (Living, Kitchen, Bath, Bedroom).
- 10 Motor Operation (Model Dependent):** To extend (EXT) and retract (RET) any motors installed in the motorhome, usually reserved for the patio awning.  
*NOTE: These buttons are also used during the pairing process between the Node and devices such as the Controller and smartphone.*
- 11 Navigation Buttons (Model Dependent):** Press either key to gain access and navigate through menu functions available from the Control Panel.
- 13** Press > to navigate forward and < to navigate back through the menu functions.  
For more information on available functions, see Menu Functions.
- 12 Menu Display (Model Dependent)**

## BMPro RVMaster System Diagram

The RVMaster Multiplex Control System consists of these major components:



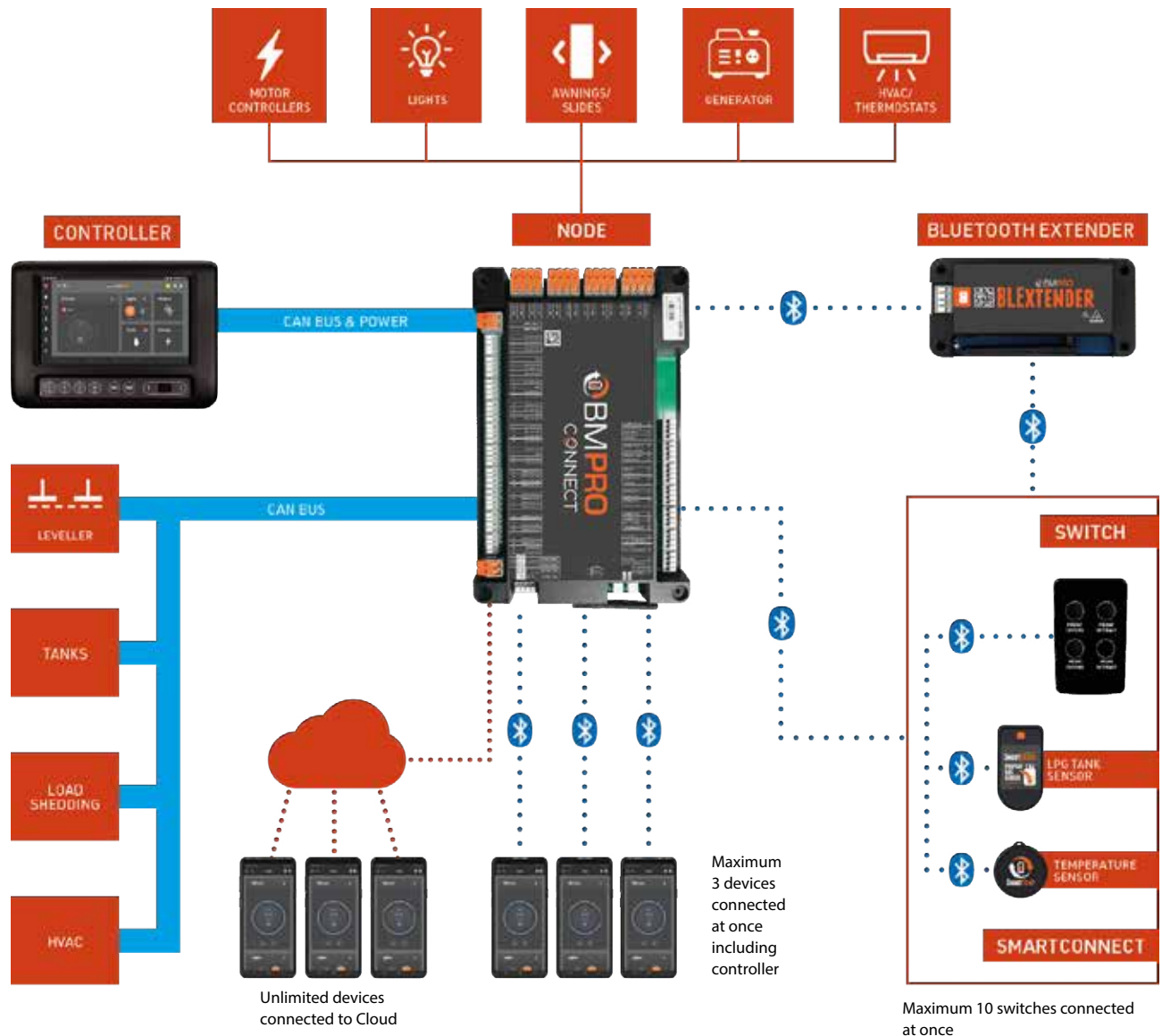





- **APP:** Tablet and smartphone app that allows remote control of the features and functions of the RVMaster multiplex system (referred to as the RVMaster App) for up to 4 Bluetooth-linked devices.
- **SMARTCONNECT:** Interface with installed (and optional) Bluetooth sensors for remote monitoring of tire pressure, tank levels, and HVAC temperature settings.
- **NODE:** Main system controller; powers and interfaces with the electrical devices installed in the motorhome.
- **TOUCHSCREEN CONTROLLER:** An android-based touchscreen user interface that allows easy user control and monitoring of the motorhome's electrical systems.
- **WALL SWITCHES AND SENSORS:** Installed switches and smart sensors that are Bluetooth-linked to the Node, allowing lighting and fan control from locations throughout the motorhome.



## RVMaster Control Screens



A sidebar located along the left edge of the touchscreen, provides easy navigation to all the main screens of the RVMaster App.

-  **The Home screen:** Provides a general overview of the key features of the motorhome.
-  **The Tanks screen:** Allows control of connected pumps and heaters.
-  **The Motors screen:** Allows control of awnings and leveling systems.
-  **The Climate screen:** Allows control of the air conditioning and furnace units inside the motorhome.
-  **The Fans screen:** Allows control of ventilation fans, is within the Climate screen.
-  **The Lights screen:** Allows control of lights inside the motorhome.
-  **The Sensors screen:** Allows viewing and configuring of connected SmartConnect sensors.  
  
NOTE: For more information on SmartConnect sensors, refer to the SmartConnect user manual available from BPro's website.
-  **The Energy Center screen:** Allows monitoring of energy usage (batteries and solar charging).

## Control Panel Functions

The menu functions on the Control Panel allows the immediate operation of slideouts, and awnings, quickly turn light circuits on or off, and are used for device pairing or clearing of pairings to the RVMaster Node (master controller).



**AWNINGS:** Navigate to the desired awning, then press EXT or RET to operate.



**BUNK-LIFTS:** Navigate to the desired bunk-lift, then press EXT or RET to operate.



**STABILIZING JACKS:** Navigate to the desired jack, then press EXT or RET to operate.



**SLIDEOUTS:** Navigate to the desired slideout, then press EXT or RET to operate.



**OF:** To turn off all loads, such as lights and fans controlled by the Touchscreen Controller.

- The Node will also turn off. The OF function does not shut-down generators controlled by the Touchscreen Controller.
- Navigate to the OF function, then press EXT to confirm that power to all accessories should be turned off.
- The Touchscreen Controller can be turned back on by pressing any of the Light buttons on the Control Panel.



**PA:** To pair the Touchscreen Controller with the RVMaster Node or a smart phone, or to clear the Touchscreen Controller of any pairings.

For more information, see the manufacturer's instructions, included with your Owner's Packet.

## The RVMaster App

The RVMaster App (SmartConnect App) is the software that communicates control signals to the RVMaster Node. This software is factory-loaded to the Touchscreen Controller installed in the motorhome. The touchscreen controller is also factory paired (Bluetooth) to the RVMaster Node.

The RVMaster App can also be installed onto a personal smartphone or tablet, allowing either Bluetooth-paired control of the RVMaster Node or control via Wi-Fi.

Download the RVMaster App and enjoy the freedom to monitor and operate your motorhome's on-board features and accessories, on-the-move, from your own smartphone or tablet.

### Compatible devices:

The RVMaster App is compatible with Android 8.0 or later and iOS 11 or later. Depending on your device, point your QR Code reader to one of the codes below to download and install the RVMaster App.

*NOTE: Available features on the App may vary depending on your RV model.*



### Connecting to the Internet:

The Controller has Wi-Fi capabilities to connect to the Internet and download the latest app updates.

### Updating the Touchscreen Controller:

To automatically receive the latest updates for the RVMaster App, connect the Touchscreen Controller to the Internet and log in to your Google account. You can also get the latest updates direct from the Google Play Store. Search for RVMaster in the Google Play Store and press Update.

*NOTE: For more information, see the BPro Operational Guide available through your TMC Owners Resource account.*

## RVMaster App Touchscreen Controls



### Boot-up:

1. Turn ON the Main Battery Switch, powering the 12-volt DC electrical system of the motorhome.
2. If the touchscreen is blank, touch anywhere on the screen. The controller's default desktop, or Main Screen, or Android Tablet Screen, may look like the illustration above. Booting up or awaking the controller may take up to 45 seconds.
3. Touch the RVMaster App Icon.



*NOTE: Access to your Google Account, Main Settings, and other features are from the Controller's Android Main Screen.*

## BPro Basic Multiplex System Operation

1. Ensure power is ON, either from 12-volts DC (main battery switch) or 120-volts AC (shore or generator power). With a power source ON, locate the Touch-Screen Panel and tap on the display area.
2. After Boot-up, the default, or Home Menu screen will display, which allows basic system control functions.
3. Along the left edge of the display are several menu icons. Tapping on these icons will display control menus, such as Lights, Climate Control, Electrical System controls and monitoring.
4. Return to the Home menu by tapping the 'Home' icon, located along the left edge of the screen.

5. Tapping the Main Screen icon, (#5 in the illustration) navigates back to the android tablet's home screen. From the tablet's home screen, access to Wi-Fi, Internet and other functions and settings are accessible.
6. Control panels with additional switches along the bottom allow for:
  - Control of 4 lighting zones
  - Extension and retraction of the patio awning
  - Pairing to the Master Node

These switches can be operated immediately after the master battery switch is ON and do not require waiting for the Touchscreen Panel and Master App to boot-up and launch.

- a. Buttons 1-4: Press ON/Press OFF to control 4 separate lighting zones.
- b. Press the left or right arrows to display A1 (Awning). Press and Hold EXT to extend the awning. Press and Hold RET to retract the awning.

*NOTE: Ensure the Bluetooth icon is displayed (item 2 in the Touchscreen Controller illustration). This shows that the Touchscreen Controller is Bluetooth-connected to the RVMaster Node. If the Bluetooth icon is not displayed, the Touchscreen Controller will need to be paired to the RVMaster Node (see Pairing Section).*

The multiplex system installed in the motorhome may include individual wall-mounted wireless switch panels located in the cabin or bathroom, controlling lights or fans. Like the main control panel, remote switches are linked to the RV Master Node (system control module) by wireless Bluetooth signals.

Multiplex system details are described in the manufacturer's owner's manuals included with your TMC Owner's Packet. Multiplex system how-to videos are also available on TMC's YouTube site:

[www.youtube.com/user/ThorMotorCoach](http://www.youtube.com/user/ThorMotorCoach)

*NOTES and TIPS:*

- The BPro multiplex system allows for remote control of all system functions via the SmartConnect (RVMaster) App. Although the main control panel is android-based, apps can be downloaded to either an android or iOS smartphone. Refer to the manufacturer's information included in your Owner's Packet or from your TMC Owners Resource account.
- Smartphone pairing is made directly to the RVMaster Node. Therefore, remote control is usable whether the main touchscreen control panel is on, off, or non-functioning.

- Up to three smartphones can be paired to the RVMaster Node.
- The main touchscreen controller is also Bluetooth paired to the RVMaster Node. If pairing is lost or unsuccessful, update the system's software app, then re-pair to the RVMaster Node.
- The following information about the Touchscreen Controller's internal batteries may not apply to your touchscreen; some versions are hardwired to the motorhome's auxiliary battery.
  - Like any tablet, the main touchscreen panel can run low of battery power. If the panel seems 'dead,' it is also likely that the motorhome's auxiliary battery(ies) need recharging. Recharging the auxiliary battery(ies), by plugging into shore power, should also restore battery power to the multiplex touchscreen controller. While waiting for the battery(ies) to recharge, the system can be controlled remotely via a paired smartphone.
  - Like all battery-powered devices, extreme cold temperatures can affect battery life.
  - If the multiplex control panel still is 'dead' after 4 hours of charging, it likely needs repair or replacement. Contact TMC's Customer Care: [wsupport@tmcrv.com](mailto:wsupport@tmcrv.com) or a BPro service technician: [service@teambmpro.com](mailto:service@teambmpro.com)
  - Although the multiplex touchscreen panel can be removed from its wall mount, the manufacturer discourages removal; possible tablet damage can occur.
- Helpful user guides and videos can be accessed via this link: <https://teambmpro.com/products/rv-multiplex-system-rvmaster/>

## Pairing to the RVMaster Node

### NOTICE

The Touchscreen Controller will have been paired to the RVMaster Node at the factory. You should only need to pair your own device or smartphone to the RVMaster Node.

Pairing the Touchscreen Controller, smartphone, or tablet to the RVMaster Node is done in two easy steps. The RVMaster App will guide you through the pairing process.

While the RVMaster Node can be Bluetooth-paired to a total of four devices (including the Touchscreen Controller), pairing must be done one device at a time.

1. Launch the app on your smartphone.
2. Using the < or > button on the Controller, navigate to the 'PA' menu item.



3. When 'PA' appears on the display, press the EXT button to start the pairing process to the Node. 'PA' will blink for a maximum of 30 seconds or until a device is connected.



4. When pairing is successful, you will be taken to the home screen and the Bluetooth icon will be visible.

Your smartphone or tablet device is now connected.

Bluetooth Icon displayed indicating a successful pairing



### Cannot Pair to the Node:

If you are pairing a mobile device to the RVMaster Node and pairing fails, or "--" appears on screen, it is mostly likely that four devices are connected to the Node simultaneously. To resolve this, either:

- Close the app on one of the devices that are connected to the Node and try again, or
- Clear the memory of the Node of all the previously paired devices.



## Remote Wall Switch (RVMaster Switch)

The motorhome may have one or several wall-mounted remote switches installed, typically in the bath and bedroom or bunk areas. The RVMasterSwitch is an optional wall switch available in three types of configurations to complement the motorhome's floor plan. The RVMasterSwitch communicates by Bluetooth to the RVMaster Node to provide convenient control of electrical features and accessories.

Any RVMasterSwitch installed in your motorhome will have been paired to the RVMaster Node at the factory and is ready to use immediately.

The RVMasterSwitch is powered by a standard, 3V Lithium Cell coin battery (CR2032). You can check if the battery needs replacing from the RVMaster App General Settings.

Open the BLE Wall Switches settings, then press any button on the switch whose battery you are checking. The RVMaster App will refresh with the switch battery status changes (installation of a new battery, for example).

To replace the battery:

1. Unclip the RVMasterSwitch button pad as shown in the illustration below.
2. Using a flathead screwdriver or similar tool, pry open the RVMasterSwitch button pad and remove the battery from the battery holder.
3. Insert the new battery in the battery holder with the positive side facing up.
4. Snap the switch pad closed.
5. Check the battery monitor to confirm the battery status.



Battery powered wall switches settings. LOW indicates that the battery in the wall switch needs replacing.



BMPro remote switches may be located throughout the motorhome. Switch functions vary by floor plan features and location within the motorhome.

## Pairing a Wireless Switch to the RVMaster Node

You may find that a wireless wall switch becomes ineffective in controlling the function it is designed to do. This may happen if the internal battery requires replacing or for some other reason that pairing to the RVMaster Node has been lost.

1. Using the Page Navigation button, navigate to the SETTINGS menu.
2. Using the Menu Navigation button, navigate to the ADVANCED selection.
3. Within the ADVANCED menu, again use the Menu Navigation button to navigate to the PAIR SWITCH selection.
4. Press the ACTION Button next to OK to put the RVMaster Node into SWITCH PAIRING mode.
5. While in PAIRING mode, PRESS any two buttons at the same time on the wireless switch you want to pair.



## BMPro Cloud

### **NOTICE**

**Keep your password in a safe place and only share details with others if you want them to access and control your motorhome!**

Cloud control allows you to remotely connect, monitor and control your RV from your smart device.

Connecting to the BMPro Cloud:

To connect to the BMPRO Cloud for the first time:

1. Connect your Controller to the Internet via Wi-Fi.
2. Launch the RVMaster App.
3. From the App Home Screen, press the Settings icon. 
4. Press Remote Connection.
5. Press Create account.



6. Enter your full name, email address and a password of your choice.
7. Press Create account.

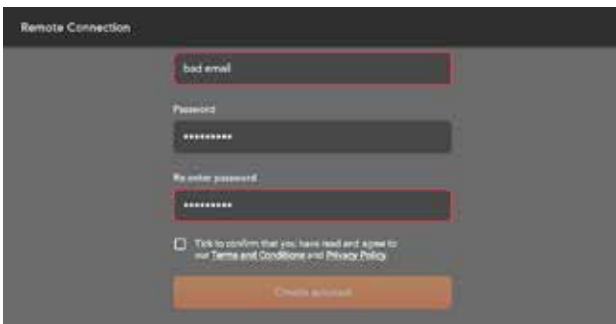

8. An email will be sent to your account to verify your email address. Click on the link provided in the email to complete verification.
9. Now connect your smart device using your BMPRO account details to get started.

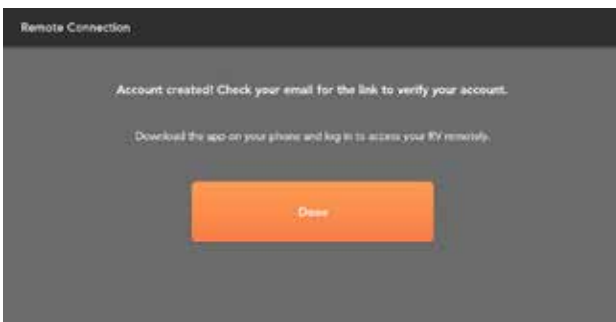

### Account Not Verified:

If the email address was not verified, a message will appear.

Press RESEND VERIFICATION EMAIL to complete the email verification process.

### Forgot Your Password:

If you have forgotten your Cloud account password, press Forgot your password in the login page, enter your email address and press SEND EMAIL.



To control the RV from cloud:

1. Launch the RVMaster App on your smart device.
2. Press Log in to BMPRO Cloud, or in General Settings, press Remote Connection.

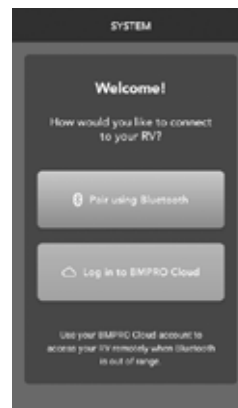

OR

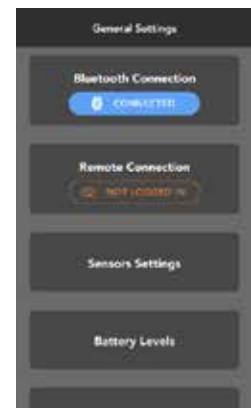

3. Enter your email address and password.
4. Press Log in.



**SUCCESS!**

Use cloud control to remotely monitor and control features in your RV.

For your safety and for the prevention of unintentional damage, the leveling, motor controls and the water pump ON switch cannot be controlled from the cloud.

### Winegard WiFi Extender Set-up

Setting up your Winegard WiFi Extender from your BMPro Controller for the first time:

1. From the Home Screen, press the Settings Icon. 
2. Press **Winegard Settings**.

#### Logging into the Winegard Network

1. Press the search button to search for the available networks.
2. Selectd the desired network and enter the password or enter the network name and password. If your network is not seen. make sure the Winegard is turned ON and scan again.
3. After the network name and password are entered correctly, press **JOIN**.



### Internet Preferences

You can select from the following options:

- **4G:** Connect to a 4G network. SIM Card required.
- **WiFi:** Connect to an external WiFi network.
- **Internet OFF:** No internet source selected.

### Winegard Status

The current status of the Winegard is displayed on the Winegard tile in the General Settings area.

- **SETUP:** This is seen when no Winegard network has been connected previously. Press the tile to connect to a Winegard network
- **UNAVAILABLE:** This means that the Winegard network is not available and may be seen during a transition from one mode to another. If Unavailable is displayed for a long time, check that the Winegard module is ON.
- **FETCHING INFO, CONFIGURING:** This may be seen during a transition from one mode to another, e.g. changing from WiFi to 4G.
- **4G:** This is seen when the Winegard is set to 4G. The status of the network is also displayed, e.g. Connected to 4G/LTE "NetworkName Data Plan."
- **WiFi:** This is seen when the Winegard is set to WiFi. The status of the network is also displayed, e.g. Connected to WiFi "NetworkName."
- **Internet OFF:** This is seen when the Winegard is set to WiFi. The status of the network is also displayed Internet is off.

### WiFi Properties

To log in to a WiFi network:

1. Press the Search button for a list of available networks and select your desired network.
2. If your network is not seen, make sure the Winegard is turned on and scan again.

### Save and/or forget WiFi Network

After the WiFi credentials are entered, the WiFi network will be saved.

- Press Join to connect last saved network.
- Press X to delete the saved network.

Multiplex systems information courtesy of Firefly Integrations and BMPro USA.

*This page is intentionally blank*

# Chapter 11: Electrical Systems

*DISCLAIMER NOTE: Electrical power systems, electrical system components, and auxiliary battery(ies) are subject to change without notice and Thor Motor Coach reserves the right to make changes, component substitutions, and improvements to its motorhomes built and/or sold at any time without incurring any obligations to make the same or similar changes on vehicles previously built and/or sold by TMC. The electrical system installed in your motorhome may differ slightly or significantly with the descriptions and information contained in this section.*

## WARNING

**Whether a device or appliance operates on 120 volts AC or 12 volts DC, great care must be observed while using any electrical device and working with electrical wires and connections. Although all electrical circuits of your motorhome are protected by either fuses or circuit breakers, the electrical system has the potential of delivering dangerous electrical shock or the possibility of fatal electrocution. A qualified electrical technician should perform all maintenance and repairs to the wiring, devices, or components of the electrical system.**

## NOTICE

**During very cold or very hot weather conditions, the image on touchscreen control panels (radio, multiplex, and other liquid crystal display (LCD) panels may appear unclear or react slowly. Once the interior temperature of the motorhome stabilizes, normal LCD panel display and operations will resume.**

Your motorhome's electrical system is designed to provide safe, reliable energy to power the mobile features that enhance the RV'ing experience. The electrical system is a blend of two distinct electrical platforms, consisting of a 120 volt alternating current (VAC) system, and a 12 volt direct current (VDC) system. The 12-volt DC system is further segregated into the house (coach) and the vehicle segments. Both the AC and DC power systems are required for your motorhome to function as intended.

Most of the electrical components of your motorhome are designed to operate on 12 volts DC. This includes lights, furnace and water heater control, water pump, powered ventilation fans, awnings, and some appliances. While other features, like the microwave oven, air-conditioner, TVs, and DVD players operate on 120 volts AC. Provided with your motorhome are power outlets for both 120 volts AC and 12 volts DC; so that you can conveniently power portable appliances you bring along while traveling.

If you have questions about the safe operation or maintenance of any electrical feature or component, please refer to the component manufacturer's user guides and manuals, many of

which are available through your TMC Owner's Resource on-line document service.

Or, contact your selling dealer or TMC's Customer Care for answers to any question you may have regarding the electrical or other system, feature, or component of your motorhome. TMC Customer Care representatives are available 24 hours a day, 7 days a week at:

Telephone (toll free): 877-855-2867

Email: [wsupport@tmcrv.com](mailto:wsupport@tmcrv.com)

You can also contact TMC's Customer Care by filling out and submitting the on-line form located here:

[thormotorcoach.com/company/contact-us](http://thormotorcoach.com/company/contact-us)

*NOTE: Due to model variations, options, and continuous production changes implemented by TMC, wiring diagrams are not included in this manual. Any specific questions you may have regarding the electrical system of your motorhome **THAT IS NOT COVERED IN THIS OWNER'S MANUAL**, should be directed to your Dealer or to TMC's Customer Care.*

## 12-volt Electrical System

Power for the 12-volt DC electrical devices installed in your motorhome is provided by either the on-board auxiliary battery(ies) or by the AC-DC converter, which is active when the motorhome is connected to shore power or when the generator is operating.

Other 12-volt electrical system devices are designed to control and regulate 12-volt power to and from the motorhome's auxiliary (house) and chassis batteries. Battery power management provides these important functions:

- Turn the 12-volt power system ON and OFF
- Control 12-volt electrical devices
- Manage battery power output
- Monitor battery charge condition
- Charge the auxiliary and chassis batteries

Information contained in this section describes these functions, giving the reader a good understanding of the electrical system and electrical components that are factory-installed in your TMC motorhome. Please note that several features described in this section can either be standard or optional equipment, meaning that your TMC motorhome may not include all the electrical system features and components described herein. Also, because the information is written to cover a wide range of motorhome brands and floor plans, the descriptions are broad in scope and may exclude certain fine details.

## Master Battery Switch

### **⚠ CAUTION**

Turning the Master Battery Switch OFF does not totally isolate the battery from the entire 12-volt system. Some devices, such as the solar charge controller, are connected directly to the battery. Use caution when performing maintenance on the 12-volt system of your motorhome.

### **NOTICE**

When traveling, the master battery switch must be turned ON to operate the dash radio and backup camera system (if equipped).

The master battery switch is typically located just inside the motorhome's main entrance. It is used to connect power from the auxiliary (house) battery(ies) to the motorhome's 12-volt DC electrical fuse panel, hereby providing power to the motorhome's interior lighting and other 12-volt DC devices. Although the style of this switch may be a rocker-type or a rotary switch, the function remains the same.

- When the switch is in the ON position, the auxiliary (house) batteries are connected to 12-volt devices that are powered through the 12-volt fuse panel.
- When the switch is in the OFF position, the auxiliary (house) batteries are disconnected from the 12-volt fuse panel.

With rocker-style master battery switches, power connection to the 12-volt fuse panel is accomplished through a battery relay, which is controlled by the master battery switch. The battery relay is located in the battery compartment and can be identified by the direct connection of the positive battery cables to it.

When connected to 120-volt shore power or the on-board generator is being used, the 12-volt system is powered through the AC-DC Converter, therefore, the master battery switch is not controlling 12-volt system power. However, when connected

to shore power or operating the on-board generator, charging voltage is provided to the auxiliary battery(ies) whenever the master battery switch is ON.

#### Using the Master Battery Switch:

It is good practice to turn the master battery switch ON when first entering the motorhome and leave the switch ON whenever the motorhome is occupied, whether parked or traveling.

- This will energize the 12-volt electrical system, so that interior lights, appliance control circuits, and other 12-volt devices can be used.
- This provides charging voltage to the auxiliary battery(ies) via the vehicle's alternator (when traveling) or by the converter when connected to shore power or using the on-board generator.
- This will provide power to the dash radio, which is powered by the auxiliary battery(ies). Therefore, keeping the master battery switch ON while the motorhome is in motion, will allow the use of the dash radio and driving cameras, which in most installations, use the dash radio display for rear-view and side view camera monitoring.
- When leaving the motorhome unattended for a few hours or more and not connected to shore power, turn the master battery switch OFF to conserve battery power, unless 12 volt power is needed to keep an appliance, such as the refrigerator, operating.
- When connected to 120-volt shore power or the on-board generator is being used (if equipped), the 12-volt system is powered through the AC-DC converter, therefore, the master battery switch is not controlling 12-volt system power. However, when connected to shore power or operating the on-board generator, charging voltage is provided to the auxiliary battery(ies) whenever the master battery switch is ON.

*NOTE: On select diesel motorhomes, the master battery switch and 12-volt circuit breakers are located on a panel installed in a service bay of the motorhome.*



Typical master battery disconnect switches; rotary and rocker-type. Rocker-type switches control a relay, which in-turn, turns on and off power from the auxiliary battery(ies).

Master battery switch located on 12-volt circuit breaker panel.



## Touch N' Go Control™: Dash Radio and Monitoring System

Select TMC Class A and Class C motorhomes offer systems monitoring and control functions accessed by the touchscreen of the dash radio. Referred to as Touch N' Go Control, this monitoring system is based on the Namsung AVM2210H Multimedia Receiver, with the addition of the AGS15 Control System. With Touch N' Go Control, the dash radio's touchscreen display not only serves as a complete entertainment portal, rear-view camera monitor, and navigation system (through a connected Apple or Android smartphone), it also includes electrical and water systems monitoring and other RV control functions. Although not a true multiplex system, Touch N' Go Control does include many multiplex-like features in a convenient and easy-to-use monitoring device, without the complexity of a true multiplex wiring system.

Monitoring and control features vary, depending on available floor plan features and options, but most systems include:

- Auxiliary (house) and chassis battery voltage
- Fresh and wastewater tank level monitoring
- LP tank level monitoring
- Holding tank heaters ON/OFF (if installed)
- Water pump ON/OFF
- Water heater ON/OFF
- Slideout(s) EXTEND/RETRACT (if installed)
- Emergency Start
- Shore power faults (low voltage, open grounds, etc.)
- Generator START/STOP
- Automatic Generator Start (AGS) ON/OFF and AGS settings
- Remote control and monitoring via Bluetooth enabled Smartphone app (Apple or Android)



Namsung AVM2210H Dash Radio with AGS15 Head Unit Control

## Basic Operation

1. Turn ON the Battery Switch (Note: all TMC dash radios are powered by the auxiliary (house) battery).
2. Turn ON the AVM2210H Dash Radio.
3. Swipe through the available screens and locate the RV Control Icon and tap to enter the RV Control Screen.



4. The Main RV Control Screen will appear. Located on this screen are the most frequently used system monitoring and control functions:
  - a. Holding tank monitors
  - b. LP tank monitor
  - c. Water pump, water heater, and holding tank heaters
  - d. Slideout controls
  - e. Emergency start switch
  - f. Shore power fault indicator

Other monitoring and featured controls may be displayed on this screen, depending on the standards and options available for your motorhome.

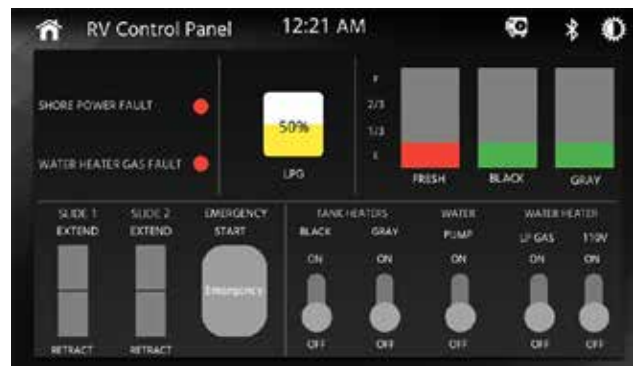

Illustration of the Touch N' Go Control's main screen. Monitoring and control features may vary depending on installed standard and optional features.

### Generator and AGS15 controls and settings:

1. Return to the Main Menu screens by tapping on the Home Icon, the house-shaped symbol located in the upper left corner.
2. Select the AGS Screen by tapping on the AGS Control Icon.
3. Controls on the AGS Screen allow:
  - a. Manually starting and stopping the generator
  - b. Engaging and disengaging AGS
  - c. Setting AGS operational parameters
    - i. Start/Stop generator at low battery voltage
    - ii. Run-time limits
    - iii. Quiet time
    - iv. Start temperature (for automated start/stop of air conditioner)
    - v. Maximum generator run-time limit. Useful for generator maintenance and service intervals.



AGS15, AGS settings screen

### AGS15 Remote Switch and Monitor:

Usually located just inside the entry door to the motorhome is a round AGS remote switch, which also includes several monitoring LED indicators.

In the center of this switch is a push-button that allows easy access to turn ON or OFF the AGS function. When AGS is engaged, a signal LED will illuminate on the switch panel.



AGS15 Remote Switch

A temperature sensor is also housed within this switch unit that provides a signal to the AGS system to turn on the generator, and thereby the air conditioner, when AGS is used to control motorhome cooling.

### Other monitoring features include:

- **Auxiliary Battery Voltage:** When the auxiliary (house) battery voltage is lower than the preset (AGS) generator start voltage, the indicator will be **RED**. If AGS is enabled, the generator will automatically start, charging the battery.  
The battery voltage indicator turns **GREEN** when the battery has reached it's normal (charged) voltage level.
- **Fresh Holding Tank Monitor:** When the freshwater tank level is Full to 2/3 Full, the indicator will be **GREEN**. When the freshwater level is 1/3 Full to Empty, the indicator will be **RED**.
- **Black Water Holding Tank Monitor:** When the black water tank level is Full to 2/3 Full, the indicator will be **RED**.  
When the black water tank is 1/3 Full to Empty, the indicator will be **GREEN**.
- **Gray Water Holding Tank Monitor:** When the gray water tank level is Full to 2/3 Full, the indicator will be **RED**.  
When the gray water tank is 1/3 to Empty, the indicator will be **GREEN**.

### Key Fob:

**For Class C Motorhomes only,** the AGS15 system may include a Bluetooth-linked Key Fob that allows remote control of **Class C** cab door locks and remote Start/Stop of the motorhome's generator.

- Door Lock →
- Door Unlock →
- Generator Start (long press) →
- Generator Stop (long press) →



## NOTES:

- Please review the manufacturer's instructional manual for information regarding remote monitoring and control features of the AGS15 system via an Apple or Android smartphone app.
- Connecting the Remote Mobile App to the AGS15 system requires an App Login Passcode. This passcode is printed on a Quick Start Guide, included in your TMC Owner's Packet and printed on a card placed the inside of the glove box. Retain this passcode in a safe and retrievable location.
- This monitoring system is normally supplied with one key fob and can accept two Bluetooth-linked key fobs (key fob not supplied with Class A motorhomes). If additional key fobs are desired, or a replacement key fob is needed, please contact your selling dealer.
- At the time of this writing, this dash radio-based monitoring and control system is only available on TMC Class C Ford E350/450 chassis-based motorhomes and TMC Class A Ford F-53 chassis-based motorhomes that are NOT equipped with a multiplex control system. When installed in a Class A motorhome, the key fob (remote door lock/unlock and generator start/stop) is not available.  
  
This system is NOT available with Chevy chassis-based Class C motorhomes. These motorhomes are equipped with the AGS10 system (Automatic Generator Control without dash radio monitoring).
- Beginning in mid-model year 2025, Ford Class C chassis' may be supplied with a Ford Factory Key Fob that provides keyless entry to the cab. These motorhomes may not be supplied with an AGS15 Key Fob. However, if a Ford Class C is supplied with both a Ford and AGS15 key fob, the remote door lock/unlock function on the AGS15 key fob is disabled. With all AGS15 installations, remote monitoring and generator controls are available through a smartphone app.

Information courtesy of Dual Electronics Corporation.

## Monitor Panels

Installed on motorhomes without multiplex electrical systems, monitor panels provide a convenient and centrally located place for electrical controls and monitoring of motorhome systems. Items that may typically be found on the monitor panel include:

- Holding tank level indicators and switch(es)
- Battery condition indicator (L=Low, F=Fair, G=Good, C=Full Charge)
- Water heater switches (electric & propane gas)
- Water pump switch
- Generator start / stop switch
- Generator hour meter
- Tank heater switches
- Light switches for some interior and exterior lights
- Slideout control switch(es)
- Shore Power Fault Indicator



Typical Monitor Panel for non-multiplex electrical systems.

## Battery Condition and Holding Tank Level Indicator:

The charge condition of the batteries can be checked with the Battery Condition Monitor. To check, press and hold Battery Test Switch while reading the charge level on the battery gauge LED. The indicator is divided into sections from weak through fully charged.

To operate:

1. Press and hold the BATT switch;
2. One of the 4 LEDs in the array will illuminate, indicating the charge condition of the auxiliary battery(ies);
3. Read the battery condition and release the switch.

Similarly, press and hold the corresponding holding tank switches to monitor levels.



Battery Condition LEDs:  
 L = Low F = Fair G = Good C = Full Charge

NOTES:

- The monitor panel can be used to check the condition of both the auxiliary battery and the chassis battery. A fully charged lead-acid battery will read 12.7 volts DC. A lead-acid battery is considered discharged at 11.8 volts DC by electronic standards.
- When voltage drops below these levels, permanent damage may occur. Due to their large energy storage capacity and depending on the rate of depletion, it may take up to 24 hours for a lead-acid battery to fully recharge.
- Monitor panel design, features, and functions vary depending on model year, make, and model. Motorhomes equipped with multiplex systems have control features integrated into the multiplex touchscreen panel.

## Multiplex Electrical System Monitoring

TMC installs a variety of multiplex systems in Class A and Class C motorhomes. Most, if not all multiplex systems include basic electrical system monitoring from the main or home screen. Electrical system monitoring includes:

- Auxiliary (house) battery voltage
- Chassis battery voltage

And may include:

- Links to the solar charging monitor screen
- Shore power condition, including (faults)
- Generator Start/Stop
- Automatic Generator Start (AGS) On/Off

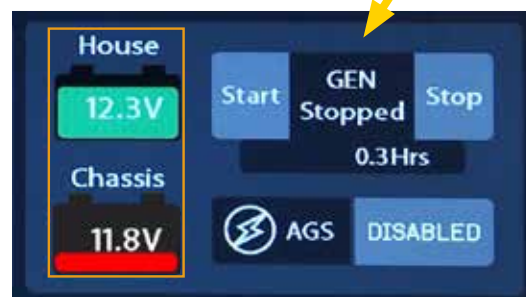

Typical multiplex main control panel. Basic electrical system monitoring is usually located on the main menu (Home) screen.

### Electrical Menu Screen

From the Home Screen, select the Electrical Menu Screen (usually an icon shaped like a lightning bolt). Depending on the installed multiplex system and installed features, a variety of electrical system monitoring and controls features are available.

Most multiplex systems include sub-menus and other electrical system selections accessed from the Electrical Menu.

It is beyond the scope of this manual to cover the details of electrical system monitoring and controls for TMC motorhomes. Please refer to the TMC Multiplex Systems Guides and multiplex manufacturer's instructions for electrical system monitoring and controls. This information is available through your on-line TMC Owners Resource account.

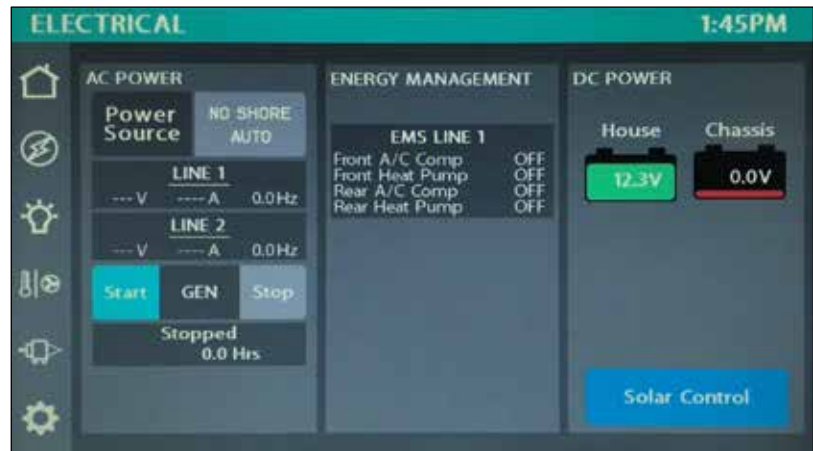

Examples of Electrical Menu Screens; Firefly Integrations (above) and BMPro (right).

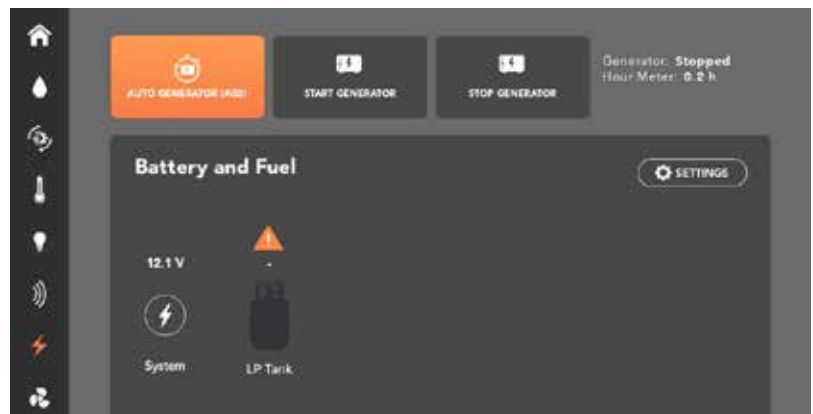

## Emergency Engine Start Switch

### NOTICE

**Turn off all 12-volt DC devices before using the emergency start feature. This will help ensure that all available energy stored in the auxiliary battery(ies) can be used for vehicle starting.**

**The Emergency Start feature may not be available on Class C motorhomes with Lithium-Ion auxiliary battery(ies). See Lithium Battery System Guide.**

TMC motorhomes may be equipped with an Emergency (auxiliary or AUX) Start. Located in the vehicle's cockpit, near the driver's seating area, this feature connects the auxiliary battery(ies) to the vehicle's starting circuit. Emergency Start is used in situations when the chassis battery is too depleted to start the vehicle on its own. Electrically connecting the auxiliary battery(ies) to the engine starting circuit often provides the needed energy to start the motorhome's engine. When the Emergency Start Switch is released, the auxiliary battery(ies) is disconnected from the engine starting circuit.

To operate:

1. Ensure the master battery switch is ON.
2. Depress the 'EMERGENCY START' switch, located on the front driver's dash and HOLD.
3. Use the ignition switch (key or start button) to start chassis engine.
4. Release the 'EMERGENCY START' switch after the engine has started.

NOTES:

- Select TMC Class A and C motorhomes feature the Emergency Start feature integrated into the dash radio display panel (see Electrical Systems Monitoring section).
- When using the Emergency Start feature, DO NOT hold the ignition key in the start position for more than 30 seconds.
- If starting cannot be accomplished, operating the generator for a few minutes may give the batteries the charge needed to start the vehicle.



Typical emergency start switch

Emergency generator starting:

The Emergency Start feature can also be used to deliver extra starting power to the generator. This is accomplished by electrically tying the chassis battery to the auxiliary battery via the Emergency Start Solenoid (this solenoid is actuated by energy from the auxiliary battery and controlled by the Emergency Start Switch). This feature is useful in circumstances when the auxiliary (house) battery is too depleted to start the generator.

1. Ensure the Master Battery Switch is ON.
2. Press and hold the Emergency Start Switch.
3. While holding the Emergency Start Switch in the ON position, DEPRESS the Generator Start Switch (see generator starting procedure). Since these two switches are not physically near each other, you may need the assistance of another person to operate one of the switches.
4. When the generator has started, RELEASE the Generator Start Switch and the Emergency Start Switch.
5. Keep the Main Battery Switch ON while the generator is operating. This will allow power from the generator to charge the auxiliary (house) and chassis batteries via the converter (or in some installations, the inverter).

If the auxiliary battery is completely dead, it will not have enough reserve power to engage the emergency start solenoid, therefore the generator starting method described above will not be successful.

An alternative method of emergency generator starting that will work for all TMC motorhomes except Class C's with Lithium-Ion auxiliary batteries.

1. Start the vehicle's engine and wait for the emergency start solenoid to engage on its own. This may take a few moments.

Running the vehicle's engine will allow energy from the vehicle's alternator to activate the emergency start solenoid, in turn, supplying charging energy to the auxiliary battery.

2. Allow the vehicle's engine to run for several minutes.
3. With the vehicle's engine still running and when the auxiliary battery has recovered an adequate charge, attempt to start the generator in the normal manner.
4. Once the generator starts, turn OFF the vehicle's engine. As long as the generator is running, charging energy to the auxiliary battery will be supplied from the generator via the converter.

*NOTE: The typical lithium-ion battery may not have the cranking amperage needed to start a generator with a diesel engine.*

## Auxiliary Battery(ies), AGM or Lead-Acid Type

### **⚠ WARNING**

- **DO NOT** store items in the battery compartment or near the battery(ies) that might come in contact with the battery terminals. This could cause an electrical short circuit, drain the battery, cause a spark, or ignite combustible materials.
- Keep sparks, cigarettes, and flames away from the batteries as the hydrogen gas they create may ignite.
- **DO NOT** connect a booster battery or other power source that outputs more than 14.2 volts DC to the motorhome batteries.
- Use adequate ventilation when charging or using batteries in an enclosed space.
- Remove metal jewelry and always wear eye protection when working around batteries.
- **DO NOT** allow battery electrolyte (acid) to come in contact with skin, eyes, fabric or painted surfaces. Electrolyte is a sulfuric acid solution that could cause serious personal injury or property damage.
- If your hands, eyes, clothes, or the painted surface of your motorhome are exposed to electrolyte, flush the exposed area thoroughly with water.
- If electrolyte gets in your eyes, immediately flush them thoroughly with water and get prompt medical attention.

As standard equipment, your TMC Class A or Class C motorhome is supplied with lead-acid (AGM), deep-cycle type storage battery(ies), similar to the batteries found in recreational boats and golf carts. Deep cycle batteries are designed to be less susceptible to internal damage when operated in cycles of near depletion (discharge) and full recharge. Depending upon the features installed, the motorhome may be supplied with more than one auxiliary battery. Auxiliary batteries are typically located in a battery compartment, consisting of a separate bay (Class A) or underneath an entrance step (Class C).

#### NOTES:

- A fully charged lead-acid battery will read 12.7 volts DC. A lead-acid battery is considered discharged at 11.8 volts DC by electronic standards.
- When voltage drops below these levels, permanent damage may occur. Due to their large energy storage capacity and depending on the rate of depletion, it may take up to 24 hours for a lead-acid battery to fully recharge.
- Keep the battery(ies) fully charged whenever possible. The on-board solar charging system is useful for this purpose. See Battery Charging Sections.

Typical Class A motorhome auxiliary (house) battery compartment



Typical Class C motorhome auxiliary battery location (under entrance step)

## Battery Maintenance

### **⚠ WARNING**

- **Battery electrolyte is a corrosive, poisonous, sulfuric acid. Avoid contact with skin, eyes, clothing, or any painted surface.**
- **Keep sparks, cigarettes, and flames away from the batteries as the hydrogen gas they create may explode.**
- **DO NOT** connect a booster battery or other power source that outputs more than 14.2 volts DC to the motorhome's AGM (lead-acid) batteries.
- **Use adequate ventilation when charging or using batteries in an enclosed space.**
- **Remove metal jewelry and always wear eye protection when working around batteries.**

- **DO NOT SHORT ACROSS THE BATTERY TERMINALS. The spark could ignite the gases. DO NOT wear metal jewelry, such as rings, watches, or metal wrist bands when working on a battery.**
- **Before doing ANY work on electrical system, disconnect battery cable and the 120-volt power cord. DO NOT reconnect the cables until all work has been completed. This will avoid the possibility of shorting or causing damage to electrical components or shock to the servicing person.**
- **ALWAYS WEAR SPLASH PROOF SAFETY GLASSES OR FACE SHIELD AND USE ACID-PROOF RUBBER GLOVES WHEN HANDLING AND WORKING WITH LEAD-ACID BATTERIES.**

Proper battery maintenance is important in order to ensure the battery retains its power delivery capacity while prolonging its useful life. Listed here are a few instructions for maintaining and servicing batteries. These instructions apply only to batteries which are NOT maintenance-free, or sealed batteries. The auxiliary batteries supplied with your motorhome may not be the sealed type, however, the chassis battery may be a maintenance-free, sealed type battery. DO NOT open or break seals on maintenance-free batteries.

1. Keep the battery mounted securely. Routinely check the battery terminals for loose battery clamps. Tighten when necessary.
2. Keep battery hold downs and trays clean and free of debris and corrosion.
3. Check the electrolyte level of the auxiliary batteries at regular intervals. Keep each cell filled to just above the plates with DISTILLED water only. Once the plates have dried out, they cannot be reactivated, and the capacity of the battery is reduced in direct proportion to the area of plate surface that has become dry. This kind of damage can occur quickly. If the fluid level is low, simply add distilled water.
4. Be cautious when removing battery fill caps. Pry off caps carefully. Forcing caps off can cause the electrolyte solution to splash. Electrolyte solution can burn, and even small amounts can damage eyes and skin. Always use proper personal protective equipment when working with batteries.
5. Keep the battery terminals clean. Corroded terminals make poor electrical contact and will prevent normal operation of the 12-volt system. Battery terminal corrosion occurs when the battery has been standing in a discharged condition over a long period of time, or when the battery has been operated continually in a state of partial discharge. Use a baking soda solution to neutralize the corrosion on the battery terminals and cable clamps. DO NOT allow the soda solution to enter the battery. Make sure the vent caps are secure. Flush with water. Thoroughly dry all cables clamps and terminals, reinstall, and use a battery terminal protecting spray or compound, available at automotive parts or auto service centers.
6. Check the outside condition of the battery. Look for cracks in the case or vent plugs. If the case is cracked, the battery must be replaced. If the vent plugs are cracked, they must be replaced.
7. For long battery life, it is important to keep your motorhome batteries fully charged as much as possible. Turn OFF lights and other 12-volts DC components when they are not being used. Connect the motorhome to a 120 volts AC power source (shore power) whenever possible, charging the battery(ies) via the AC-DC converter, or if the motorhome has access to sunlight, keep the solar charging system ON.
8. Watch for overcharging. Three indications of overcharging are:
  - a. Active material on the vent cap (heavy deposit of black lead-like material on the underside of the vent cap);
  - b. Excessive use of water or water escaping at vent caps;
  - c. Abnormal voltage regulator output.
9. When removing a battery, disconnect the ground battery clamp first. When installing a battery, always connect the grounded battery clamp last.
10. When replacing batteries, make sure the new battery is the same type and rating of the battery that was originally equipped with your motorhome. If in doubt, consult your RV dealer for advice on battery replacement.

#### NOTES:

- *Only use distilled water when filling battery cavities. Be careful not to overfill battery cavities and NEVER move or travel with a battery that is uncapped.*
- *Use a battery terminal conditioning spray (available at auto parts stores) to prevent battery terminal corrosion.*

## Battery Storage (AGM/AGS)

To prevent auxiliary (house) battery discharge when the motorhome is placed in long-term storage and **NOT** connected to trickle-charging through the shoreline power cord, turn OFF the main battery switch and disconnect the negative battery cable at the battery terminal.

However, while in storage, it is recommended to trickle-charge the battery(ies) through the shore power cord or the solar charging system. The main battery switch needs to be ON and DO NOT disconnect the battery terminals. This will allow the converter, or inverter (if equipped), or solar charging system (if equipped) to trickle charge the auxiliary (house) battery(ies).

## Battery Replacement

### **WARNING**

#### **TO PREVENT HAZARDS FROM DANGEROUS BATTERY GASES:**

**If replacing or adding batteries to the 12-volt electrical system, ensure batteries are always located in a well-ventilated area and separated from the living space of the motorhome.**

**Always add or replace batteries with the same type that was originally equipped with your motorhome. NEVER mix AGM/AGS batteries with Lithium-Ion batteries.**

When replacing batteries, make sure the new battery is the same type and rating of the battery that was originally equipped with your motorhome. If in doubt, consult your selling dealer or a qualified RV technician for assistance. Always re-connect the battery cables in the original factory-installed positions.

- **DO NOT** replace a deep cycle battery with a starting battery. Only use deep cycle batteries for the motorhome's house application.
- **DO NOT** replace the chassis or starting battery with a deep cycle battery. A starting battery is designed to deliver higher instant amperage, needed to start the vehicle's engine.
- Check to be sure the replacement battery will fit the battery tray of the motorhome. Group 24 batteries are physically smaller than Group 27 batteries.

## Battery Charging

It is important to keep the auxiliary battery(ies) in a condition of full or near-full charge. Doing so will ensure 12-volt DC energy is available when needed. Battery charging is accomplished by:

- Automatic charging through the converter or inverter (shore power or generator);
- With the vehicle engine running, auxiliary battery(ies) are charged via the chassis alternator (when master battery switch is ON);
- Auxiliary battery charging via solar charging system (equipped as standard, optional, or customer installed).

Take time to turn off all lights or other 12-volt accessories when not in use. Connect the motorhome to a 120-volt AC external shore-power source or run the generator whenever possible. Utilize the solar charging system (if installed). Doing so will keep the auxiliary batteries charged.

The standard AGM auxiliary batteries are typically the deep-cycle type and are capable of being deeply discharged and rebound to full capacity when recharged. Due to their large energy storage capacity, the auxiliary battery(ies) may take up to 24 hours to completely recharge.

If for any reason, you recharge a auxiliary battery with a charger or power source other than what was supplied as part of the motorhome's original electrical system, make sure to follow all safety, operational, and maintenance instructions from the battery and battery charger manufacturers, while ensuring charging parameters match the auxiliary battery type.

*NOTE: The master battery switch must be ON in order to charge the battery(ies) by any on-board method described in the following sections.*

## Charging by the Vehicle's Alternator

The motorhome's electrical system is wired so that when the vehicle's engine is running, and the chassis alternator is properly operating, charging voltage is supplied to both the chassis and auxiliary battery(ies). The master battery switch must be ON in order for the auxiliary battery to be charged by the chassis alternator.

When driving, if the alternator is not keeping pace with the draw on your motorhome's electrical system, it means it is working in a negative mode; more power is being used than the alternator is capable of supplying. If you draw too much power from your batteries, there may not be enough power left to start the motorhome or run the 12-volts DC appliances when you stop for a break or for the night.

The alternator will charge at a higher rate right after the motorhome has been started, replacing the power used to start the

vehicle, but the charging should quickly drop back to 'normal' and hold its own even when you turn on lights or appliances.

If the alternator shows a discharge while the vehicle's engine is running, turn OFF appliances and lights to see if a charge comes on or if the alternator indicates 'neutral.' Then apply a load (turn ON a 12-volt DC appliance) on the system to see if a discharge returns. If a discharge persists, your alternator may not be working correctly; contact your dealer.

## Charging by the AC-DC Converter

The AC-DC Converter is a 12-volt power supply, which operates on 120 volts AC and is designed to power the 12-volt system when the motorhome is connected to shore power or when the generator is running. The Converter also provides charging energy for the auxiliary (house) battery(ies).

If the battery condition is below its full charge, the battery charging function of the converter will begin recharging the auxiliary battery at a rate that reflects the level of discharge. When the battery is fully charged, the charger drops its charging level to a maintenance or trickle level, thus maintaining the battery(ies) full state of charge (SOC).

## Charging by Solar Energy

### **⚠ CAUTION**

**Battery type selection on the controller determines charging parameters that best suit the battery type. Incorrect battery type selection settings may damage the battery.**

### **NOTICE**

**TMC installed solar controllers are always wired on the "hot" side of the master battery switch, meaning solar charging is active with or without the battery switch being turned ON.**

TMC motorhomes are typically factory equipped with a solar battery charging system. Consisting of a solar charge controller, along with a roof-mounted solar panel(s). This system is designed to provide a readily available battery charging method for the auxiliary (house) battery(ies).

The solar charging system seamlessly integrates with the motorhome's 12-volt DC power system. The auxiliary batteries are automatically charged when the solar charge controller is ON. The solar charge controller provides monitoring of battery condition, monitoring of the charge energy being supplied by the solar panel(s), and regulation of the charging energy.

TMC installs two basic types of solar charge controllers:

- Stand-alone, PWM (pulse width modulated) with a 10 amp input rating. Installed in motorhomes without a multiplex wiring system.
- RV-C compatible MPPT (Maximum Power Point Tracking), with either a 10 amp or 30 amp input rating. Installed in motorhomes with a multiplex wiring system.

Where the stand-alone controller uses a built-in LCD display and front-panel switches to monitor and make system selections, the RV-C compatible controller interfaces directly with the motorhome's multiplex system, allowing monitoring and settings functions through the multiplex system's touchscreen display.

Both controller types feature charging parameters that can be selected for flooded, GEL, AGM, and lithium-ion batteries that contain an internal battery management system.

### Basic Solar Charging System Description:

*Solar controllers offer automatic, multi-stage charging parameters.*

1. **Bulk Stage:** This algorithm uses 100 percent of available solar power to recharge the battery and provides the maximum current available based on maximum input current settings. In this stage, the battery has not yet reached its maximum (constant) voltage rating (typically 12 volts).
2. **Absorption Stage:** When the battery reaches its constant voltage (typically 12 volts), the controller will start to reduce input current, while maintaining the battery at its constant voltage level.
3. **Float Stage:** After the Absorption Stage, the controller reduces the current even further so that the battery voltage can reach and be maintained at a minimum charging energy level. Some battery chargers refer this stage as a 'Trickle Charge,' where the controller is allowing just enough current to maintain the battery's charge.
4. **Equalization Stage:** This stage is carried out on a typical 30-day cycle (by default). When enabled, Equalization intentionally overcharges the battery for a controlled time-period. Certain types of batteries benefit from a periodic equalization

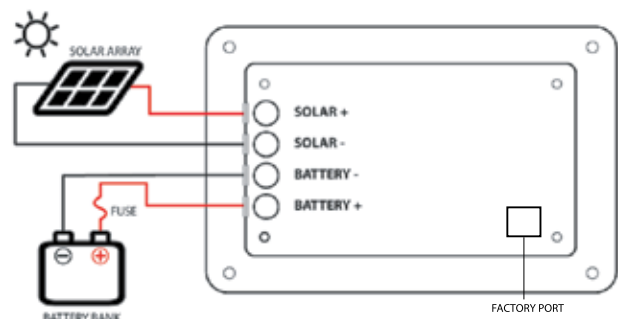

Typical solar charge controller wiring diagram.

charge, which can 'stir' the electrolyte, thus creating a more uniform chemical reaction within the cells of the battery.

Depending on the model, the maximum input current rating of the solar controller is 10 or 30-amps (energy supplied by the solar panel(s)). The typical factory-installed solar panel is rated for 100 watts (peak), with some solar panels having a rating of 200 watts (peak power). The output charge voltage is up to 14.4 volts DC. Solar panel(s) installed on your motorhome may vary from these specifications; refer to your Owner's Packet for details.

Maintenance and operational instructions from the solar controller and solar panel manufacturer are included with your owner's packet and also available on-line through the TMC Owners Resource Information Service.

#### NOTES:

- Peak solar panel power is obtained with full and direct exposure of sunlight. Atmospheric conditions determine the available power from the solar panel(s).
- The solar charge controller and associated solar panel is not designed to directly power the appliances and/or electric components installed in your motorhome. Its output is directly connected to the auxiliary battery (through an appropriately sized fuse), not to the 12 volt fuse panel.
- All 12-volt systems and components are either powered directly from the auxiliary batteries or through the converter, which receives input power from either the on-board generator or an external shore power service.
- The solar charger is powered directly from the auxiliary battery, therefore:
  - Turning the master battery switch OFF does not turn off the solar charge controller.
  - However, the master battery switch must be ON to monitor the RV-C type solar controller (turning ON the multiplex system touchscreen display).



Typical stand-alone, PWM 10 Amp Solar Charge Controller

## Solar Charging, 10 amp Controller

When installed, a 10 amp solar charging system includes 1 - 10 amp solar controller and 1 - 100-watt solar panel. This factory-installation is wired with 10 gauge wire from the solar panel to the solar controller and to the auxiliary battery. Due to controller capacity, **DO NOT** add additional solar panels to this system.

## Solar Charging, 30-amp Controller

Select TMC motorhomes are equipped with a 30-amp solar charging controller and system. These installations include 1 - 30-amp solar controller and 2 - 100-watt solar panels, wired in parallel (200 watts). Select TMC models can accept additional solar panels, with a total solar charging capacity of up to 500 watts. Inquire with your dealer about solar charging upgrades.

*NOTE: For operating and other important details regarding your solar panel and solar charge controller installed in your motorhome, refer to the manufacturer's owner's manuals included with TMC Owner's Packet.*

## Integrated Solar Charging Systems

*Applies to Solar Charging Systems with Multiplex Integration*

TMC motorhomes equipped with multiplex systems are factory-equipped with a solar charging system that is remotely controlled and monitored by the multiplex touchscreen panel. The solar charging system seamlessly integrates with the motorhome's multiplex control system, automatically providing an additional charging method for the motorhome's on-board house (auxiliary) battery(ies). The change from a stand-alone solar controller to multiplex integration began in model year 2023.

The auxiliary batteries continuously receive charging energy from the solar panel(s), regardless of whether the master battery switch is ON or OFF, unless the battery(ies) are disconnected at the terminals. Charging and battery condition is monitored on the multiplex touchscreen's solar menu. The remote solar charge controller senses the charging needs of the battery(ies), regulates the energy from the roof-mounted solar panel(s) to the battery(ies) (determined by type and charging profile of the auxiliary batteries installed), and sends system monitoring information to the multiplex touchscreen. Additionally, and via the multiplex touchscreen, users can select preset and custom operating parameters for the solar charging system.

When the controller senses that the auxiliary battery(ies) require charging, the controller cycles through multiple stages of internally programmed charging parameters. This multi-stage process is designed to rapidly re-charge the batteries, while protecting the batteries from damage due to over-charging and over-heating.

Depending on the model, the maximum input current rating of the remote solar controller is 10 or 30-amps, which, for safety

reasons, is designed to be a bit higher than the maximum (peak) amperage that the installed solar panel(s) can provide. The typical factory-installed solar panel is rated for 100 watts (peak), with some solar panels having a rating of 190 and 200 watts (peak power). Solar panel(s) installed on your motorhome may vary from these specifications; refer to your Owner's Packet for details.

The solar charge controller and associated solar panels are not designed to directly power the appliances and/or electric components installed in your motorhome. All 12-volt systems and components are either powered directly from the auxiliary batteries or by the converter, which receives input power from either the on-board generator or an external shore power source.

Operational and maintenance instructions from the manufacturer of both the solar controller and the solar panels are available on-line, through the TMC Owners Resource document service.



Integrated Solar Control. Illustration of Firefly touchscreen panel (above) and BMPro touchscreen panel (below). Although the menu screens have a different layout, both allow for monitoring solar charging and battery charge condition. With the Firefly system, solar control set-up is accessed either by a menu tab (configuration) or a set-up button. For the BMPro multiplex system, solar control set-up is accessed through the Settings Menu.



*NOTE: An optional 400 watt, factory-installed Solar Charging System may be available for your Class A motorhome. Check with your dealer about availability.*

## Solar Panels

### **⚠ WARNING**

**If not installed properly, a solar charging system can present electrical and fire hazards. Always ensure installations strictly follow all manufacturer's safety and installation guidelines when adding, changing, or modifying a solar charging system.**

Select TMC motorhomes are factory-equipped with 100-watt, 200-watt, or higher wattage solar panels. When installed, a solar panel and associated power controller becomes part of the auxiliary (house) battery charging system. Depending on the installed solar controller and other system parameters, solar panel charging systems may be expanded up to 500 watts of total solar energy.

The wattage rating of the installed solar panel(s) was derived by a standard test method that all solar panel manufacturers use. This rating represents the solar panel's peak output under ideal conditions of sunlight intensity, direction, cleanliness of the surface and temperature of the panel. There are many atmospheric factors and physical conditions that will affect the output of solar panels. On average, expected solar panel power output is approximately 75-80 percent of its peak rating.



Typical Roof-mounted Solar Panel

## Solar Prep

### **⚠ WARNING**

**NEVER install solar panels that have a higher current rating than the maximum input capacity of the solar controller installed in your motorhome.**

### **NOTICE**

**When installing a roof-mounted solar panel(s), ensure they are securely attached to mounting brackets and to structural components of the motorhome's roof. All mounting points and wiring ports need to be well sealed from moisture intrusion.**

TMC ESPEC Essential and other motorhome models may come pre-wired from the factory for a dealer or owner installed solar panel, along with a 10 Amp Solar Charging Controller. If your motorhome is not equipped with a factory-installed solar charging controller, it may be pre-wired for a dealer or owner-installed solar charging system. If so, there will be a Solar Prep Label affixed to the panel where a factory-installed solar controller is to be mounted.

All factory-installed solar preps include 10 gauge wire to the roof area, where a solar panel can be installed, along with 10 gauge wiring from the solar controller installation area to the battery compartment.

If the solar charging prep of your motorhome includes a solar controller, it is simply up to the user to add appropriately-sized (in wattage rating) solar panel(s) to the roof area. Then, connect the panels to the controller and the controller to the auxiliary battery(ies).



**IMPORTANT! ALWAYS be aware of the maximum current capacity of the solar controller and NEVER install solar panels of a higher current capacity than the rated input of the solar controller. Follow all solar panel and solar controller manufacturer's safety and installation guidelines when installing a solar charging system to your motorhome.**

#### NOTES:

Consult with your dealer or TMC Customer Care when installing a solar panel with your factory-installed solar controller.

- 10 Gauge stranded wire is rated for up to 300 watts of electrical energy. Where:
  - $\text{Wattage} = \text{Voltage} \times \text{Current}$ ;
  - $300 \text{ w} = 12\text{-volts} \times 25 \text{ amps}$ ;
  - DO NOT exceed the capacity of the solar charging wiring.
- A 10 amp solar controller has the maximum input current capacity from the solar panels of 100 -120 watts:
  - $120 \text{ w} = 12\text{-volts} \times 10 \text{ amps}$ ;
  - DO NOT exceed the input current capacity of the solar controller;
  - Ensure all installations are properly fuse protected.
- A 30-amp controller has the maximum input capacity from the solar panel array of:
  - $360 \text{ w} = 12\text{-volts} \times 30\text{-amps}$ ;
  - The system is wired with 10 gauge wire;
  - DO NOT exceed the input current capacity of the solar controller or the system wiring.

## Auxiliary Solar Panel Port

### ⚠ CAUTION

This auxiliary solar panel port is wired directly to the auxiliary battery(ies) and bypasses the solar controller. To ensure the auxiliary battery(ies) are protected from over-charging energy, solar panels connected through this port **MUST** include a built-in solar charge controller.

If additional solar panels are desired, always consider the input amperage limit of the solar controller. To prevent possible controller or charging system damage, **DO NOT** exceed the maximum input limit, in wattage, of total solar panel energy with any single or multiple solar panel array.

When connecting an auxiliary solar panel to the auxiliary solar panel port, always observe the polarity of an auxiliary solar panel and be sure the panel connector matches the polarity of the solar panel port.

As a convenient means of increasing solar charging capacity, an auxiliary solar panel port is provided on select TMC Class A and Class C motorhomes. The port may be located on either the left or right side. A user-supplied portable solar panel can be plugged into the auxiliary solar panel port to augment the roof-mounted solar panel's energy output. Refer to the manufacturer's information about the total input capacity in watts of the installed solar charge controller.



**IMPORTANT! Never exceed the input capacity of the solar charge controller with the total amount of solar energy (in watts) of the connected solar panels.**

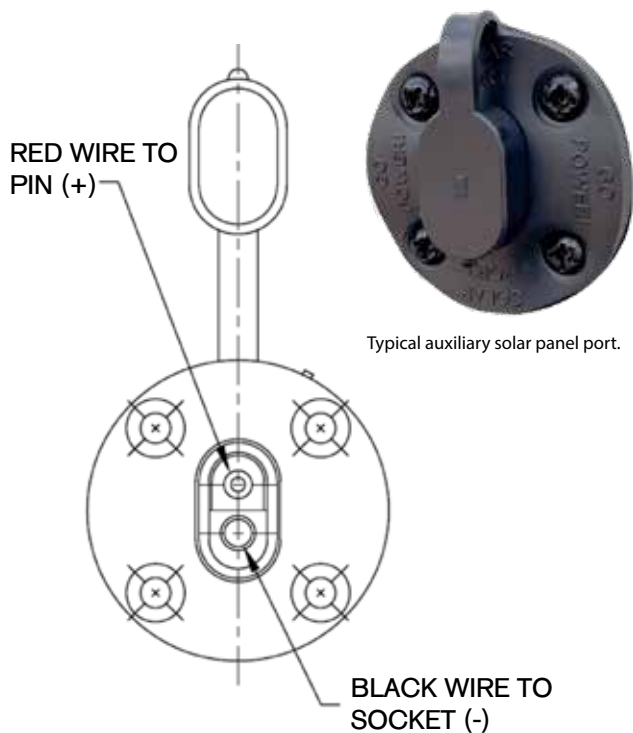

## Lithium-Ion Auxiliary Battery Installations, Class C

*DISCLAIMER NOTE: Auxiliary batteries and 12 volt power systems are subject to change without notice and Thor Motor Coach reserves the right to make changes, component substitutions, and improvements to its motorhomes built and/or sold at any time without incurring any obligations to make the same or similar changes on vehicles previously built and/or sold by TMC. The battery system installed in your motorhome may differ slightly or significantly with the descriptions and information contained in this section.*

Select TMC Class C motorhomes are equipped with Lithium-Ion battery(ies), replacing the typical AGM, flooded, or lead-acid auxiliary (house) battery. There are important differences between an electrical system with lithium auxiliary batteries as compared to an electrical system with standard lead-acid auxiliary batteries:

- The typical Li-Ion battery installation consists of 1- 100 Ah Lithium-Ion (LiFePO4) auxiliary (house) battery.
- Installations may include a separate battery monitor.
- Installations include a DC-DC charger, which allows battery charging while the vehicle's engine is running.
- The factory-installed solar charging system augments battery charging while traveling.

### Lithium-Ion Battery Safety

#### **WARNING**

- **There is a dangerous potential of exhaust gases entering the motorhome whenever the vehicle is parked and the engine is running.**
- **Avoid inhaling exhaust gases as they contain carbon monoxide, which is a toxic gas that is colorless and odorless.**
- **Before using the vehicle's engine to charge battery(ies), ensure the vehicle is parked in an open area and that the vehicle's exhaust system is free of obstructions.**
- **DO NOT operate the vehicle's engine if the vehicle is parked in an enclosed building or confined space.**
- **Test the CO/LP detector and ensure it is operational.**
- **NEVER sleep or allow others to sleep in a parked motorhome while the engine is running.**

- **NEVER open the connector lid on top of the battery. Doing so may cause damage to the printed circuit board.**
- **Review and follow all available product safety, operational, and disposal information available from the battery manufacturer.**

#### **WARNING**

##### **NEVER SIMULTANEOUSLY CHARGE A BATTERY FROM SHORE POWER AND THE ENGINE ALTERNATOR:**

- **Excessive charging energy will result in battery damage.**
- **Contact the manufacturer for recommended charging specifications and safety guidelines.**

#### **WARNING**

**Short circuits, too deep discharges, and too high charge currents will damage the battery and may result in fire, explosion, electric shock, or release of toxic gas. Always install an external safety relay!**

##### **NEVER CHARGE A BATTERY:**

- **After it was discharged below the Discharge Cut-off Voltage.**
- **When the battery is damaged.**
- **When the battery was overcharged.**

#### **NOTICE**

- **The voltage range of a Lithium-Ion battery (12.0-14.6V) is greater than lead-acid batteries. Be aware that these voltages could exceed the permitted voltages of the connected electrical devices.**
- **The battery(ies) installed in your motorhome are ready for operation. If battery maintenance or replacement is required, FOLLOW THE MANUFACTURER'S INSTRUCTIONS for battery installation, preparation, and disposal.**
- **Standard battery chargers may not provide enough voltage to fully charge Lithium-Ion batteries. Ensure battery charger can deliver and is set to a Lithium-Ion battery charging profile.**
- **The components of the Re(Li)able battery power system are designed and manufactured with high quality materials and components, which can be recycled and reused. Follow local safe disposal practices—NEVER dispose battery system components with normal household waste. Always dispose components through an authorized waste management facility.**

## Basic System Operation

Operation of the lithium auxiliary battery system is similar to a typical lead-acid RV auxiliary battery system:



**IMPORTANT! DO NOT OPERATE THE GENERATOR WHILE SLEEPING. THE USE OF A GENERATOR PRESENTS THE POSSIBILITY OF CARBON MONOXIDE GAS ENTERING THE MOTORHOME. ENSURE THE LP/CO DETECTOR IS OPERATIONAL.**

- When entering the motorhome, turn ON the rotary master battery switch. Doing so powers the 12-volt system, allowing the use of lights, leveling and stabilizing systems, slideouts, awnings, and 12-volt DC devices. The master battery switch must also be ON to power the dash radio and back-up monitor and to power the combination LP/CO detector.
- When parked and connected to shore power, the master battery switch also must be ON in order to allow full operation of all electrical functions of the motorhome.
- Turn OFF the master battery switch whenever leaving the motorhome for an extended time period. Doing so will prevent unnecessary battery drain. However, your motorhome may be equipped with an electric-only refrigerator (12-volt DC or 120-volt AC). If you need to keep the refrigerator running while parked and NOT connected to shore power, keep the master battery switch ON, while ensuring other 12-volt DC and 120-volt AC devices remain OFF.
- Also, if your motorhome is equipped with a gas/electric refrigerator, operating the refrigerator on gas will reduce battery consumption, however, the master battery switch must remain ON in order to provide power to the 12-volt electrical control circuits of the refrigerator.
- When not connected to shore power, use the on-board generator to supply the electrical demands of the motorhome.
- Use the battery monitor to monitor the condition of the auxiliary battery(ies).
- It is good practice to keep the solar charge controller ON, providing solar charging to the auxiliary battery(ies).
- The inverter (if equipped) is typically wired directly to the auxiliary battery (through a 100 amp circuit breaker. The inverter is designed to power a limited amount of 120-volt AC devices of the motorhome.

### NOTES:

- *The typical inverter installed in Class C motorhomes has the capacity of 1,000 watts-enough for operating the refrigerator (120 VAC compressor type), but not enough power to operate the roof air conditioner.*

- *Your motorhome may be equipped with an Automatic Generator Start (AGS) device, which will start and stop the generator depending on the energy demands of the motorhome. Become familiar with its safe use.*
- *Due to a typically lower cranking amperage of li-ion battery(ies) (compared to AGM) the Emergency Start feature is usually not available on TMC Class C motorhomes equipped with a Lithium-Ion auxiliary battery.*

## Battery Charging Sources

There are three battery charging sources designed into the electrical system:

- AC-DC Converter
- Auxiliary Battery Charger
- Solar Charging System

When connected to shore power, part of the incoming 120-volts AC is converted to 12-volts DC by the converter, which uses part of this energy for battery charging (the converter provides the proper charge profile for lithium batteries).

While the vehicle's engine is running, the auxiliary battery charger is receiving operating energy from the chassis alternator, and in-turn, providing up to 40 amps of charging current to the auxiliary battery(ies). Charging energy is also being supplied by the solar charging system, whether the engine is running or off. When the engine is running, solar energy is supplied first to the chassis battery, to ensure it remains charged for vehicle starting. Then, when the auxiliary battery charger senses that the chassis battery is fully charged, solar charge energy is re-directed to the auxiliary battery(ies). When the engine is OFF, solar charging is passed through the DC-DC auxiliary battery charger and to the auxiliary battery(ies). Both the auxiliary battery charger and the solar charge controller are programmed to provide the proper charge profile for lithium batteries.

Solar charging energy is available (depending on weather and daylight conditions) whenever the solar charge controller is ON. It takes a small amount of operating energy directly from the auxiliary battery, therefore, is not dependent on the ON/OFF condition of the master battery switch. Solar-generated power is fed from the rooftop solar panel to the auxiliary battery(ies) through the solar controller. Up to 10 amps of charging energy is available (during ideal conditions and dependent on the output rating of the solar panel) from the solar charging system.

The solar charge system can always be used to keep a float charge on the auxiliary battery(ies), ensuring the auxiliary battery(ies) do not go 'dead' during periods of inactivity.

The Solar Charge Controller is typically a stand-alone unit, mounted near the entrance of the motorhome. In motorhomes with a multiplex wiring system, the solar controller is remotely controlled through the main multiplex control panel.

NOTE: The experience you gain from using the electrical system and installed lithium battery(ies) is the best determination of how long your charged batteries will supply power for your particular electrical demands before requiring recharging.

## Battery Monitoring

Monitoring the energy stored in the auxiliary battery(ies) of your Class B motorhome is accomplished by a factory-installed battery monitor; typically, the Go Power GP-BMK-25 Battery Monitor (or a comparable unit). This device allows the user to monitor important battery parameters, such as:

- State of Charge (SOC)
- Capacity (as a percentage of available output)
- Voltage
- Current



- |  |                                   |
|--|-----------------------------------|
| 1 Capacity of a fully charged battery pack | 7 Enter Project Line/Select Digit |
| 2 Charge/Discharge Indicator               | 8 Present Power                   |
| 3 Capacity Percentage                      | 9 Remaining Time                  |
| 4 Quit Settings/Quit Project               | 10 Present Current                |
| 5 Previous Row (Setting Value +1)          | 11 Present Voltage                |
| 6 Next Row (Setting Value -1)              | 12 Dynamic Indication             |

NOTE: If you change the factory-installed battery(ies) for a different type or amp-hour (AH) capacity, you must change the settings parameters of the battery monitor to match the new battery(ies) characteristics.

## Lithium-Ion Auxiliary Battery Charging

### ⚠ WARNING

- There is a dangerous potential of exhaust gases entering the motorhome whenever the vehicle is parked and the engine is running.
- Avoid inhaling exhaust gases as they contain carbon monoxide, which is a toxic gas that is colorless and odorless.
- Before using a stationary vehicle's engine for battery charging, ensure the vehicle is parked in an open area and that the vehicle's exhaust system is free of obstructions.
- DO NOT operate the vehicle's engine if the vehicle is parked in an enclosed building or confined space.
- Test the CO/LP detector and ensure it is operational.
- NEVER sleep or allow others to sleep in a parked motorhome while the engine is running.
- DO NOT operate the vehicle's engine if connected to shore power.
- When charging an auxiliary battery with a charger, power source, or method, whether part of the motorhome's original factory-installed electrical system or an aftermarket device, make sure to follow all battery and charger manufacturer's safety instructions.

### ⚠ WARNING

**NEVER SIMULTANEOUSLY CHARGE A BATTERY FROM SHORE POWER AND THE ENGINE ALTERNATOR:**

- Excessive charging energy will result in battery damage.
- Contact the manufacturer for recommended charging specifications and safety guidelines.

It is important to keep the auxiliary battery(ies) in a condition of full or near-full charge. Doing so will ensure 12-volt DC energy is available when needed. Battery charging is accomplished by:

- The auxiliary battery charger, which is powered by the chassis alternator when the vehicle's engine is running;
- Automatic charging through the converter, when the engine is stopped and using shore power or generator;
- The solar charging system (equipped as standard, optional, or customer installed).

Take time to turn off all lights or other 12-volt accessories when not in use. Connect the motorhome to a 120-volt AC shore power source or run the generator whenever possible. Doing so will keep the auxiliary batteries charged.

NOTE: The master battery switch must be ON to charge the auxiliary battery(ies) by shore power (converter).

## Charging by the Vehicle's Alternator

### CAUTION

- **There may be times when the vehicle is either in motion or parked (with the engine running) and it is desirable to operate the generator so that 120-volt AC appliances, such as the roof air conditioner, can be used while traveling and not plugged into a shore power source. During these circumstances, the auxiliary battery will receive charging energy from both the auxiliary battery charger (via the engine running) and the converter (by the generator running).**
- **Given that the auxiliary battery charger can deliver up to 40 amps of charging current, AND the converter can deliver up to 55 amps of charging current, the auxiliary battery could potentially receive up to 95 amps of charging current. Although this is under the battery manufacturer's maximum charge current of 100 amps, caution should be observed so that the auxiliary battery does receive over-charging energy.**
- **You may elect to turn OFF the Converter Circuit Breaker, located in the Main Fuse Panel. Just remember to turn the converter circuit breaker back ON when not operating the generator while the vehicle's engine is running.**

The motorhome's electrical system is wired so that when the vehicle's engine is running, and the chassis alternator is properly operating, charging voltage is supplied to the chassis battery, while also supplying operating voltage to the on-board DC to DC auxiliary battery charger.

The dual-input DC to DC battery charger takes input energy from the vehicle's alternator, along with the solar charging system, and provides charging energy (up to 40 amps), charging monitoring, and charging regulation to the auxiliary battery; thus ensuring that the Lithium-Ion battery(ies) are properly charged and not overcharged while the vehicle's engine is running.

If needed, auxiliary battery charging can be accomplished by starting and running the vehicle's engine while parked.

#### Approximate charging times:

The time it will take to charge an alternate battery by the vehicle's alternator and auxiliary DC-DC charger is dependent on several factors; the State of Charge (SOC) of the battery, whether there is a load on the battery, i.e., lights or appliance turned ON, ambient and battery temperature, age of batteries, etc.

However, at normal engine idle speed, vehicle's alternator and DC-DC electronic charger will deliver approximately 40 amps of charging energy. For a fully depleted 100 Ah lithium battery, it would take approximately 2.5 hours to fully charge the battery (MB Sprinter-based chassis ONLY - See Special Section on Elevated Idle Speed for Ford Transit-based motorhomes).

#### Tips for battery charging:

Use good judgment when using an idling engine to charge the auxiliary battery:



**IMPORTANT! ALWAYS OBSERVE EXTREME CAUTION WHENEVER PARKED AND THE VEHICLE'S ENGINE IS RUNNING DUE TO THE POSSIBILITY OF EXHAUST GASES ENTERING THE VEHICLE (see Warning at the beginning of this section).**

- Extended periods of engine idling presents certain wear to the engine and engine components.
- Always take advantage of the factory installed solar charging system; doing so can reduce charging times. The on-board solar panel and charging controller can deliver up to 10 amps of additional charging energy, which could reduce charging times by 20 percent.
- Use shore power and/or the generator for charging whenever available. When connected to shore power or operating the on-board generator, as high as 55 amps of battery charging energy is supplied by the converter. Add an additional 10 amps from the solar charging system, battery charging could be accomplished in as little as 1.5 hours (100 Ah ÷ 65 A = 1.5 hours).
- When driving the vehicle, always keep the master battery switch ON. This allows auxiliary battery charging from the vehicle while in motion.
- Use appliances and electric devices prudently. Doing so will help reduce battery system energy consumption.

NOTE: Additional and important information pertaining to the Lithium-Ion battery system installed in your Class C TMC motorhome is contained in the TMC Lithium Battery Systems Guide, available through your on-line TMC Owners Resource account.

## Auxiliary Battery Charger: Redarc BCDC1240D

The Redarc battery charger is installed and used for auxiliary battery charging whenever the vehicle's engine is running (in-motion or parked). The battery charger is a dual-input device, being supplied operating voltage either by the vehicle's alternator or by the solar charging system. The charger then provides and appropriate charging profile (depending on battery type) to the auxiliary battery(ies) whenever low battery voltage is detected.

The Redarc battery charger is a green device, meaning that it will prioritize solar charging energy whenever adequate solar power is sensed at the charger's input. Then, if needed, supplementing charging power from the vehicle's alternator to effectively meet auxiliary battery charging energy requirements.

### Specifications:

BCDC1240D	
Input Voltage Range	9 - 32V
Output Current	40A
Output Battery	12V
No Load Current	<100mA
Standby Current	<8mA
Recommended 12V Input Fuse	60A
Recommended Output Fuse	60A
Output Power	600W
MPPT Solar Regulator	Yes
Solar Switch ON Voltage	9V
Solar Range	9 - 32V
Ambient Temperature	-14° to 175°F (-10° to 80°C)
Dimensions (D x W x H)	6.5x4.7x1.46" (165x120x37mm)
Weight	2 lb 3 oz (1kg)



Redarc BCDC1240D Charger

## Additional Lithium-Ion System information:

- The rotary master battery switch should be turned OFF whenever the motorhome is not being used.
- The battery(ies) shut down (enter 'sleep' mode) when their voltage drops below approximately 10 volts, or their SOC drops to between 0% and 10%. To re-awake, a charging source must be provided.
- Re-charge the battery(ies) by connecting to a shore power source or by operating the vehicle's engine, charging via the vehicle's alternator and DC-DC auxiliary charger. Remember, to start charging a discharged battery (less than 10% SOC), the Emergency Start Switch may need to be pressed for several seconds (while the engine is running). The Emergency Start Switch may also need to be momentarily pressed (10-15 seconds) when charging depleted batteries via shore power.
- For efficient cold weather operation, the batter(ies) has internal heaters. Internal heaters only turn ON when a charging source is present.
- Batteries should NOT be charged if the ambient temperature is above 113° F (45° C). The alternator regulator turns OFF vehicle charging at this temperature. Charging by shore power or solar power is not automatically limited by temperature. Users should prevent charging by these methods when ambient temperatures are extremely high.
- A severely cold battery could be permanently damaged by high or excessive charging current. This is why many lithium batteries have internal heating pads. If possible, move a severely cold battery to a warm environment (at least 32°F (0°C) and let it accumulate to this temperature before charging.
- The solar charging system can be used to maintain a float charge on the battery(ies) while in storage. However, charging energy is dependent on atmospheric conditions and may not be dependable for long-term battery charge maintenance.
- When the storage period ends and the Lithium-Ion battery system is placed back into service:
  - Remove the 15 amp, 3 prong standard household adapter from the shore power cord.
  - Return circuit breakers to their normal operation position (ON).
- Contact the battery manufacturer if you have any questions regarding charging, maintenance, or long-term storage.

## Ford Transit Chassis Idle Speed Control

**NOTICE**

**— FORD TRANSIT CLASS C CHASSIS ONLY! —  
BATTERY CHARGING VIA THE AUXILIARY  
ALTERNATOR**

**Under normal driving conditions, the auxiliary alternator will provide adequate charging energy (voltage) to recharge the power system's Lithium-Ion batteries (via the auxiliary battery charger). However, when parked and with a warm engine running, the normal low engine idle speed may not allow the vehicle's alternator to generate adequate charging energy for both the vehicle battery and the auxiliary charging system.**

**Therefore, when the vehicle is parked, and it becomes necessary to operate the engine to charge the lithium battery(ies), press the ELEVATED IDLE SPEED CONTROL SWITCH (or SEIC Switch), mounted on the vehicle's dash panel. Doing so, increases the engine idle speed, thus allowing the auxiliary alternator to generate adequate energy to charge the lithium batteries.**

**NOTE: Elevated idle will not engage until all pre-operating parameters are met. See list below.**

Ford Transit-based TMC Class C Motorhomes (Compass and Gemini models) that are equipped with a lithium auxiliary battery, may also be equipped with a manual (driver activated) engine Elevated Idle Speed Control Switch.

The Elevated Idle Speed Control Switch provides for the selection of three engine idle speeds:

- **Elevated:** Approximately 850 RPM
- **High Idle:** Approximately 1,500 RPM
- **OFF:** Normal warm engine idle is approximately 650 RPM (center switch position)

To activate Elevated or High Idle, the following pre-operating parameters must be met:

1. Vehicle speed is 0 MPH (stationary).
2. Vehicle transmission is in PARK.
3. Parking brake is applied.
4. Foot is off the service brake.
5. Foot is off the accelerator pedal.



Ford Transit Idle Speed Control Switch.

6. Engine is running and is at a stable base idle speed.
7. Engine Coolant Temperature (ECT) 40°F minimum.

Operating the Elevated Idle Control:

1. Start the vehicle's engine and allow a brief warm-up.
2. Ensure all pre-operating parameters are met (listed above). The Elevated Idle Control will **NOT** engage until the engine reaches normal low idle speed.
3. Press either the **Elevated Idle** or **High Idle** switch position. The LED on the switch panel will light, indicating elevated idle speed system activation.

The engine's RPM will noticeably increase, allowing the auxiliary alternator to generate enough energy to charge the Lithium-Ion battery pack(s).

**NOTE:** Faster charging will be realized with the High Idle position.

4. Monitor the battery condition (State of Charge, or SOC) on the battery monitor.
5. When the Lithium-Ion battery pack has reached an adequate state of charge, turn OFF the vehicle's engine. With the engine OFF, the idle speed control will automatically reset to normal operation.

Conditions that will deactivate High Idle Control:

The Elevated Idle Control System will automatically deactivate whenever any of the following conditions is encountered:

- The Parking Brake is disengaged.
- The Service Brake is depressed.
- The vehicle's transmission is taken out of **PARK**.
- The engine management system senses too high of a;
  - Engine Coolant Temperature, or;
  - Transmission Oil Temperature, or;
  - Catalytic Converter Temperature.

*NOTE: If a system deactivation event occurs or the system fails to activate, the engine must be allowed reach a stable and normal idle speed before re-activation can occur. This usually takes 15-30 seconds. Place the Elevated Idle Switch in the OFF position, wait 30 seconds, make sure all the pre-operating vehicle parameters are met, then re-engage the Elevated Idle Control.*

**DISCLAIMER:** Thor Motor Coach reserves the right to change battery suppliers, battery type, battery power rating, or any battery system specifications or battery system components without prior notification or obligation to modify, update or retro-fit prior production or special-order vehicles.

## 120-volt Electrical System

Power for the 120-volt AC electrical devices installed in your motorhome is supplied either by the on-board generator or by connecting to an exterior power source, commonly known as Shore Power.

If equipped, limited 120-volt AC power is provided by the inverter, which converts 12-volt DC power from the auxiliary battery(ies) to 120-volts AC. The inverter is not designed to power the entire 120-volt system and when used, care must be exercised so that overloading the inverter and/or depleting the battery(ies) is avoided.

### Shoreline Power

#### **DANGER**

**CONNECTING THE SHORE CORD TO A NON-GROUNDED OR IMPROPERLY GROUNDED POWER SOURCE CAN RESULT IN DANGEROUS AND POSSIBLY FATAL ELECTRIC SHOCK.**

Due to the potential danger in failing to heed this warning, the motorhome manufacturer cannot be responsible should damage, injury, or death result from failure to connect the power cord to a properly grounded power source.

#### **WARNING**

The campsite 120-volt power receptacle(s) should always be tested for proper functionality prior to connecting your motorhome's shoreline power cord to it. **DO NOT** hook up the shoreline power cord to any receptacle until you have verified proper polarity and grounding.

**DO NOT** plug the shoreline power cord into a campsite receptacle:

- That has reverse polarity;
- With non-functioning ground circuits;
- That shows outward signs of heat or other damage.

Doing so may result in property damage or severe injury. Damage or injury resulting from a connection to a malfunctioning or improperly wired power source is not covered by warranty.

It is the responsibility of the owner of the electrical service stand to ensure that the receptacles are properly wired and grounded. Reverse polarity and/or improper grounding of your motorhome can cause equipment damage, personal injury, or death.

#### **WARNING**

- **Make sure the circuit breakers at the electrical power source are in the OFF position before connecting or disconnecting the shoreline power cord.**
- **The shoreline power cord must be fully extended when in use and not left coiled in a storage compartment or on the ground.**
- **DO NOT use cheater plugs, adapters, or extension cords to reconfigure incoming alternating current (AC) power or break the continuity of the circuit connected to the grounding pin.**
- **DO NOT connect the shoreline power cord to an outlet that is not grounded or adapt the power cord plug to connect it to a receptacle for which it is not designed.**
- **DO NOT remove the grounding pin to connect to a non-grounded receptacle. Removal of the ground pin disables an important safety feature designed to prevent electrocution hazards.**
- **DO NOT lengthen the shoreline power cord with an extension cord. Use of an improper extension cord will cause overheating of the cord as well as potentially causing failure of on-board electrical equipment.**
- **Damaged shore power cords are an electrical shock hazard. Inspect cords for damaged or missing contact pins, cut or damaged insulation, and frayed wires. Replace damaged shore power cords immediately.**

#### **CAUTION**

- It is strongly advisable to test the wiring of any external power source **BEFORE** connecting your motorhome. Along with a proper ground, the 120/220 volt AC source must have properly wired neutral and hot terminals.

A digital multimeter, available from RV suppliers and dealers, will enable you to easily check the AC source wiring. Follow the instructions provided by the multimeter manufacturer.

- If a problem with the external power source is found, **CONTACT THE CAMPSITE MANAGER** for repairs. **DO NOT** attempt repairs to the site power source and **DO NOT** connect your motorhome to the site power source until it is determined safe to do so.

### 30-amp, 120-volt Shoreline Power Cord

#### **⚠ WARNING**

**MOTORHOMES THAT ARE FACTORY-EQUIPPED WITH A 30-AMP ELECTRICAL SERVICE SHOULD NEVER BE CONNECTED TO A POWER SOURCE THAT WILL PROVIDE MORE THAN 120-VOLTS AC.**

Although the 3-prong, 30-amp RV connectors look similar to 240-volt AC connectors found in residential homes (electrical dryers, stoves, etc.), the 30-amp RV power service is designed for 120-volts AC only.

**Failure to follow this power requirement will result in severe damage to appliances and electrical devices.**

Depending on the model, TMC motorhomes may be equipped with a 30-amp electrical service and a 30 amp shoreline power cord, which is used to attach the motorhome to a grounded 120-125 volt AC, 30-amp external power source. Always turn OFF the main power switch or circuit breaker of the shore power electrical outlet before connecting or disconnecting the shoreline power cord. This will eliminate arcing of electrical contacts and reduce the potential of electrical shock. Please strictly follow all electrical-related safety labels affixed to your motorhome.

**⚠ WARNING**

**THIS CONNECTION IS FOR 110-125-VOLT AC, 60 HZ, 30 AMPERE SUPPLY. DO NOT EXCEED CIRCUIT RATING. EXCEEDING THE CIRCUIT RATING MAY CAUSE A FIRE AND RESULT IN DEATH OR SERIOUS INJURY.**

A Warning Label, similar to the one shown here, is affixed on your motorhome, near the 30-amp shoreline cord inlet.



4-prong 50-amp shore power cord (left) and 3-prong 30-amp shore power cord (right)

Typical Camp-ground electrical service stand. This illustration shows 50-amp, 30-amp, and 15-20 amp outlets, along with corresponding circuit breakers.



### 50-amp, 240-volt Shoreline Power Cord

#### **⚠ WARNING**

**MOTORHOMES THAT ARE FACTORY-EQUIPPED WITH A 50-AMP ELECTRICAL SERVICE ARE DESIGNED TO BE CONNECTED TO A 50-AMP EXTERNAL POWER SOURCE, WHICH PROVIDES A COMBINED TOTAL OF 240-VOLTS AC.**

The 240-volts comes from two 120-volt power legs (measured to neutral or ground and 180 degrees out of phase). This power service provides 100 amps total to the motorhome. The motorhome should NEVER be connected to a power source that supplies voltages that are more than 120-volts on either incoming power leg.

**Failure to follow this power requirement will result in severe damage to appliances and electrical devices.**

Depending on the model, TMC motorhomes may be equipped with a 50-amp electrical service and a 50-amp shoreline power cord, which is used to attach the motorhome to a grounded 50-amp external power source. Similar to the incoming power service to your house, the incoming voltage of a 50-amp service is 240-volts AC, consisting of two 120-volts AC power legs. At the circuit breaker panel of the Power Load Center, the 2 power legs are split, each feeding 120-volts AC power to separate sections of the fuse panel.

Always turn OFF the main power switch or circuit breaker of the external power source when connecting or disconnecting the shoreline power cord. This will eliminate arcing of electrical contacts and reduce the potential of electrical shock.

*NOTE: A 50-amp shore power source supplies 240-volts AC incoming power; 120 VAC on each of the two power legs. The Power Load Center is wired to split the incoming 240 VAC into two 120 VAC branches for the motorhome's electrical circuits.*

**⚠ WARNING**

**THIS CONNECTION IS FOR 208Y/120-VOLT or 120/240-VOLT AC, 3-POLE, 4-WIRE, 60 HZ, 50 AMPERE SUPPLY. DO NOT EXCEED CIRCUIT RATING. EXCEEDING THE CIRCUIT RATING MAY CAUSE A FIRE AND RESULT IN DEATH OR SERIOUS INJURY.**

A Warning Label, similar to the one shown here, is affixed on your motorhome, near the 50-amp shoreline power cord inlet.

*NOTE: The use of a surge protection device on the incoming shore power source is highly recommended (not supplied by TMC). Check with your RV dealer about surge protecting devices and operational details.*

## Powered Shoreline Cord Reel

Select TMC motorhomes are equipped with a powered shoreline cord reel. 50-amp shore power cords have large diameter wires and, due to their size and weight, can be difficult to handle. A powered cord reel facilitates retracting the shoreline cord when not in use.

The motor of the powered cord reel operates on 12-volts DC from the auxiliary (house) batteries. Therefore, the master battery switch must be ON in order to operate the powered cord reel.



50-amp shore power cord attached to an electrical-powered reel.

*NOTE: Shoreline power cords may be affixed to the motorhome or have connectors on both ends. Connect the pronged (or male) end to the shore power cord to the external electrical service, and the socket (or female) end to the motorhome's electrical connection port.*

## Connecting to an External Power Source

Inquire with the campsite owner or manager if they provide the electrical service your motorhome requires. It is always advisable to ensure the external electrical source is properly wired and grounded before connecting your motorhome. If the external electrical



Typical shoreline power cord connection port

source is confirmed to be appropriate for your motorhome's electrical system, follow this electrical hook-up procedure:

1. Locate the load center inside your motorhome and turn OFF the main AC circuit breakers. Some panels will have two main circuit breakers.
2. Carefully extend the entire length of the shoreline power cord (approximately 35 feet) from the electric cable port on the motorhome to the external power source.
3. Ensure the circuit breaker(s) at the external power source are OFF.
4. Connect the shore power cord to the receptacle on the motorhome. If the connector has a locking ring, carefully engage the threads until snug. Some connector designs may require a slight twist after insertion, while some power cords are wired directly to the motorhome, making this step unnecessary.
5. Plug the shoreline power cord into either the 30-amp or 50-amp external power receptacle, matching the power requirements and power cord connector of your motorhome. Be sure all the connector prongs are properly and completely inserted into the power source receptacle.
6. Turn ON the circuit breaker at the external power source.
7. Turn ON the main circuit breaker(s) at the motorhome's load center.

When you are ready to leave the campsite, reverse the shoreline power cord connection process. Use care to prevent damaging the electrical connection pins when connecting or disconnecting the shoreline power cord. Grasp the plug to remove the shoreline power cord from the outlet; DO NOT unplug it by pulling on the cord.



Attach the shore power cord to the motorhome by slipping the connector over the pins of the connection port. Give the connector a slight twist to the right, then spin-on the locking ring to secure the power cord to the motorhome.

**Need New Photo**

## Shore Power Wiring Configuration

For safe electrical power for your motorhome's electrical system, it is important that the external power source is correctly wired. If the shore power source is incorrectly wired, it is possible that the chassis frame and metal objects could become energized. It is also extremely important that the shore power source is properly grounded, thus protecting from the physical hazards of electrical shock.

Below are illustrations of the proper wiring for the 50-amp and 30-amp shore power cords and their corresponding power receptacles. Please talk to the campground's maintenance personnel if you have any questions or concerns regarding the wiring of the campground's electrical hook-ups.

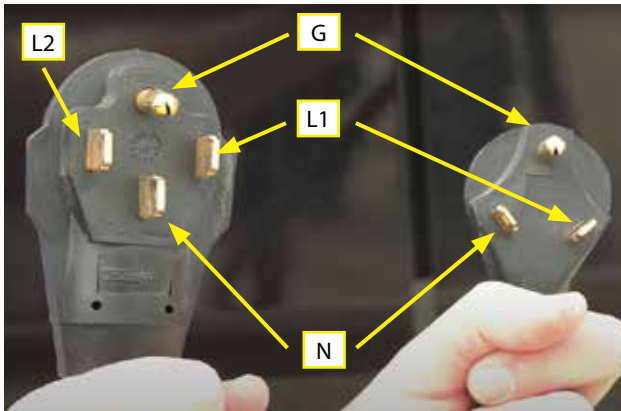

G = Ground    L1 = Leg 1 (120 VAC measured to neutral or ground)  
 N = Neutral    L2 = Leg 2 (120 VAC measured to neutral or ground. L1  
 and L2 are 180 degrees out of phase)

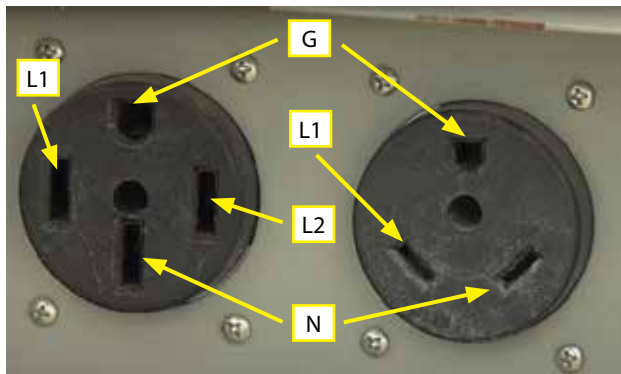

50-amp, 240-volt  
 Electrical Service  
 Receptacle

30-amp, 120-volt  
 Electrical Service  
 Receptacle

## Shoreline Cord Plug Adapters

### **⚠ WARNING**

**USE EXTREME CAUTION WHENEVER ADAPTING SHORE POWER CORDS TO AN UN-MATCHED ELECTRICAL SERVICE.**

- 50-AMP SHORE POWER CORD TO A 30-AMP SERVICE.
- 50 OR 30-AMP SHORE POWER CORD TO A 15-20 AMP SERVICE.

**THE SIGNIFICANTLY REDUCED AMOUNT OF AVAILABLE INCOMING POWER COULD DAMAGE ELECTRICAL MOTORS, COMPRESSORS, AND OTHER DEVICES.**

### **⚠ WARNING**

**NEVER ADAPT A 30-AMP SHORE POWER CORD TO A 50-AMP EXTERNAL POWER SERVICE.**

**SEVERE ELECTRICAL OVERLOAD TO THE SHORE POWER CORD AND/OR THE MOTORHOME'S ELECTRICAL SYSTEM COMPONENTS COULD CAUSE ELECTRICAL FIRES OR OTHER DAMAGE.**

### **⚠ CAUTION**

**REDUCE POWER LOADS WHENEVER ADAPTING A LARGER AMPERAGE SHORE POWER CORD TO A SMALLER SHORE POWER SOURCE.**

**DO NOT USE POWER-CONSUMING ITEMS, SUCH AS AIR CONDITIONERS, MICROWAVE OVENS, ETC.**

## **NOTICE**

If you are adapting from a 50-amp electrical system to a 30-amp power source, your motorhome will **NOT** be supplied with the total electrical power required to operate all on-board devices simultaneously. A 30-amp, 120-volt service can only supply up to 3,600 watts of power (watts = amps x volts), where a 50-amp, 240-volt service can supply up to 12,000 watts of power, or 3 times the power compared to a 30-amp service.

Only do so as a **TEMPORARY** means of supplying limited electrical power to your motorhome. **DO NOT** use high-demand electrical devices, such as air conditioners and kitchen appliances. Electrical overloads can easily happen and could cause damage to the electrical devices of your motorhome.

Plug adapters are available to allow connecting a 4-prong, 50-amp shoreline power cord to a 3-prong, 30-amp shore power service, and a 3-prong, 30-amp shore power cord to a standard, 3-prong household electrical plug.

Need New  
Photos



Power cord adapters are available in several styles and configurations. Only use adapters when absolutely necessary and on a temporary basis. Always be aware that the use of adapters usually restricts the available power to the motorhome.

Using a 120-volt, 15-20 amp power adapter:

Use 120-volt, 15-10 amp adapters only for extremely limited use, such as powering a few internal lights, powering a refrigerator, or providing charging energy for auxiliary batteries when the motorhome is in storage.

*NOTE: In limited shore power situations such as described here, when possible, it is a better solution to use the motorhome's generator to supply electrical power.*

## Trickle Charging Batteries During Storage

The shore power cord and the motorhome's converter can be used to keep the auxiliary batteries charged during storage.

1. Use a plug adapter to convert the shore power plug to a standard, 3-prong household outlet.
2. At the motorhome's circuit breaker panel, turn ON the Main Circuit breaker(s) and the Converter circuit breaker. Turn OFF all other circuit breakers.

3. Plug in the shore power cord to the household outlet.
4. Turn ON the master battery switch.
5. Ensure all interior lights and 12-volt devices are OFF or disconnected from the power source.

*NOTE: Batteries in Class A Diesel Pushers with inverter/chargers can be charged without the master battery switch ON.*

## Electrical Fault Protection

TMC motorhomes are equipped with transfer switches that provide reverse polarity and open ground protection. If there is an electrical fault with the shore power source or generator power, a fault warning message will be displayed either on the multiplex main panel screen or an indicator on the monitor panel and power will not be passed through the transfer switch to the motorhome.

If a ground or reverse polarity fault is detected, the shore power source or generator must be repaired by a qualified technician or electrician.

## Shore Power Cord Maintenance

Inspect the shoreline power cord for damaged or missing contact pins, cuts, cracks, and worn insulation. Damaged shore power cords are an electrical shock hazard. For your own safety and to maintain the integrity of the electrical system, replace damaged shore power cords immediately.



**IMPORTANT: Always respect electrical energy and NEVER use an electrical device that is faulty or damaged. Only use an electrical device or accessory for its designed purpose.**

*NOTE: Travel with a circuit tester or a digital multimeter in your tool bag. This will allow testing shore power service and help diagnose power-related issues.*

## Power and Electrical Accessories

Your dealer is the best source for advice and recommendations for shore power accessories, such as power plug adapters, extensions, circuit testers, surge protectors and other useful devices pertaining to shore power and the electrical system of your motorhome.

## Generator

### **⚠ DANGER**

**OPERATING THE GENERATOR CREATES EXHAUST GASES THAT CONTAIN CARBON MONOXIDE. CARBON MONOXIDE IS POISONOUS AND CAN CAUSE UNCONSCIOUSNESS AND DEATH.**

- THE GENERATOR PRODUCES DANGEROUS FUMES WHEN IT IS RUNNING. SEVERE PERSONAL INJURY, DEATH, AND EQUIPMENT DAMAGE CAN RESULT FROM OPERATING THE GENERATOR IN A GARAGE, BUILDING, OR A CONFINED SPACE. WHENEVER THE MOTORHOME IS PARKED OR STORED IN A GARAGE OR CONFINED SPACE, DISABLE THE AGS SYSTEM TO PREVENT THE GENERATOR FROM AUTOMATICALLY OPERATING.
- TO AVOID EXHAUST GAS ENTRY INTO THE MOTORHOME, KEEP WINDOWS CLOSED WHEN THE CHASSIS OR GENERATOR ENGINES ARE RUNNING.
- Test the CO/LP detector installed in your motorhome frequently to ensure protection from carbon monoxide and/or LP gas leaks. If an alarm sounds, immediately shut off the generator and all gas and electric appliances and evacuate the motorhome. Turn off the main battery disconnect switch and main gas valve at the LP tank. Seek medical assistance if necessary. Have all necessary repairs to equipment made by a qualified technician before continuing use.
- Disable the AGS system when sleeping in the motorhome. The potential of carbon monoxide poisoning is present when the generator is operating and the CO/LP alarm may not awake you to the hazard.
- When parked, be sure that the generator's exhaust is clear of any obstructions, such as underbrush, rocks, and snow. Follow all generator safety guidelines provided by TMC in your owner's manual and the instruction manual provided by the generator's manufacturer.

### **⚠ CAUTION**

Read and follow all safety, operational, and maintenance instructions printed in the generator manufacturer's user (owner's) manual before using the generator.

Failure to do so could cause severe personal injury or permanently damage the generator.

### **⚠ CAUTION**

Due to the higher cranking amperage requirements to start DIESEL-FUELED generators, it is NOT be advisable to replace lead-acid (AGM or AGS) auxiliary (house) battery(ies) with Lithium-Ion battery(ies). Consult with the generator's manufacturer before changing battery types.

### **NOTICE**

- Your motorhome's generator may be equipped with features that prevent operation if certain maintenance parameters are not met, i.e., low engine oil level, clogged air and fuel filters, etc.
- If your generator fails to start or shuts off unexpectedly, and there is an adequate fuel supply and 12-volts DC present, it may need maintenance attention. Refer to the manufacturer's owner's manual for troubleshooting and maintenance procedures.

### **NOTICE**

#### DUAL-FUEL GENERATORS:

Select TMC motorhomes have dual-fuel generators installed. These generators will operate on either gasoline or propane. A fuel selector mechanism is located on the generator and is accessed by removing a side panel.

Operating and maintenance procedures may differ depending on what type of fuel is used. Please refer to the manufacturer's owner's manual for these and other important safety details.

### **NOTICE**

Beginning in Model Year 2026, the generators installed in Thor Motor Coach motorhomes are compliant to the emissions regulations of the state or province in which the motorhome was originally sold. Refer to the generator manufacturer's website for emissions and other specifications.

The factory-installed generator has an electrical output that is appropriately rated for the electrical demands of the motorhome.

The on-board generator provides 120-volts AC energy when shore power is unavailable. Most generators are designed to operate whether the motorhome is stationary or in-motion, therefore, it is



Typical RV Generators

a convenient source of 120-volts AC power. As when connected to shore power, the generator also works in unison with the converter (See Converter Section) to also supply 12-volts DC to the motorhome, thus conserving auxiliary battery usage.

Always be mindful that exhaust gas produced by the generator contains deadly carbon monoxide gas! **NEVER sleep in the motorhome with the generator running.** Before starting and using the generator, inspect the exhaust system. **DO NOT** use the generator if the exhaust system is damaged, blocked, or restricted. Test the carbon monoxide detector every time the motorhome is in use and become familiar with its alarm sound so that you can quickly react if the alarm is triggered.

## Generator Safety



**IMPORTANT! KNOW THE SYMPTOMS OF CARBON MONOXIDE POISONING. If you or your passengers experience symptoms of carbon monoxide poisoning, seek immediate medical attention:**

- **Dizziness**
- **Vomiting**
- **Nausea**
- **Muscular twitching**
- **Intense headache**
- **Throbbing in the temples**
- **Weakness**
- **Sleepiness**
- **Inability to think coherently**

If you or any of your traveling companions experiences these physical symptoms, move the person to fresh air immediately. If the physical symptoms persist, seek medical attention! Shut the generator down and **DO NOT** operate it until it has been inspected and repaired by a professional technician.



**IMPORTANT! FOLLOW ALL GENERATOR SAFETY GUIDELINES OUTLINED IN THIS AND THE MANUFACTURER'S OWNER'S MANUAL.**

- **NEVER** store anything in the generator compartment. Always keep the compartment clean and dry.
- **DO NOT** operate the generator in an enclosed building or in a partly enclosed area such as a garage.
- **READ** and be familiar with all safety precautions for fuel and exhaust fumes found in the owner's manual.
- **READ** and be familiar with the instructions, cautions and warnings associated with the generator that are provided in the manufacturer's owner's guide.
- **DO NOT** operate the generator when the motorhome is parked in high grass or brush. Heat from the exhaust could cause a fire in dry conditions.

- **DO NOT** operate the generator when parked in close proximity to vegetation, snow, buildings, vehicles, or any other object which could deflect the exhaust under or into the motorhome.
- **NEVER** operate the chassis or generator engine, or the engine of any vehicle, longer than necessary when the vehicle is parked.
- **DO NOT** simultaneously operate generator and a ventilator which could result in the entry of exhaust gas.
- **DO NOT** open nearby windows, ventilators, or doors into the passenger compartment, particularly those which can be 'down wind,' even part of the time. When parked, position the motorhome so that the wind will carry the exhaust away from the motorhome.
- **DO NOT** touch the generator when running, or immediately after shutting OFF. Heat from the generator can cause burns. Allow the generator to cool before attempting maintenance or service.
- **DO NOT** use the generator if the exhaust system is damaged. Before using the generator, inspect the exhaust system. Test the carbon monoxide alarm every time you use the motorhome. If the CO alarm sounds, immediately move everyone to fresh air and ventilate the motorhome. Shut the generator OFF, and **DO NOT** operate it until it has been inspected and repaired by a qualified technician.
- **DISABLE** any automatic generator starting feature or device (AGS), before storing the vehicle or parking it in a garage or other confined space.

## Generator Power Rating

Every generator has a power capacity rating, stated in watts or kilowatts. Most Class C gasoline motorhomes are equipped with generators ranging from 3.2 kW to 4.0 kW. Some Class C diesel models have 6.0 kW generators. Class A motorhomes are supplied with generators ranging from 4.0 kW to 6.0 kW and up to 10.0 kW for the larger diesel models.

Often, this power rating is referred to as the generator's 'size,' which does not refer to the generator's physical dimensions, but its power-generating capacity. The generating capacity of the generator supplied with your motorhome was determined by the supply amperage of the motorhome, 30-amps or 50-amps, and the number of electrical circuits and features of the motorhome. Larger motorhomes typically require more power than smaller models, due to additional electrical features. It is important to know the generating capacity of your motorhome's generator and have a good knowledge of the power demands of the electrical devices installed within the motorhome, both built-in features and the extra electrical devices you bring along with your travels. Typically, devices that use a significant amount of electrical energy are those that contain motors, compressors, and electrical heating elements.

The generator has built-in overload protection, which will turn off electrical power if the demand exceeds what the generator can safely supply. This overload protection device, similar to a circuit breaker, is located on the generator's control panel. Typically, this is not a remotely mounted device. It is important not to exceed the power-generating capacity of the generator by attempting to operate too many appliances at the same time.

## Starting and Stopping Procedures

The generator can be started and stopped from the integral control panel located on the generator, or from an optional remote control panel, or by switches located inside the motorhome. Some AGS systems are equipped with remote generator starting devices, while multiplex systems may offer remote generator control via a smartphone app. Outlined here are the simple steps for starting and stopping the generator:

- Before starting the generator, turn OFF air conditioners and large electrical loads.
- Before starting in cold weather, turn OFF all appliances for best long-term performance.

To start:

1. Ensure the Master Battery Switch is ON.
2. Locate the Generator ON/OFF switch, on the Monitor Panel or integrated into the Multiplex Control Panel.
3. Prime the engine by holding the OFF position of the start/stop switch for a few seconds. The LED on the switch will turn on. Some multiplex systems have a separate PRIME button to press.
 

NOTE: Priming the generator's engine is not necessary or recommended with LP-fueled models. Refer to the manufacturer's operating instructions.
4. After priming, press and hold the ON position until you hear the generator start. The LED will flash during starting, then remain on when the generator is running.
  - a. The engine will turn over and should start within a few seconds.
  - b. If the engine fails to start within a few seconds, DO NOT over-crank.
5. Before turning ON 110-volt AC appliances, allow the generator warm up for a short time. **Generally, a beep from the microwave oven signals that the generator is ready and supplying electricity.**

Under normal operating conditions, you may detect the engine of the generator increase and decrease in RPM (run faster and slower). This is normal, due to changes in electrical power demand.

To stop:

1. Turn off air conditioners and large electrical loads and allow the generator to run for 3-5 minutes before stopping, to allow the generator to cool down.
2. Press and hold the switch in the OFF position until the generator stops. The indicator LED on the switch will turn off.

## Starting with 'Dead' Battery(ies)

If the auxiliary battery(ies) are too depleted, they may not have enough stored energy to start the generator. Of course, in these situations, other 12 volt DC devices will also not be operational.

*There are a couple of things you can do:*

1. If shore power is available, connect to it, allowing the AC-DC converter to charge the auxiliary battery(ies) until there is sufficient stored energy to remotely start the generator. Be sure the Main Battery Switch is ON, so that charging energy can reach the battery(ies).
2. If shore power is not available, start and run the vehicle engine, providing charging energy to the auxiliary battery(ies) from the vehicle's alternator, until there is sufficient stored energy to remotely start the generator. Be sure the Main Battery Switch is ON, so that charging energy can reach the battery(ies).
3. Use the generator's pull-start to start the generator. Most generators are equipped with a pull-start cord, located along the bottom edge of the generator, just below the control panel access cover.
  - a. Remove the Control Panel access cover.
  - b. Press and hold the Start Button.
  - c. Pull the recoil handle (the Prime button may need to be pressed several times).
  - d. When the generator's engine starts, allow it to warm up a minute or so, then ensure the breaker on the control panel is ON, allowing energy from the generator to the motorhome's main circuit panel.

NOTES:

- To prevent generator overload due to initial start-up current demand, turn ON air conditioners and appliances in a sequential order and only after the generator is started and runs for a few minutes.
- If you lose power to the motorhome while operating the generator, check the overload circuit breaker on the generator; it may have tripped due to too much power demand. Turn off some appliances or electrical devices in order to reduce the total power demand.

- Control switches for operating the generator are located on the monitor panel or, if equipped, on the multiplex touchscreen panel.
- The generator will continue to run after a circuit breaker trips. Turn off all appliances before resetting the breaker. If the breaker trips again with all electrical loads off, turn off the generator and contact a qualified technician for repairs.
- If your motorhome is supplied with an AGS system, refer to your motorhome's Owner's Packet for details regarding its features, set-up programming, and operation.
- If your motorhome has a multiplex wiring system, settings for the automatic generator start system are incorporated in the Settings Menu of the multiplex system.
- For complete generator instructions, refer to the manufacturer's guidelines included in your Owner's Packet, or available through your TMC Owners Resource account, or available from the manufacturer's website.
- Propane-fueled generators draw operating fuel from the LP tank. There is no fuel-limiting provision, therefore, monitor LP usage to ensure an adequate supply of LP remains available for other LP appliances (furnace, refrigerator, stove, water heater).
- The generator's manufacturer may recommend special procedures if operating at higher altitudes, unusually hot or cold ambient temperatures or other extreme conditions. Always refer to the operational, safety, and maintenance procedures that are specific to the installed generator in your motorhome, which are outlined in the manufacturer's owner's manual.
- For dual-fuel generators, the fuel selection valve is manually actuated and is located behind the front panel of the generator. Printing on the valve indicates the direction to rotate for gasoline or LP. **Only change the fuel source while the generator is OFF.**

## Fuel and Dual-Fuel Generators

### NOTICE

Depending on the motorhome chassis engine's fuel (diesel or gasoline), your motorhome may be equipped with a diesel, gasoline, or propane (LP) fueled generator.

Some generators are fuel-fuel capable, able to operate on either gasoline or propane. Specifications of your generator should be included in your owner's packet. If you are unsure of the fuel type for the generator installed, contact your dealer or TMC Customer Care.

Depending on the motorhome model, generators may be fueled by either gasoline, diesel, or propane (LP). Some motorhomes are equipped with dual-fuel generators, having the ability to operate on either gasoline or propane. Dual-fuel generators allow for flexibility; gasoline provides a higher BTU rating, and propane generally runs cleaner and quieter. Depending on the fuel type, there are differences in operation and maintenance procedures. Refer to the manufacturer's owner's manual for complete operational, safety, and maintenance procedures.

#### NOTES:

- All generators require 12-volt DC power to start. Operating fuel is drawn from the motorhome's fuel tank (gasoline or diesel). If the fuel level of the motorhome's fuel tank drops to or below  $\frac{1}{4}$  full, the generator will automatically shut OFF and cannot be restarted until the motorhome's fuel tank is filled to above  $\frac{1}{4}$  full.



Fuel selection valve. Rotate for gasoline or propane operating fuel.

## Automatic Generator Start (AGS)

### **⚠ DANGER**

**Disable the AGS system when sleeping in the motorhome or when the motorhome is parked in a garage or confined space. The potential of carbon monoxide poisoning is present when the generator is operating.**

### **⚠ WARNING**

**Fully disable the Automatic Generator Start (AGS) system before performing service and maintenance procedures on the generator.**

**Failure to do so may result in death or severe injury.**

Your motorhome may be equipped with an Automatic Generator Start (AGS) system. The purpose of an AGS system is to automatically start (and run) the generator when certain programmed parameters are encountered. An AGS can be a

stand-alone system, part of the generator's control circuitry, or part of the inverter's control system. AGS operational parameters (settings) are typically entered on the multiplex control system's touchscreen panel (when equipped). Most multiplex-based AGS systems and some stand-alone AGS systems offer remote AGS setting via a Bluetooth-enabled smartphone or tablet app.

Typical AGS programmable parameters are:

- When the auxiliary battery(ies) voltage drops to a predetermined level, the AGS circuitry will sense the low voltage condition and start the generator, which, in turn, supplies charging voltage to the batteries through the inverter or converter-based battery charger. Once the system batteries have regained a sufficient amount of charge, the AGS will automatically turn off the generator.
- When there is a power demand from air conditioners, some models may feature a thermostat interface, where if the temperature of the coach rises to a programmed level, the generator will start, allowing the air conditioner to operate. The AGS will automatically turn off the generator after the air conditioner turns off.

NOTE: This feature is useful when boondocking, or anytime the motorhome's air conditioner(s) are not being powered by a shore power source.

- Some units are time-programmable, enabling the user to determine when the generator will operate. This feature is useful if the campground has restrictions regarding running generators during certain time periods of the day or night.
- Some units may also have 'shore power sense', so that when shore power is connected, the AGS system will place the generator in a stand-by mode, only allowing the generator to operate if electrical demand cannot be fulfilled by shore power alone.

NOTE: This feature typically requires a special transfer switch that will allow the generator's output energy to augment the incoming shore power energy while preventing the generator's electrical energy to back-feed the shore power source.

- When motorhomes are equipped with a 12-volt DC compressor type refrigerator, the AGS will automatically start the generator when the auxiliary battery(ies) drop to a programmed voltage level, therefore, keeping the refrigerator operational. Then, when the auxiliary battery(ies) has reached a state of full-charge, the AGS will automatically turn OFF the generator.
- Some AGS systems allow setting generator total run-time limits. This feature is useful as a reminder to perform routine generator maintenance procedures.

Refer to the manufacturer's instructions for complete AGS operating and safety information. Copies are included in your Owners Packet or on-line through the TMC Owners Resource Information Service.

## AGS10 Automatic Generator Start

TMC Class C Chevy-based motorhomes and Ford-based motorhomes with TMC's ESPEC package may be equipped with an Automatic Generator Start (AGS) known as the Namsung AGS10 system. In addition to the functions listed in the previous section, this AGS system includes:

- AGS ON/OFF switch located just inside the motorhome's entrance door (see illustration below).
- Remote control and AGS settings via a Bluetooth-linked smartphone app (Apple or Android).
- A temperature sensor is also housed within this switch unit that provides a signal to the AGS system to turn on the generator, and thereby the air conditioner, when AGS is used to control motorhome cooling.



AGS10 operating switch. The switch includes an indicator that illuminates when AGS is engaged.

### Key Fob:

**For Class C Motorhomes only**, the AGS10 system may include a Bluetooth-linked Key Fob that allows remote control of **Class C** cab door locks and remote Start/Stop of the motorhome's generator (see notes).

- Remote cab door LOCK/UNLOCK via key fob:
- Remote generator START/STOP via key fob.
  - PRESS 1 to START the generator.
  - PRESS 2 to STOP the generator.



- ← Door Lock
- ← Door Unlock
- ← Generator Start (long press)
- ← Generator Stop (long press)

AGS10 Key Fob Actions.

## Automatic generator control:

- When the measured interior temperature is higher than the set start temperature (when temperature probe is used); making it possible to automate the operation of the rooftop air conditioner.
- The auxiliary battery voltage reaches a preset low voltage; charging the auxiliary battery(ies) via the controller being powered by the generator.
- Not allowing automated generator operation during preselected quiet times.
- Prevents generator operation beyond the programmed maximum run time, allowing for proper generator maintenance and service.

## NOTES:

- AGS10 operating settings can ONLY be made through the Remote Mobile App.
- Connecting the Remote Mobile App to the AGS10 system requires an App Login Passcode. This passcode is printed on a Quick Start Guide, included in your TMC Owner's Packet and a label installed on the inside of the glove box lid. Retain this passcode in a safe and retrievable location.
- Only one Bluetooth device can connect to the AGS10 system at a time. Therefore, if two or more users have the mobile app installed on their smartphone, the initial user must disconnect before the second user can connect to the system.
- Reconnecting to the AGS10 after disconnecting a mobile device may take more time than usual due to the time required for the system to scan for authorized users.
- The AGS10 system is supplied with 1 key fob. Additional key fobs cannot be added to this system. If a replacement key fob is needed, please contact your selling dealer. Key fob Bluetooth pairing is covered in the manufacturer's instructions.
- The Namsung Key Fob with remote door lock/unlock and generator start/stop is not typically available with TMC ESPEC motorhomes. However, early model year ESPEC motorhomes may have been equipped with a Namsung Key Fob.  
  
Typically, Chevy-based Class C motorhomes that are equipped with an AGS10 system are provided with a fully functional Namsung Key Fob.
- Beginning in mid-model year 2025, Ford Class C chassis' may be supplied with a Ford Factory Key Fob that

provides keyless entry to the cab. These motorhomes may not be supplied with an AGS10 Key Fob. However, if a Ford Class C is supplied with both a Ford and AGS10 key fob, the door remote function on the AGS10 key fob is disabled.

- With all AGS10 installations, remote monitoring and generator controls are available through a smartphone app.
- Review the manufacturer's owner's guide for smartphone pairing, operational instructions, and remote operation. This information is available through your on-line TMC Owners Resource account.

## AGS15 Automatic Generator Start

TMC Class C motorhomes built on a Ford E-350/450 chassis are equipped with the Touch N' Go Control, AGS15 automatic generator start (AGS), and systems monitoring via the dash radio. Additional AGS information is available in this manual and through your TMC Owners Resource account.

Information courtesy of Dual Electronics Corporation.

## Automatic Transfer Switch

 **WARNING**

The transfer switch provides protection from reverse polarity and ground faults due to faulty incoming AC power from the shore power source or generator.

**DO NOT DEFEAT THESE PROTECTIVE FEATURES. SEVERE DAMAGE TO THE ELECTRICAL SYSTEM, INCLUDING ELECTRICAL SHOCK COULD OCCUR.**

**NOTICE**

Some automatic transfer switches are designed with a feature called 'Shore Sense.' When equipped, this feature allows for a more intelligent interaction between the AGS system, the on-board generator, and shore power.

When the motorhome is **connected to shore power**, Shore Sense sends a signal to the AGS system controller (or multiplex system controller) detecting the presence of shore power. In turn, the AGS controller prevents the generator from operating when a trigger, such as the air conditioner turning on, or low auxiliary battery voltage is encountered. This ensures that energy to fulfill these electrical demands is first and foremost, provided by shore power, not the generator.

Without Shore Sense, it would be possible for the AGS to trigger the generator to start even when shore power is present. Therefore, Shore Sense helps to eliminate unnecessary generator usage, however, Shore Sense

**still allows the generator to augment shore power whenever the shore power source is inadequate to fulfill the electrical demands of the motorhome.**

The Automatic Transfer Switch is an electronically controlled relay that senses the presence of 120-volts AC incoming power; either from shore power or from the on-board generator. It automatically switches between these two incoming power sources, connecting the active incoming power source to the Power Load Center, thereby powering the motorhome's electrical system.

When 120-volts AC is not present, the Automatic Transfer Switch connects the auxiliary battery to the house 12-volt system. If an inverter is installed, limited 120-volts AC is available for a restricted number of circuits and appliances.

The Automatic Transfer Switch operates under these conditions:

- When shore power is sensed, it connects this external AC power source to the Power Load Center.
- If there is a shore power outage and the generator is started, either manually or by the Automatic Generator Start System, incoming power is switched from the shore power source to the generator after a 20-45 second delay.
- If shore power returns while the generator power is present, the system remains on generated power until the generator is turned off. With the generator off, electrical power for the motorhome is switched to the shore power source.
- The generator overrides shore power.
- If 120-volts AC is not present when the motorhome is either connected to shore power, or the generator is operating, check the circuit breakers at the shore power source and/or the output of the generator.

**Transfer Switch Power Protection:**

TMC motorhomes are equipped with transfer switches that provide reverse polarity and open ground protection. If there is an electrical fault with the shore power source or generator, a fault warning message will be displayed either on the multiplex main panel screen or an indicator on the monitor panel and power will not be passed through the transfer switch to the motorhome.

**If a fault message is displayed:**

1. Contact the park maintenance personnel to check the wiring of the shore power source. **DO NOT ATTEMPT TO REPAIR A FAULTY SHORE POWER SOURCE. LEAVE IT TO A PROFESSIONAL ELECTRICIAN.**
2. If 120-volts AC is NOT present while attempting to supply power with the on-board generator, check the circuit breakers on the generator.
  - a. Turn OFF air conditioner and other electrical appliances.
  - b. Reset circuit breakers if needed.

- c. Re-start the generator and after 30 seconds, turn ON electrical appliances. If power is not restored, have a qualified service technician investigate possible problems with the generator or transfer switch.

*NOTE: The transfer switch supplied with your motorhome is rated for either 30-amp or 50-amp service, depending on the electrical system configuration of your motorhome.*

## Electrical Load Shedding

### **NOTICE**

**During electrical load shedding cycles, certain electrical devices or appliances may not be operational, or temporarily turned off due to preset electrical demand parameters, where some electrical devices will have power preference over other devices.**

**For example, a microwave oven may have power preference over an air conditioner whenever the motorhome's electrical energy is being supplied by a restricted power source.**

**For some TMC brands, the rear air conditioner is turned off by the load shedding function and it may not turn back on automatically. Therefore, it may be necessary to turn off the thermostat, then turn it back on; allowing the air conditioning unit to reset and become operational.**

Your motorhome's electrical system may be equipped with an automatic load shedding circuit, which is designed to prevent circuit-breaker tripping when certain overload conditions exist; usually while operating on generator power. Load shedding parameters can operate quite differently, depending on the particular factory-installed equipment of the motorhome. Following, is a brief description of load shedding operation for certain TMC models:

**Class A Gas motorhomes without multiplex:**

Electrical Load shedding is activated in this condition: when operating on generator power and the roof air conditioner(s) are ON; the rear air conditioner is disabled (load shedded) while the microwave oven is operating. The air conditioner comes back ON after the microwave oven is turned off and after a two-minute period, which allows the air-conditioner to depressurize.

**Class A Gas motorhomes with multiplex:**

If your gas Class A motorhome is equipped with a multiplex system, load shedding is usually controlled by settings programmed into the multiplex system (integrated energy management). The system monitors the current being drawn through the main circuit breakers and sheds loads as needed, usually in a programmed sequential order. With multiplex systems, automatic load shedding can occur on generated power and shore power,

which is very useful at times when a 50-amp electrical system is limited to a 30-amp shore power service. Some integrated energy management systems allow for the selection of 10 or 20 amp service as well; useful for times when plugging into a household circuit to maintain battery charging, or keeping a refrigerator or air conditioner operating during short-term storage.

## DC to AC Inverter

### **⚠ WARNING**

**Review all manufacturer's information and observe all manufacturer's safety warnings and cautions before using the inverter installed in your motorhome.**

**The factory-installed inverter is not intended for use with medical device(s).**

### **⚠ CAUTION**

**Some appliances and equipment may not operate correctly from the modified sine wave of an inverter, and other appliances may actually be damaged if operated on inverted power.**

**Check with the device manufacturer regarding the suitability of use with an inverter.**

Select TMC motorhomes are equipped with an inverter. An inverter takes 12-volts DC power from the auxiliary (house) battery(ies) and transforms it into 120-volts AC power. It is mainly used to power a few select electrical circuits and devices when an external source of 120-volts AC power is not available, or when it is not appropriate to operate the on-board generator. Inverters are also installed in motorhomes that have a household-type refrigerator (compressor, instead of an evaporator type). These appliances usually require 120-volts AC in order to operate, therefore the inverter allows the refrigerator to be used whenever shore power or generator power is not available.



Typical inverter: model, features, and installation location varies, depending on motorhome model and floor plan.

Some inverters include a built-in automatic transfer switch, which will connect the inverter to the electrical system when needed and disconnect when either shore power or generated power is detected. In addition, some inverter models also perform the function of a converter (supplying 12-volt DC power from a 120-volt AC source). Inverter/Converter models are mainly installed on Class A diesel motorhomes. Although wiring varies from model to model, in general terms, the inverted-powered outlets are those that feed power to the main TV, household-type refrigerator (if installed), and a few essential AC power outlets.

All inverters have a wattage rating that will indicate the maximum load (or electrical power) the inverter can supply. For example, an 1,800 watt inverter will be able to provide approximately 15-20 amps of current (amperage). Sometimes, the wattage capacity is stated in kilowatts (kW). For example, 1,800 watts becomes 1.8 kW. Depending on the model and floor plan, TMC typically installs inverters with power ratings of 1,000 watts, 1,800 watts, or 2,000 watts.

Since the inverter is drawing power from the auxiliary battery(ies), the condition and storage capacity of the batteries determines how long the inverter can supply power to the motorhome's 120-volt AC devices. Keep in mind that while traveling, a charging voltage to the batteries from the vehicle's alternator is available, as long as the master battery switch is ON. Maintaining a charging voltage to the auxiliary battery(ies) will prolong the energy available from the battery(ies) to the inverter.

Battery voltage is also important for proper inverter operation. Most inverters have an automatic shut-off feature that turns the inverter off in the event that the incoming voltage of the supply battery(ies) drops out of range; usually below 10 volts DC or above 16 volts DC.

For details regarding the inverter supplied to your motor-home, its features and functions, please refer to the manufacturer's operational guide included with your Thor Motor Coach Owner's Packet, available through the TMC Owners Resource service, or directly from the inverter manufacturer's website.

## Inspection and Maintenance

Most inverter installations include a separate circuit breaker installed in the battery compartment, near the auxiliary battery. This circuit breaker protects the inverter from overloads (attempting to draw more power from the inverter than it is designed to supply). If the inverter is not working, check to determine if this circuit breaker is 'tripped' (device with a blue reset button). If so, re-set it and reduce power consumption through the inverter. Also check the fuse located on the inverter. Inverters are typically installed behind a panel or bed pedestal near the Power Load Center (fuse and circuit breaker panel). There are no consumer serviceable parts inside the inverter case and the manufacturer's warranty will be void if the case has been opened. The inverter's cooling fins and the cooling fan must be kept clear of any obstructions. If you have further concerns, contact your dealer.

Typical Inverter Circuit Breaker located in the battery compartment.



#### NOTES:

- The condition of the auxiliary battery should be monitored when using the inverter. During some load conditions, it is possible to completely deplete the stored energy of the battery(ies).
- Calculating the total power consumption (in watts) is very important for proper inverter use. DO NOT exceed the power output rating of your inverter.
- Inverters will safely operate most AC loads within their power rating. However, some appliances and equipment may not operate correctly with the modified sine wave of inverted power and actually be damaged if operated by an inverter. It is especially important to check all medical devices to determine if they can operate safely with inverted power.
- Except for the TMC Class B motorhome outfitted with the Re(Li)able battery power system, inverters do not power air-conditioning units.
- An extended yellow lever on the inverter's circuit breaker (see photo above) indicates a tripped circuit breaker. Locate and correct the overload, then move the lever back into the housing. The blue button is a circuit breaker test device. Pressing the blue button will disconnect the inverter from the battery(ies).
- Electrical diagrams for your motorhome will indicate inverted circuits and are available through the on-line Owners Resource service.

## Power Load Center, 30-amp, All-in-one

The All-in-One, 30-amp Power Load Center provides electrical control for both 120-volt AC and 12-volt DC circuits. This unit consists of three main components:

- 120-volt AC Circuit Breaker Panel
- 12-volt DC Fuse Panel
- Converter

The Power Load Center is usually located in the rear bed pedestal or a rear closet, but may be located elsewhere within the motorhome. Each circuit of the main power panel is labeled according to the device(s) connected to it.



Typical 30-amp Power Load Center with integrated converter

## 120-volt Circuit Breaker Panel

### **⚠ DANGER**

- **DO NOT force a tripped circuit breaker into resetting. A tripped circuit breaker indicates a problem with the circuit that must be corrected.**
- **DO NOT replace circuit breakers with one of a higher current rating.**
- **DO NOT replace blown fuses with a fuse of a higher current rating.**
- **Circuit damage could result, creating the potential of electrical shock, electrocution, and fire.**

### **⚠ WARNING**

- **A qualified RV electrician should perform any repairs to the electrical system of your motorhome. If misused, electrical energy is dangerous and can cause fires, electrical shock, or electrocution.**
- **Replacement circuit breakers must be of the same voltage, amperage rating, and type. NEVER use a higher rated replacement circuit breaker than what was originally installed with your motorhome. Doing so may cause a fire by overheating the motorhome's wiring.**



Typical 30-amp circuit breaker and fuse panel. Note circuit and device labels.

The 120-volt AC section of the Power Load Center contains toggle-type circuit breakers. Circuit breakers protect the 120-volt wiring and components from circuit overloads and shorted circuits. Should a circuit overload or short circuit occur, the circuit breaker protecting the affected circuit will 'trip,' preventing the flow of electricity through that circuit.

A circuit breaker identification label is permanently attached to the inside surface of the 120-volt AC Load Center. The circuit breakers will not offer complete protection of the motorhome electrical system in the event of a power surge or spike.

If a circuit breaker trips, turn OFF and unplug the electrical appliance(s) or devices on that circuit and allow the circuit breaker to cool down. After the cool down period, reset the circuit breaker by moving the switch to the OFF position and then back to the ON position, then plug-in the electrical devices and try operating them. If the circuit breaker re-trips or frequently trips, unplug the appliances(s) on the circuit and contact your selling dealer's service department to have the electrical problem diagnosed and repaired. It is possible that the appliance is faulty, not the circuit.

If the circuit breaker refuses to re-set, this indicates there is something wrong with that circuit. **DO NOT ATTEMPT TO FORCE IT TO THE ON POSITION:**

- The circuit may be overloaded with too many devices.
- The device may draw more current than what the circuit is designed to supply.
- The device may have developed an internal short circuit.
- The circuit wiring or outlet (receptacle) may be damaged.



**IMPORTANT! DO NOT ATTEMPT TO USE A FAULTY CIRCUIT OR ELECTRICAL DEVICE UNTIL THE PROBLEM IS DIAGNOSED AND REPAIRED BY A QUALIFIED ELECTRICIAN.**

#### NOTES:

- Circuit breakers and fuses are vital in keeping the electrical system of your motorhome in a safe operational condition. NEVER bypass or defeat circuit breakers or circuit fuses.
- Some electrical appliances may have their own circuit breakers. If there is an interruption in electrical service of an appliance, consult the manual for that appliance to determine the recommended action to take.
- For select motorhomes equipped with a multiplex wiring system, the power load center and associated circuit breaker/fuse panels is quite different than the power load center described in this section.
- For information regarding multiplex wiring systems, please contact your selling dealer or a TMC Customer Care representative.

## Maintenance

Before using the motorhome after a long period of storage, inspect the circuit breakers and replace them as needed. Test each circuit breaker by moving the individual switches to the OFF position, and then back to the ON position. Circuit breakers may degrade over time and, as part of proper motorhome maintenance, must be replaced as needed.

## 12-volt Fuse Panel

### WARNING

**Replacement fuses must be of the same voltage, amperage rating, and type. NEVER use a higher rated replacement fuse as it may cause a fire by overheating your motorhome's wiring.**

The circuits that receive power from the 12-volt DC section of the Power Load Center are protected by automotive blade-type (ATC) fuses. The 12-volts DC fuse panel label indicates fuse sizes, positions, and the electrical components powered through the 12-volt circuits. To determine if a fuse has BLOWN (unable to pass electricity), it must be pulled from its socket and visually inspected. A blown fuse will have a distinct, open gap in the wire or conductor between the fuse blades.



ATC Blade-Style Fuse



Automotive-type 12-volt fuses

Only replace blown fuses with fuses of the same size and current rating of the fuse that was originally supplied in the fuse socket. Each socket is labeled with the correct current rating. Replacing any fuse with a higher current rated fuse will create an unsafe condition, possibly causing circuit damage and a fire.

A blown fuse indicates a problem with the circuit that is associated with the fuse. Immediately determine the cause and take corrective actions whenever a fuse is blown. Possible causes of blown fuses are:

- Too many devices attached to the circuit, causing circuit overload;
- The circuit may be overloaded by a device that demands more energy than what the circuit is designed to deliver;
- A short-circuited or defective device attached to the circuit;
- A short-circuited wire or outlet associated with the circuit.

Before replacing a fuse always shut OFF the engine, generator, and all motorhome electrical systems completely. Make sure the electrical components listed on the fuse label are in the OFF position:

1. Shut OFF the chassis engine.
2. Disconnect the shoreline power cord.
3. Shut the generator OFF (if equipped).
4. Turn the inverter OFF (if equipped).
5. Turn OFF the master battery switch.
6. Remove the fuse panel cover.
7. Turn OFF the electrical device identified on the fuse label.
8. Pull the fuse straight out of the fuse block. If inspection of the fuse confirms that it is not blown, some other electrical problem may exist.

9. Insert a new fuse of the same specified voltage, amperage rating, and type in the original location. **NEVER** use a higher rated replacement fuse. Additionally, lower-rated fuses will likely blow, for they will not allow adequate current for the device(s) on that circuit.

The fuse panel label should be kept permanently affixed to the motorhome. The fuses will not offer complete protection of the motorhome electrical system in the event of a power surge or spike. Fuses are maintenance components and must be replaced as needed. Please contact your selling dealer's service department for further repair assistance.

Take corrective action to repair any defective electrical circuit or device. If help is needed, seek assistance or repairs from a qualified RV electrician or technician.

*NOTE: Blade-type fuses come in several sizes; mini, standard and large. The fuse sockets of the Power Load Center only accept standard ATC-size blade type fuses.*

*Keep a supply of properly rated blade-type fuses on hand in case a fuse needs to be replaced. Replacement fuses can be obtained at auto parts stores or auto repair facilities.*

## AC to DC Converter

### **NOTICE**

**If the converter is not operating correctly, the reverse polarity protection fuse may be blown (located on the converter front panel). Check the connections on the auxiliary battery(ies) for proper polarity and correct if necessary. If a fuse requires replacement, only replace with one of the same type and rating.**



Typical AC to DC converter: model, features, and installation location varies, depending on motorhome model and floor plan.

When 120-volts AC is present, either by an external power source (shore power) or the generator, 12-volts DC power requirements for the motorhome are provided by the converter. The converter is a switching power supply, effectively transforming 120-volts AC to 12-volts DC; providing power for lights, slideouts, awnings, battery charging, and other 12-volt DC-powered items. The output of the converter is connected to the 12-volt fuse panel, which in turn, provides electrical power to each 12-volt circuit. Whether your motorhome has a 30-amp or 50-amp electrical service, and if the converter is part of the Power Load center or a stand-alone unit, the converter is designed to integrate with the Power Load Center, becoming an integral part of the power distribution system of the motorhome.

#### Converter operation modes:

Most converters are automatic three-stage switching power supplies. The converter senses which mode it needs to be in by sensing the demands of the motorhome's power distribution system.

*The three modes/stages of operation include:*

- **Absorption mode/Normal operation:** The converter normally provides a constant target output voltage of 13.6 volts (nominal) to power all the branch circuits. However, it is current limited, and if the output (load) current reaches its maximum, the output voltage will drop as necessary to hold the converter's maximum output current level (the amperage rating) without exceeding it.
- **Bulk mode/Charge mode:** If the output current reaches its maximum (normally caused by a discharged battery), this will cause the converter to go into Bulk Mode, which means the target output voltage will change to 14.4 volts and a timer will start. Although the converter is outputting 14.4 volts, the voltage increase will not be detectable on a voltmeter due to the voltage-current relationship. The actual output voltage will not rise until the load is reduced, which happens naturally as the battery charges or if 12-volt appliances are turned off.
 

Bulk Mode will be maintained until the current draw drops to approximately 5 amps, or until the timer reaches four hours (whichever happens first). Then the target output voltage is changed back to 13.6 volts for Absorption Mode. Lights that are powered from the output may change brightness slightly at that time.
- **Float mode/Trickle charge:** After the output has been maintained at 13.6 volts (Absorption Mode) for 44 hours, the converter will change to Float Mode with an output of 13.2 volts. This output may then reset to Absorption Mode (13.6 volts) if power is interrupted, or to Bulk Mode (14.4 volts) if the output current limit is reached.

#### NOTES:

- *While in Float Mode, the converter will supply a trickle charge to the battery. If the motorhome is in storage for any length of time, check the battery(ies) and battery fluid levels every 3 weeks.*
- *In order for electrical charging energy from the converter to connect to the auxiliary battery(ies), the master battery switch must be ON.*

If the transfer switch does not sense 120-volts AC at its input, it automatically switches the auxiliary (house) batteries to the 12-volt DC electrical system and the auxiliary batteries become the source of 12-volt power. When connected to a 120-volt AC power source, the transfer switch automatically disconnects the auxiliary batteries from the 12-volt electrical system and again, the converter becomes the source of 12-volts DC power.

### Using the Converter

Under normal operating conditions, the converter requires no user attention or maintenance. However, if the auxiliary batteries happen to become reverse connected, fuses that protect the converter from cross-polarization may blow. If the converter is not operating, check the polarity of the auxiliary battery connections and correct if necessary. If the fuses on the front panel of the converter have blown, replace with the same type and amperage rating. If the incoming AC voltages are normal, but the converter output is still **NOT** delivering 12-volts DC, the converter requires repair. Contact the manufacturer for service details.

*The converter has several design features that protect it and the 12-volt electrical system of the motorhome.*

- **Over-Temperature Protection:** If the internal temperature of the converter exceeds a critical point, it will shut down. This protects the unit from excessive heat that may damage sensitive components. The unit will restart once the internal temperature of the converter has dropped to a safe level.
- **Electronic Current Limiting:** In the event that the output current exceeds the maximum rating for the WF-9800 Series Converter/Charger, the output current will remain constant, but the output voltage will begin to drop. If this occurs, the unit will recover once loads are reduced.
- **Short-Circuit Protection:** Should a short circuit occur in the motorhome's 12-volt system, the WF-9800 Series Converter/Charger will drop the voltage output to zero volts. If the short-circuit condition is removed and no other fault conditions are detected, the converter will resume normal operation. However, short-circuit conditions are dangerous, and the electrical system will require inspection by a qualified service technician.

Due to the high level of electrical energy it supplies, the converter may be warm to the touch when operational, and this is normal. It does, however, have built-in thermal protection; if it gets too hot, it will turn itself off. After it cools down, the converter will return to normal operation. In most cases, this thermal cycling is caused by some object being placed in too close of proximity to the converter, preventing it from receiving adequate ventilation.



**IMPORTANT! DO NOT OBSTRUCT VENTILATION OPENINGS. Make sure not to place anything near the converter that could obstruct ventilation.**

Inspection and maintenance:

If the power converter is not working, check the fuse(s) located on the outer case. There are no consumer serviceable parts inside the converter case and the manufacturer's warranty will be voided if the case has been opened. If you have further concerns, please contact your selling dealer.

## Power Load Center, 50-amp

### DANGER

- **DO NOT force a tripped circuit breaker into resetting. A tripped circuit breaker indicates a problem with the circuit that must be corrected.**
- **DO NOT replace circuit breakers with one of a higher current rating.**
- **DO NOT replace blown fuses with a fuse of a higher current rating.**

**Circuit damage could result, creating the potential of electrical shock, electrocution, and fire.**

### WARNING

- **A qualified RV electrician should perform any repairs to the electrical system of your motorhome. If misused, electrical energy is dangerous and can cause fires, electrical shock, or electrocution.**
- **Replacement circuit breakers must be of the same voltage, amperage rating, and type. NEVER use a higher rated replacement circuit breaker than what was originally installed with your motorhome. Doing so may cause a fire by overheating the motorhome's wiring.**
- **Replacement circuit breakers must be of the same voltage, amperage rating, and type. NEVER use a higher rated replacement circuit breaker than what was originally installed with your motorhome. Doing so may cause a fire by overheating the motorhome's wiring.**

Except for a few smaller models, almost all TMC Class A motorhomes are equipped with a 50-amp power service, which includes the following:

- Power Load Center, including 120-volt AC circuit breaker panel and 12-volt DC fuse panel or 12-volt DC breaker panel;
- Stand-alone Converter.

The Power Load Center is usually located in the rear of the motorhome; in a bed pedestal, closet, or wall panel. Although the location differs, all power load panels are readily accessible, regardless of slideout positions.

Each circuit of the power load center is labeled according to the device(s) connected to it.

## 120-volt Circuit Breaker Panel

The Power Load Center contains toggle-type circuit breakers. Circuit breakers protect the 120-volt wiring and components from circuit overloads and shorted circuits. Should a circuit overload or short circuit occur, the circuit breaker protecting the affected circuit will 'trip,' preventing the flow of electricity to that circuit.

A circuit breaker identification label is permanently attached to the inside surface of the 120-volt circuit breaker panel. The circuit breakers will not offer complete protection of the motorhome's electrical system in the event of a power surge or power spike. Delicate electronic devices should be protected by separate surge protectors (customer supplied).

If a circuit breaker trips, turn OFF and unplug the electrical appliance(s) or devices on that circuit and allow the circuit breaker to cool down. After the cool down period, reset the circuit breaker by moving the lever to the OFF position and then back to the ON position, then plug-in the electrical devices and try operating them. If the circuit breaker re-trips or frequently trips, unplug the appliances(s) on the circuit and contact your selling dealer's



Typical 50-amp Power Load Center

service department to have the electrical problem diagnosed and repaired. It is possible that the appliance is faulty, not the circuit.

If the circuit breaker refuses to re-set, this indicates there is something wrong with that circuit. **DO NOT ATTEMPT TO FORCE IT TO THE ON POSITION:**



**IMPORTANT! DO NOT attempt to use that circuit or device until the problem is diagnosed and repaired by a qualified electrician.**

- The circuit may be overloaded with too many devices;
- The device may draw more current than what the circuit is designed to supply;
- The device may have developed an internal short circuit;
- The circuit wiring or outlet (receptacle) may be damaged;
- The circuit breaker may be faulty and requires replacement.

#### NOTES:

- *Circuit breakers and fuses are vital in keeping the electrical system of your motorhome in a safe operational condition. NEVER bypass or defeat circuit breakers or circuit fuses.*
- *Some electrical appliances may have their own circuit breakers. If there is an interruption in electrical service of an appliance, consult the manual for that appliance to determine the recommended action to take.*
- *For information regarding multiplex wiring systems and circuit control devices, please contact your selling dealer or a TMC Customer Care representative.*

## Maintenance

Before using the motorhome after a long storage period, inspect and test each circuit breaker by moving the individual switches to the OFF position, and then back to the ON position. Circuit breakers may degrade over time and as part of proper motorhome maintenance, must be replaced as needed.

## 12-volt Fuse Panel

Except for select diesel pusher motorhomes, the 12-volt fuse panel section of the 50-amp Power Load Center is similar in operation to the 30-amp panel described earlier in this section.

## Converter

See previous converter section.

## Multiplex System 12-volt Circuit Breaker Panel

Instead of a fuse panel, select diesel pusher motorhomes with 50-amp electrical service and using a Firefly multiplex system, may have a 12-volt circuit breaker panel. Panels like this are typically located in a rearward closet or service bay.

These panels will contain a list of 12-volt circuits and devices printed on the face and include a corresponding row of LEDs that indicate whether or not the circuit or device is in-service. Along the bottom or side-edge of the panel will be a row of push-button circuit breakers with the prefix label of 'B'. The face label indicates the circuit that is controlled by each corresponding circuit breaker.

If a device LED is not illuminated, press the corresponding circuit breaker button to reset. If resetting the circuit breaker does not restore power to the device, there is either a problem with the device or circuit. If the circuit breaker refuses to re-set, this indicates there is something wrong with that circuit. **DO NOT ATTEMPT TO FORCE IT TO THE ON POSITION:**

- The circuit may be overloaded with too many devices;
- The device may draw more current than what the circuit is designed to supply;
- The device may have developed an internal short circuit;
- The circuit wiring or outlet (receptacle) may be damaged;
- The circuit breaker may be faulty and requires replacement.



**IMPORTANT! DO NOT attempt to use that circuit or device until the problem is diagnosed and repaired by a qualified electrician.**

#### NOTES:

- *On select diesel motorhomes, the master battery switch, along with 12-volt circuit breakers, is located on a panel installed in a service bay of the motorhome.*
- *Contact your dealer or TMC Customer Care if you have questions or concerns about the electrical system installed in your motorhome.*

## GFCI Electrical Outlet

### WARNING

If the GFCI electrical outlet fails **EITHER** the self-test or manual test, turn **OFF** power to the failed circuit at the **Power Load Center**. **DO NOT** restore power to the faulty circuit until proper repairs have been made.

TMC motorhomes are furnished with ground fault circuit interruption (GFCI) protection on specific 120-volt AC electrical outlets. GFCI outlets are found in the bath, while receptacles in the kitchen area and exterior may be electrically connected to this circuit; therefore, also GFCI protected.

The GFCI does not protect against short circuits or electrical overloads. Circuit breakers in the Power Load Center, which supply power to the circuit, will trip if these conditions exist.



Typical GFCI electrical outlet.

GFCI outlets are compliant to the self-test industry standards implemented in 2015. These new GFCI's automatically monitor the presence of ground, and if a ground fault is present, whether a load is plugged in or not, the GFCI shuts off power to the outlet. Although the self-testing feature increases the safety of the outlet, it does not eliminate the need for occasional manual testing of the GFCI circuit breaker to ensure it is working properly. Manually test GFCIs at the beginning of the travel season and monthly thereafter.

To test the GFCI circuit breaker:

1. Make sure power is switched ON to the circuit. Use a test meter, test probe or a low-wattage electrical device.
2. PUSH the test button. The RESET button should pop out.
3. With the RESET button out, all power should be interrupted (OFF) to the receptacle being tested.
4. Verify there is no voltage to the receptacle by using the test probe or low-wattage electrical device.
5. Push the RESET button IN to restore power to the GFCI.
6. Verify that voltage has been restored to the GFCI receptacle.

If the reset button does not pop out after pushing the test button, or GFCI circuit breaker continues to trip, or if the power is not interrupted to the test light, immediately turn OFF power at the main circuit breaker panel and have a qualified electrician repair the circuit or replace the GFCI. **DO NOT** use that circuit until repairs are made.

*NOTE: It is normal RV wiring practice to wire one or more electrical receptacles to the GFCI circuit. If another outlet in the motorhome is 'dead' check the GFCI in the bathroom; it may be tripped.*

If a non-GFCI receptacle is 'dead', check the near-by GFCI circuit breaker; it may need to be reset. If so, unplug all electrical devices from the GFCI receptacle and all receptacles wired to this circuit, and reset it. Then, monitor it for proper circuit functionality.

If resetting the GFCI does not restore power to the non-GFCI receptacle **and** the corresponding circuit breaker in the Power Load Center is **not** tripped, then there is a problem with the electrical circuit or GFCI receptacle. Enlist the service of a qualified electrical technician for repairs. **DO NOT** use that circuit until repairs are made.

## Exterior 120-volt AC Outlet

### WARNING

**NEVER USE AN APPLIANCE OR ELECTRICAL DEVICE THAT IS NOT PROPERLY GROUNDED OR HAS A MISSING OR DEFEATED GROUND PIN. DEATH OR SEVERE INJURY DUE TO ELECTROCUTION IS POSSIBLE.**

Your motorhome may be equipped with a convenient outside 120-volt AC power receptacle that is useful for operating appliances and entertainment devices. For your safety, the outside receptacle is electrically grounded and ground-fault protected (Ground Fault Circuit Interruption, or GFCI).

Powering the exterior outlet

The exterior 120-volt AC power outlet is energized whenever the motorhome is connected to shore power or the on-board generator is running. In typical RV wiring fashion, this receptacle is wired to a circuit that is ground-fault protected and likely includes other receptacles; usually located in the bathroom and kitchen; areas where the likely-hood of water is present. Refer to your motorhome's 120-volt wiring diagram to locate other receptacles on the GFCI circuit.



Typical exterior GFCI-protected 120 volt AC outlet.

*This page is intentionally blank*

## Propane Gas Safety

### **DANGER**

#### IF YOU SMELL PROPANE GAS

1. Extinguish any open flames and all smoking materials.
2. Shut off the propane supply at the container valve(s) or propane supply connection.
3. **DO NOT** touch electrical switches.
4. Open doors and other ventilating openings.
5. Leave the area until the odor clears.
6. Have the propane system checked and leakage source corrected before using again.

IGNITION OF FLAMMABLE VAPORS COULD LEAD TO A FIRE OR EXPLOSION AND RESULT IN DEATH OR SEVERE INJURY.

### **DANGER**

All pilot lights, appliances, and their igniters (see operating instructions) shall be turned off before refueling of motor fuel tanks and/or propane containers.

CAN CAUSE IGNITION OF FLAMMABLE VAPORS, WHICH CAN LEAD TO A FIRE OR EXPLOSION AND RESULT IN DEATH OR SEVERE INJURY.

### **DANGER**

NEVER TRAVEL WITH, AND/OR STORE PROPANE (LP) CONTAINERS OR CYLINDERS INSIDE YOUR MOTORHOME.

Propane cylinders are designed to vent whenever internal pressures reach a certain threshold. Therefore, the potential of a venting propane cylinder presents a gas leak hazard.

CAN CAUSE EXPLOSION, FIRE, AND SERIOUS BODILY INJURY OR DEATH.

### **DANGER**

DO NOT USE GAS COOKING APPLIANCES FOR HEATING, AS THIS CAN LEAD TO CARBON MONOXIDE POISONING, WHICH CAN CAUSE DEATH OR SERIOUS INJURY.

### **WARNING**

THE PROPANE PIPING SYSTEM IS DESIGNED FOR USE WITH PROPANE ONLY.

- **DO NOT** connect natural gas to this system.
- Securely cap inlet when not connected for use.
- After turning on propane, except after normal cylinder replacement, test propane piping and connections to appliances for leakage with soapy water or bubble solution.
- **DO NOT** use products that contain ammonia or chlorine to test for leaks. These substances may weaken piping components and cause gas leaks, leading to fire or explosion, which could result in death or severe injury.

### **WARNING**

TRAVEL-INDUCED ROAD VIBRATION CAN LOOSEN PROPANE FITTINGS. It is important to check the Propane System for leaks at least every 5,000 miles, and whenever the tank is filled. It is also recommended to have the entire Propane System checked annually by a qualified propane service technician.

### **WARNING**

Test the combination carbon monoxide/propane alarm after the motorhome has been in storage, before each trip, and at least once per week during motorhome use.

FAILURE TO DO SO CAN RESULT IN AN UNDETECTED FAULTY CO/LP ALARM, OR AN UNDETECTED GAS LEAK, WHICH COULD LEAD TO EXPLOSION, FIRE, DEATH OR SEVERE INJURY.

### **CAUTION**

Several propane system components are installed underneath the vehicle. Due to their location, these components may be subjected to damage caused by road hazards or other travel-related circumstances.

Regularly inspect the propane system for possible damage and **DO NOT** use the propane system until all damage is properly repaired.

### **NOTICE**

Class A Motorhomes powered by a diesel engine and equipped with a hydronic heating system may not include a propane (LP) system. The furnace and water heater use diesel fuel to generate heat, while the kitchen is equipped with an induction cooktop. Other appliances are powered by electricity; either 12-volts DC or 120-volts AC.

## Introduction

Propane or liquefied petroleum (LP) gas is a clean and efficient source of energy that provides fuel for cooking, heating, hot water, and generating electricity (by a propane-fueled generator, if equipped). Propane is also used as an energy source for refrigeration (evaporative-type RV refrigerators).

Propane is a colorless and odorless gas that, when under pressure, is in a liquefied state. Always be mindful that propane gas can be hazardous if used improperly. Propane is heavier than air, and if leaking, the gas tends to flow and accumulate in low areas, such as the floor. If the smell of propane gas is detected within or around your motorhome or the propane alarm has triggered (CO/LP alarm), quickly and carefully perform the procedures listed on the safety alerts at the beginning of this section and listed in Section 3, Vehicle Safety. There are propane-related safety labels affixed to your motorhome that pertain to propane safety. These, and other safety notices, are placed to remind you to always observe and follow proper handling and safety precautions when using propane gas and propane appliances.

The propane system installed in the motorhome is comprised of numerous components, such as the propane tank, main gas valve, gas hoses, propane gas regulator, gas piping, gas appliances, and copper (or steel) tubing lines and valves within each gas appliance. The information in this section will help you understand, safely use, and maintain the propane system of your motorhome.



**IMPORTANT! STRICTLY OBSERVE ALL PROPANE GAS SAFETY INSTRUCTIONS AND PROCEDURES WHENEVER USING THE PROPANE GAS SYSTEM OR ITS COMPONENTS.**

- **Strictly adhere to all propane warnings printed on propane appliances and devices.**
- **Propane is a colorless and odorless gas that, when under pressure, is in a liquefied state. An odorant (usually a sulfur compound) is added as a warning agent.**
- **Propane is heavier than air; the gas tends to flow to lower areas and will sometimes accumulate in these low areas, such as the floor.**
- **If the smell of propane gas is detected within or around your motorhome, quickly and carefully perform the procedure listed on the safety labels at the beginning of this section and affixed to your motorhome.**
- **Hand tighten the main propane gas system valves; DO NOT use a wrench or pliers as over tightening may damage the valve seals and cause them to leak.**
- **Ensure the combination CO/LP detector is operational and properly maintained (see Section 3 for CO/LP detector details).**
- **As part of your normal maintenance routine (at least once a year), have a qualified propane service technician perform an inspection of your entire propane system, including a system pressure test (appliances, tank, regulator, piping, and fittings).**

## Traveling With Propane

### DANGER

**TURN OFF ALL PILOT LIGHTS, APPLIANCES, AND THEIR IGNITERS (SEE OPERATING INSTRUCTIONS) WHILE THE MOTORHOME IS TRAVELING OR IN MOTION, AND BEFORE REFUELING THE MOTORHOME'S FUEL TANKS AND/OR PROPANE CONTAINERS.**

**CAN CAUSE IGNITION OF FLAMMABLE VAPORS, WHICH CAN LEAD TO A FIRE OR EXPLOSION AND RESULT IN DEATH OR SEVERE INJURY.**

As with all on-board fuel (diesel, gasoline, or other), traveling with propane does present a level of risk, yet risks can be minimized by following a few basic travel precautions.

- Operating a gas appliance(s) while traveling presents the risk of fire and/or explosion if the vehicle encounters some type of road hazard or vehicle damage. To reduce risk, always travel with gas appliances **OFF** and the propane system's main valve **OFF**.
- Some states prohibit propane appliances to be operated during travel, especially in underground tunnels, across bridges, or on a ferry. While traveling, you may also encounter local restrictions against transporting flammable materials (other than the fuel for the motorhome's engine). Make sure you are familiar with the transportation laws for the areas where you will be traveling, by checking beforehand with the state's or province's Department of Transportation (DOT) or similar regulatory office.
- **NEVER** travel or stow auxiliary propane gas cylinders inside the motorhome or inside a non-vented storage compartment. All ASME (American Society of Mechanical Engineers) certified propane gas tanks and cylinders have a safety pressure relief system that is designed to vent propane gas to the atmosphere if a certain internal pressure threshold is reached. A hazardous condition exists if gas venting is contained within the motorhome or an enclosed storage compartment.
- Over time, road vibrations can cause gas fittings and connections to loosen. Make it part of your routine motorhome inspection to check all gas fittings, valves, and connections, for looseness and possible gas leaks.
- Keep the CO/LP detector in good working order and test it at the beginning of your travel season and least once a week while traveling.
- Be sure your traveling companions know what to do if propane gas is detected, either by smell or by the sounding of the CO/LP alarm. **TAKE IMMEDIATE SAFETY ACTIONS WHENEVER GAS IS DETECTED.** Review and practice evacuation procedures.

## Propane Tank

### **⚠ DANGER**

- **ALWAYS SHUT OFF THE ENGINE WHILE REFUELING PROPANE TANK. DO NOT SMOKE. TURN OFF ALL APPLIANCES WITH AUTOMATIC IGNITERS AND DO NOT OPERATE OTHER IGNITION SOURCES WHILE REFUELING.**
- **DO NOT OVERFILL A PROPANE TANK.** Over-filling the propane gas tank can result in uncontrolled gas flow, which can cause fire or explosion. A properly filled tank will contain approximately 80% of its volume as liquid propane.
- **An 80% automatic shut-off valve is installed on the propane gas tank, which will automatically prevent further filling when the gas volume has reached 80% of tank capacity.**
- **If you suspect your propane container has been overfilled, contact your selling dealer or a qualified propane technician for assistance immediately. DO NOT attempt to service or correct a propane container overfill yourself.**

### **⚠ WARNING**

**ALL PROPANE GAS IS CONTAINED UNDER PRESSURE. DUE TO THE DANGEROUS POTENTIAL OF ANY COMPRESSED GAS, IT IS MANDATORY THAT THE FOLLOWING REQUIREMENTS FOR THE USE OF THIS TANK BE FOLLOWED:**

- Tanks are to be installed, fueled, and maintained in accordance with the state and local codes, rules, regulations, or laws and in accordance with the NFPA Pamphlet 58, division IV.
- **NEVER** use another LP tank other than the one furnished with the motorhome. If the LP tank must be replaced, check with your dealer for correct LP tank specifications and replacement procedures.

### **NOTICE**

- **New propane containers are filled with an inert gas, which must be carefully purged before filling with propane. The propane tank must NEVER BE OVERFILLED with propane (more than 80% by volume).**
- **Hand tighten propane gas system valves; DO NOT use a wrench or pliers as over tightening may damage the valve seals and cause them to leak.**

A permanently mounted ASME approved propane container (tank) is located under the floor of your motorhome. Propane expands 1½ percent for every ten degrees Fahrenheit (5.50 C) of increase in temperature. It is imperative to leave sufficient

space inside the container to allow for natural expansion of gas during warmer weather.

#### Monitoring propane levels:

The amount of propane remaining in the propane tank can be monitored by pressing the appropriate monitor buttons on the motorhome's monitor panel or main multiplex system panel (if installed).

#### Filling and servicing:

Given that the propane tank is not removable, the motor-home will need to be driven to a qualified propane facility for filling and servicing. Only an authorized propane service technician(s) should be near the motorhome while the propane tank is being filled. Drivers and passengers should wait at a safe distance away from the motorhome until LP filling and servicing is complete.



**IMPORTANT! NEW PROPANE CONTAINERS ARE FILLED WITH AN INERT GAS, WHICH MUST BE CAREFULLY PURGED BEFORE FILLING WITH PROPANE. THE PROPANE TANK MUST NEVER BE OVERFILLED WITH PROPANE.**

**NEVER** allow the propane tank to be filled above the maximum safe level as indicated by the fixed liquid level gauge. Overfilling the propane container above the liquid capacity indicated on the gauge could allow liquid propane to enter the system that is designed for vapor only, creating a hazardous condition.

#### NOTES:

- The capacity or size of a propane tank is expressed in pounds (lbs.) and correlates to the weight of the propane it is capable of containing when filled to 80% capacity, not the total volume capacity of the tank.
- For example: If your motorhome has a 40 pound capacity LP Tank, filling it to 80% = 32 pounds of LP. LP weighs 4.2 lbs./gallon, so the 80% capacity of a 40 pound LP tank is 7.6 gallons (32÷4.2).



Typical permanently-installed RV propane tank with regulator

## The Propane Gas Regulator

### WARNING

**NEVER ALTER THE POSITIONING OF THE REGULATOR. PROPANE GAS REGULATORS MUST ALWAYS BE INSTALLED WITH THE DIAPHRAGM VENT FACING DOWNWARD. ALSO MAKE SURE TO KEEP THE REGULATOR COVER IN PLACE TO MINIMIZE VENT BLOCKAGE, WHICH COULD RESULT IN EXCESSIVE GAS PRESSURE, CAUSING FIRE OR EXPLOSION.**

For the propane gas to be safely used by the motorhome's appliances, the high fuel pressures within the tank must be reduced. Propane gas pressure reduction is a two step process and is accomplished by the propane regulator; virtually two regulators in one unitized body. The propane regulator assures consistent and proper operating gas pressure, regardless of outside weather conditions or altitude (atmospheric pressure).

The propane regulator is located next to the main LP gas valve (on the tank), inside a cover and in-line with the propane gas supply line. It seldom requires service, however, it should always remained covered and protected from the elements.

The high pressure first stage of the regulator is used to reduce the LP gas pressure to approximately 10 to 13 pounds per square inch (PSI) before encountering the low pressure second stage. This second stage regulator reduces the gas pressure further to 11 inches water column, or about 0.5 PSI. The result is an efficient, low pressure gas supply that helps to eliminate problems such as gas line freeze ups and pilot light outages.

The regulator has been preset by the manufacturer and adjustments should not be necessary. However, if adjustments should be required, DO NOT attempt to adjust the regulator yourself. Adjustments must be made with special equipment and by a qualified propane service technician. Have the regulator pressure checked as part of your routine propane system maintenance schedule, or whenever you suspect that incorrect gas pressures could be causing appliance malfunctions.

Atmospheric air is required for proper operation of the regulator, therefore, it is very important that the regulator vent is kept clean and free of dirt and debris. It is very important to keep the vent facing downward and the regulator covered, protecting it from contamination. A toothbrush can be used to clean the vent if it becomes clogged by foreign matter.

If you believe the propane gas regulator has been damaged or otherwise is not functioning properly, have it serviced or replaced by a qualified propane service technician.

## Preventing Propane Regulator Freeze-up

### **NOTICE**

**When filling the tank for cold weather use, ask the propane supplier to add hydrous methanol to the fuel mixture.**

During cold weather, it is important to keep ice from forming within the regulator, which if happens, will shut off the flow of propane gas to the appliances.

Regulator freeze-ups can occur in any weather if there is moisture in the tank or if the tank has been over-filled. Always use moisture-free propane fuel and make sure the tank is not filled beyond 80% of capacity. If moisture has entered the tank, have the tank purged, or have hydrous methanol added by an authorized propane gas supplier.

The term regulator freeze-up can be misleading. Regulators and propane gas do not freeze, however, water particles that may be present in the fuel will freeze as the expanding propane gas creates a cooling effect as it passes through the regulator. Freezing moisture can build up and partially or totally block the passage of the gas through the regulator. Regulator restrictions can also occur when outside temperatures are low enough to cause frost to form on or near the regulator.

The source of moisture within the propane fuel is varied. It can occur at the refinery or gas bulk plant, in the rail cars used to transport the fuel, or even within the propane tank itself. Moisture intrusion into the propane tank can occur when a tank service valve is left open while the tank is empty, allowing moist air to enter and become trapped.

Take these steps to inhibit or prevent PROPANE regulator freeze-ups:

1. Make sure that the propane tank is free of moisture before refilling. Ask the filling/service technician if tank purging is recommended.
2. If freezing has occurred, have the propane gas dealer purge the propane gas tank before refilling.
3. DO NOT overfill the propane gas tank.
4. Make sure to keep the main service valve on an empty tank closed.
5. Add hydrous methanol or other approved propane gas antifreeze or de-icing agent to the propane fuel during tank filling.
6. Keep the propane gas regulator covered at all times.

### NOTES:

- IF FREEZE-UP DOES OCCUR – Shut off the propane gas at the tank. A frozen regulator may permit propane gas to flow at high pressure, resulting in leaks at appliances or in the lines.
- If a freeze-up does occur, NEVER attempt to thaw with an open flame. Once thawed, be sure to take the proper steps to prevent a re-occurrence. If regulator freeze-up persists, have the system checked by your propane gas supplier.
- As outside temperatures drop, the BTU value of the propane gas is lessened, since the colder liquid propane in the tanks requires the heat from the surrounding air to vaporize. This lowering of BTU value can significantly affect the performance of the propane system.
- In cold weather, you can help ensure proper propane system performance by keeping the propane gas tank as full as possible and reviewing the BTU/hr information posted on propane gas appliances.

## Monitoring Propane Fuel Level

Typically, the propane fuel level is monitored by a display located inside the motorhome, either as part of the Monitor Panel or included on the multiplex system's touchscreen. Propane systems that feature remote monitoring will have a propane level sensor installed within the propane tank.

### Monitor Panel Propane Fuel Level Indicator

For TMC motorhomes without multiplex electrical systems, the LP tank level, along with the freshwater and wastewater holding tank levels, are monitored by an array of four LEDs located on the Monitor Panel.

To operate:

1. Press and hold the LPG switch.
2. One of the 4 LEDs in the array will illuminate, indicating the fuel level of the propane tank; from empty-to-full in 1/3 increments.
3. Read the LP fuel level and release the switch.

Similarly, press and hold the corresponding holding tank switches to monitor holding tank levels (if equipped).

### Multiplex Propane Fuel Level Indicator

Motorhomes equipped with a multiplex control system will have a propane tank level monitor, along with holding tank monitoring, as part of the user/interface touchscreen panel. Propane monitoring is usually located on the Home Menu screen, but it could be placed on other menu screens. As with the Monitor panel, the multiplex system also indicates tank levels, from empty-to-full, in 1/3 increments. The fuel level is monitored in real-time; so as long as the multiplex system's touchscreen is ON (main battery switch must also be ON), there is no need to press an additional button to read the level condition of the propane or other holding tanks.

NOTE: Monitor displays installed in your motorhome may vary from these illustrations due to installed features and available equipment.

LED Condition Indicators

Press the LPG switch. A LED will illuminate indicating the fuel level of the LP Tank.



Monitor panel LED tank level display.

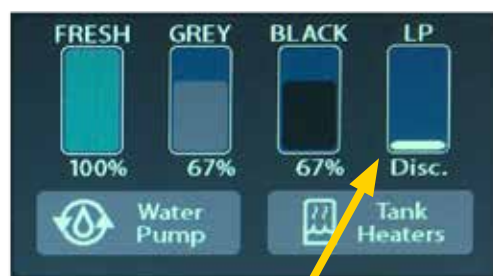

Multiplex touchscreen illustrating the tank monitoring display.

## General Instructions for Propane System

### DANGER

**DO NOT USE GAS COOKING APPLIANCES FOR COMFORT HEATING. CAN LEAD TO CARBON MONOXIDE POISONING, WHICH CAN CAUSE DEATH OR SEVERE INJURY.**

**DO NOT OPERATE GAS RANGES OR GAS COOKTOPS WHILE THE VEHICLE IS IN MOTION.**

**PREVENT ANY FLAMMABLE MATERIALS, SUCH AS CLOTHING, PAPER, OR CLOTH TOWELS, CURTAINS, OR SHADES FROM BECOMING CLOSE TO OPEN FLAMES OR HOT SURFACES.**

### WARNING

**GAS COOKING APPLIANCES NEED FRESH AIR FOR SAFE OPERATION. BEFORE OPERATING:**

- Open vents or windows slightly or turn on exhaust fan prior to using cooking appliance.
- Gas flames consume oxygen, which should be replaced to ensure proper combustion.

**IMPROPER USE CAN RESULT IN DEATH OR SEVERE INJURY.**

### WARNING

- **DO NOT STORE COMBUSTIBLE MATERIALS ON OR NEAR GAS APPLIANCES.**
- **RANGE COVERS MUST BE OPEN WHEN THE SURFACE BURNERS ARE IN OPERATION.**
- **IF YOUR MOTORHOME HAS A PRIVACY CURTAIN WITHIN 6 FEET OF THE GAS COOKTOP; DO NOT operate unless the privacy curtain is secured away from the appliance or removed.**

**MAY CAUSE A FIRE, WHICH COULD RESULT IN DEATH OR SEVERE INJURY.**

### WARNING

**STRICTLY FOLLOW ALL SAFETY INSTRUCTIONS WHEN USING LP GAS APPLIANCES AND THE LP GAS SYSTEM OF YOUR MOTORHOME. THE RISK OF FIRE AND/OR EXPLOSION AND BODILY INJURY EXISTS WITH IMPROPER USE OF LP GAS OR ANY OTHER FLAMMABLE SUBSTANCES.**

### **NOTICE**

Propane appliances, such as furnaces, water heaters and refrigerators, are equipped with automatic propane igniters, while some stove or oven models may require lighting a pilot light before operating the appliance.

*NOTE: For complete safety information, operating instructions and maintenance details, for any propane-related component of the propane system installed in your motorhome, please refer to the component manufacturer's owner's manual, included with your TMC Owner's Packet and available through your TMC Owners Resource account.*

## Main Gas Valve

The main gas valve is located on the propane tank. This valve controls the flow of propane to the propane system.



**IMPORTANT! When opening or closing the valve, it is important to only use hand pressure. The valve can be damaged if overtightened. DO NOT use wrenches or other torquing tools to open or close the main gas valve.**

Turning ON the propane gas:

1. Turn ON the master battery switch. Most, if not all gas appliances require 12 volts to operate igniters and other control circuitry.
2. Before opening the Main Gas Valve, ensure **ALL** burner valves, controls, and pilot light valves are CLOSED.
3. Open the main valve in the propane tank slowly to avoid a fast rush of propane vapor to the propane pressure regulator, which could cause propane 'freeze-up.' If propane freeze-up is suspected, close the main valve and wait 15 minutes before trying again.
4. Listen carefully as propane begins to flow. If a hissing noise is heard for more than one or two seconds, **THERE MAY BE A GAS LEAK!** Close the main gas valve and contact your selling dealer's service department to have the propane system tested.
5. Light or turn on the appliance(s) as needed, following the appliance manufacturer's operational and safety instructions.
6. Ensure that all gas appliances and the main gas valve is OFF before resuming travel.

Turning OFF the propane gas:

1. CLOSE and turn OFF all burner valves, controls, and pilot lights to all gas appliances and devices.
2. Turn OFF the main gas valve.

## Pilot Lights and Electronic Igniters

### **DANGER**

**TURN OFF ALL PILOT LIGHTS, APPLIANCES, AND THEIR IGNITERS (SEE OPERATING INSTRUCTIONS) WHILE THE MOTORHOME IS TRAVELING OR IN MOTION, AND BEFORE REFUELING THE MOTORHOME'S FUEL TANKS AND/OR PROPANE CONTAINERS.**

**CAN CAUSE IGNITION OF FLAMMABLE VAPORS, WHICH CAN LEAD TO A FIRE OR EXPLOSION AND RESULT IN DEATH OR SERIOUS INJURY.**

Nearly all of the gas appliances installed in your motorhome use electronic igniters, which eliminates the need for pilot lights. The furnace, water heater and if installed, the gas/electric refrigerator have automatic electronic igniters that ignite the propane gas when the appliance control systems require to do so.

However, some gas ranges and ovens have gas pilot lights and require manual lighting prior to use. The pilot light gas supply line will remain open as long as the pilot is lit and the thermocouple senses flame. If the pilot goes out, the pilot light has a safety device that will shut off gas flow to the pilot light. Follow the appliance manufacturer's instructions to light and extinguish the pilot.

Whether the ignition system is electronic or is a pilot, the main gas valve at the propane tank must be turned ON before operating any gas appliance. Refer to the appliance manual to determine whether a particular gas appliance in your motorhome has a pilot light or an automatic electronic gas igniter.

Electronic igniters and control circuitry of gas appliances operate on 12 volts DC, so in order to operate the furnace, water heater, and gas refrigerator, the master battery disconnect switch must be ON.

### Disabling Electronic Igniters

Electronic igniters are utilized in gas furnaces, water heaters, and gas refrigerators and all must be disabled whenever the motorhome is being refueled or the LP tank is being filled. Since electronic igniters operate on 12 volts DC, it is rather easy to disable electronic igniters when fueling the motorhome.

- Turn OFF the master battery disconnect switch to disable electronic igniters. **HOWEVER, THIS OPERATION WILL NOT TURN OFF PILOT LIGHTS. PILOT LIGHTS MUST BE MANUALLY TURNED OFF.**
- Always close the main gas valve on the LP tank before refueling the motorhome. Doing so will cut the gas supply to any lit pilot lights. The pilot light's thermocouple will ensure that inadvertent gas flow will not resume if the main gas valve is re-opened.

## Propane Cooktops and Ovens

### **WARNING**

Failure to follow safety warnings could result in fire, a burn hazard, possible explosion, carbon monoxide buildup, resulting in serious injury or death:

- Verify sufficient gas supply before attempting to light any burner. Air in the gas supply line will significantly delay burner ignition, and a burner may light unexpectedly as the air in the line clears out and is replaced by LP gas; this unexpected ignition may burn you. Air may be introduced into the supply line when the vehicle's propane tank is replaced, or during servicing of other gas appliances.
- In case of gas detection or other emergency, know where the main propane gas shutoff valve is located and know how to TURN OFF gas supply.
- Avoid negative draft or positive draft situations or the operation of this cooktop during excessively windy conditions. Negative draft caused by air moving across the cooktop may blow out the burner flame, resulting in carbon monoxide buildup, possible explosion, injury, or death.
- If any burner should extinguish (after initial lighting or due to accidental blow-out), turn all burner knobs to OFF and WAIT 5 MINUTES before attempting to re-light burner.
- All control knobs must be turned to OFF when not in use. Fire and/or burning hazard may occur if a burner is accidentally left ON.
- DO NOT operate burners with control knob set to the LITE position. Damage to the ignition module and burner electrodes may result.
- DO NOT operate range or cooktop if it is damaged or not working properly.
- DO NOT touch top burners, burner grates, or other areas near top burners during and after use. Do not let clothing or other flammable materials contact top burners or areas near top burners until they have had sufficient time to cool.
- Be sure that glass cooking utensils are safe for use on the cooktop. Due to sudden changes in temperatures, only certain kinds of glass utensils are suitable for surface or top burner use.
- Never leave burners unattended. A boil-over could result and cause smoking and greasy spillovers that could ignite.
- Turn pan handles inward, but not over other lit burners. This reduces the chance of burns due to bumping the pan or spilling hot contents.
- DO NOT leave children alone or unattended in area where range or cooktop is in use. Never allow anyone to sit, stand, or climb on any part of the range cooktop. They could be burned or injured.

- **DO NOT heat unopened containers; they could explode. The hot contents may cause burns and container particles may cause injury.**
- **Replace range cover only after burners and grate have sufficiently cooled.**
- **Burner flame should not extend beyond the edge of the cooking utensil. Extended flame could cause burns or fire.**
- **While operating the cooktop, frequently check the temperature of contents within cabinet areas above the cooktop. Do not store flammable or combustible material in cabinets above or adjacent to the cooktop.**
- **Because grease is flammable, never allow grease to collect around top burners or on the cooktop surface. Wipe up any grease spills immediately.**
- **Never use water on grease fires, and never pick up a flaming pan. Smother a flaming pan with a tight-fitting lid or cookie sheet. Flaming grease outside of the pan can be extinguished with baking soda or a multipurpose dry chemical or foam-type fire extinguisher.**
- **Use care when lighting a burner by hand. If the burner lights unexpectedly, or your hand is close to the burner, you may be burned.**
- **Keep cooktop area clear of combustible cleaning materials, flammable vapors, and liquids.**

Depending on brand and floor plan features, your TMC motorhome may be equipped with a gas cooktop or range (combined cooktop and oven), in a multi-burner configuration. Given the wide variety of cooktops that may be factory-installed, the following instructions are general in nature, and although the installed cooktop in your motorhome may look different than the following illustrations, it will operate in a similar fashion as described in this section.

Become familiar with all safety-related warnings and instructions whenever a propane appliance or device is in use. Routinely, check for gas leaks. If gas is detected, either by smell or by an alarm, know the safety and evacuation procedures. Any gas leaks have the potential of causing explosion or fire, resulting in severe injury or death. Always have gas leaks and appliance malfunctions repaired immediately by a qualified technician. Follow all safety labels affixed throughout your motorhome and included in the manufacturer's owner's manuals for all propane appliances.

Each appliance in your motorhome is warranted by its manufacturer. It is very important that you review ALL the literature provided in your TMC Owner's Packet. Fill out and mail any warranty registration cards as required by the appliance manufacturers.

*NOTE: Appliance models and features vary, depending on floor plan and available options.*

For detailed safety, operational, and maintenance instructions for the propane appliances installed in your motorhome, log-in to

your TMC Owners Resource account. There you will find instruction manuals for all the appliances and components installed in or on your TMC motorhome.

<https://www.thormotorcoach.com/owners/>

If you cannot locate the information you need in your Owners Resource account, please have the brand, model, and serial number of your specific appliance available before contacting your selling dealership or TMC Customer Care. For your convenience, many appliance manufacturers have their owner's manuals available for download from their respective websites.

## General Cooktop Operating Procedure

Ensure your propane tank is filled and the propane system is ready for operation:

1. Close ALL burner valves, controls and pilot light valves.
2. Open the main propane valve slowly (located on or near the propane tank) to avoid a fast rush of propane vapor, which could cause propane 'freeze-up.' If you experience propane freeze-up, close the main valve and wait 15 minutes before trying again.
3. Listen carefully as propane begins to flow. If a hissing noise is heard for more than a few seconds, close the main valve and contact your selling dealer's service department to have the propane system tested.
4. Rotate the burner knob to the light or ignite position.
5. Press or rotate the sparker button or knob to light the burner.
6. Adjust the flame and operate appliances as needed, always following the appliance manufacturer's instructions.
7. When finished using the appliance, rotate the burner knob to the OFF position and CLOSE the main propane valve at the propane tank.

Make sure to read and follow ALL requirements for safe handling and operating of appliances and the propane system.

### NOTES:

- *Some TMC diesel-engined Class C motorhomes feature propane-fueled generators. Operating a propane-fueled generator can deplete the propane fuel supply that may be needed for other gas appliances.*
- *Motorhome owners that have propane-fueled generators should closely monitor the level of available propane so that the furnace, water heater and other gas appliances will have an adequate supply of propane fuel.*
- *See Water Systems Section in this manual for Water Heater Information.*

## Gas Range and Oven Combination

Your motorhome may be equipped with a two or three-burner range and oven combination. This unit requires a pilot light to be lit in order to operate the oven. The oven is designed this way in order to reduce the possibility of unintended ignition.

### To Light the Oven Pilot

- Ensure that the LP gas supply is ON at the LP tank.
- Turn the oven control knob to the pilot position and push IN.
- Light the pilot with a match or lighter.
- Hold in the knob for at least 30 seconds until the pilot flame is well established.

### The Pilot Will Not Come ON

- Check to determine if the main gas valve is turned ON.
- Check that the LP tank is not empty.
- Check for blockage of the orifice, pilot assembly or pilot line.
- Check for kinks in the pilot gas line.

### Pilot Will Not Stay ON

- Hold oven knob, in the pilot position, for up to 30 seconds.
- Check gas supply; ensure the main valve is ON and there is LP in the tank.
- Confirm that thermocouple is fully inserted into the thermocouple holder.
- Pilot flame out of position; pilot flame is not engulfing thermocouple. Pilot assembly needs to be adjusted so that pilot flame is engulfing thermocouple.

*NOTE: The pilot gas line will remain open as long as the pilot is lit and the thermocouple senses flame. If the pilot goes out, a magnet will drop out and shut off gas flow to the pilot.*

### Oven Operation

- After the pilot is lit, rotate the oven control knob counter-clockwise to the desired temperature setting or to BROIL. The oven will pre-heat in approximately 15 minutes. For best results, always allow adequate time for the oven to come to temperature.
- To extinguish the oven burner, rotate the oven control knob clockwise to PILOT/PUSH/HOLD position. The oven burner will extinguish, but the pilot will remain lit.

### Using the Broiler

- Ensure the pilot is lit.
- Push and rotate the oven control knob to the BROIL position.
- Center the cookpan under the broiler flame. Move and turn food frequently for even browning and cooking.
- When cooking is complete, rotate the oven control knob clockwise to PILOT/PUSH/HOLD position.
- For complete oven shut-down push in the oven control knob and rotate clockwise to the OFF position. Pilot should extinguish. For safety, visually check to confirm that the pilot did, in fact, extinguish.

*NOTE: Cooktops and ovens are a source of heat. On hot days, heat from the range and/or oven may cause the cabin temperature to rise to uncomfortable levels.*

### Lighting the Top Burners Manually

1. All burner controls operate counter-clockwise and must be pressed inward to turn ON or LITE position. Do not attempt to light more than one burner at a time.
2. Immediately light the burner by holding a lit match or hand-held spark igniter designed for this purpose, near the burner ports.
3. To extinguish the top burner flame, turn the appropriate burner knob counterclockwise to OFF.

### Lighting Top Burners with Spark Igniters

1. Turn the appropriate burner knob counterclockwise to ON or LITE. Do not attempt to light more than one burner at a time.
2. Turn the SPARK knob clockwise one "click." If the burner fails to light, continue turning the SPARK knob clockwise until the burner ignites.
3. To extinguish the top burner flame, turn the appropriate burner knob clockwise to OFF.



Typical propane gas cooktop/range

### Lighting Top Burners with Electronic Ignition

1. Turn the appropriate burner knob counterclockwise to ON or LITE. This will automatically activate the ignition system, and all burners will begin to spark repeatedly. This is the “clicking” sound you will hear.
2. The burner will light within five seconds. Once the burner is lit, turn the knob counterclockwise to the desired setting.
3. To extinguish the top burner flame, turn the appropriate burner knob clockwise to OFF.
4. If 12 volts DC power is not available to the ignition module for any reason, top burners may be lit manually (see manual lighting instructions above).

### 2 or 3-burner Cooktops

The kitchen of your motorhome may be equipped with a 2 or 3-burner gas cooktop (similar to the illustration below), and instead of a gas oven, your kitchen may be equipped with either a microwave or a combination microwave/convection oven (see microwave oven section).

If equipped, the gas cooktop operates similarly to the gas range burners described previously. Please note all LP gas-related safety instructions when using this or any gas appliance.

#### To operate the gas cooktop

1. Confirm that all burner control knobs are in the OFF position.
2. Turn ON the main battery switch.
3. Turn the main gas valve ON.
4. If your Cooktop is equipped with a top-cover, lift the top-cover when operating the Cooktop.

#### Lighting the burner

All burner controls operate counterclockwise and must be pressed inward when turning to light. Do NOT attempt to light more than one burner at a time.

1. Select a burner and its corresponding control knob. Push the knob IN and turn counterclockwise to the HI position. The burner's ignition sparker will operate as long as the knob is pushed IN.
2. Once the burner is lit, release the knob and rotate to adjust the flame.
3. Watch the flame, not the knob, as you adjust the flame. When rapid heating is desired, the flame size should match the size of the cookware bottom. Flames larger than the cookware bottom will not heat any faster and may be hazardous, causing a risk of fire.
4. To light the Cooktop with a match, turn the knob counterclockwise and IMMEDIATELY hold a lit match near the burner.

### Manual ignition

In the event that the igniter fails to ignite the burner, it may be lit using a match or long-stem butane lighter.

1. Push IN and turn the burner control knob counterclockwise to the HI position.
2. Immediately strike and place a burning long-stem match or butane lighter near the burner to ignite the gas.
3. Rotate the burner control knob to adjust the flame to a desired level.
4. Repeat steps 1 and 2 to light the other burner, if required.

### Extinguishing the burner

To extinguish the burner, turn the knob to the “OFF” position to stop the flow of gas to the burner. Do not touch or place any objects on the grates until the cooktop has cooled.

#### If the flame goes out

1. Immediately turn the control knob to the OFF position
2. Wait at least 5 minutes and light the burner again.

### Control knob illumination

Press the Light Button (on the front panel, right of the burner control knobs) to turn ON/OFF the control knob lights. Both knobs will go ON or OFF together.

### Cooktop vents

Never block the vents (air openings) of the cooktop. They provide the air for the inlet and outlet that are necessary for the cooktop to keep cool and operate properly with correct combustion. Never cover the opening with aluminum foil or any other material. Vents are located along the rear, front, and bottom of the cooktop.

*NOTE: For complete safety information, operating instructions and maintenance details, for any propane-related component of the propane system installed in your motorhome, please refer to the component manufacturer's owner's manual, included with your TMC Owner's Packet and available through your TMC Owners Resource account.*



Typical  
2-burner gas  
cooktop

## Cooktop Care and Maintenance

### **NOTICE**

- **All cooktop surfaces, burner grates, and burners must be cool before cleaning or disassembling the cooktop.**
- **Clean all surfaces quickly after spills.**
- **Use warm soapy water only to clean the burner grates, burner box, painted surfaces, porcelain surfaces, stainless steel surfaces, and plastic items on your cooktop. Do not use gritty or acid-type cleaners. Do not use steel wool or abrasive cleaners, as they will damage your cooktop. Use only non-abrasive plastic scrubbing pads.**

#### Control knobs

The control knobs may be removed for easier cleaning. Make sure the knobs are in the OFF position and pull them straight off the stems for cleaning. The knobs can be washed with dish detergent and water. Make sure the insides of the knobs are dry before replacing onto the stems. Replace the knobs in the OFF position to ensure proper alignment.

#### Burner caps

Wipe burner caps with hot, soapy water and rinse with clean water. If needed, scour with a plastic scouring pad to remove burned-on food particles.

#### Burner heads

Wipe the burner heads routinely, especially after bad spillovers which could clog the burner openings. Wipe with hot, soapy water. Rinse with clean water. For more stubborn stains, use a brush with plastic bristles.

*NOTE: Do not use steel wool or scouring pads to clean the burner parts as these may clog the openings. The parts in the burner heads must be kept clean at all times for an even, unhampered flame. Clogged or dirty burner ports or electrodes will not allow the burner to operate properly.*

#### Burner grates

Grates should be washed in hot, soapy water and rinsed with clean water. To soften burned-on food, place grates in a solution containing 1/4 cup of household ammonia for several hours. Afterward, scrub grates with a plastic scouring pad soaked in hot, soapy water. Rinse well and dry.

## External Propane Hook-up Port

### **⚠ DANGER**

Only operate external LP gas appliances for their intended purpose. Follow all safety and operational instructions associated with the appliance. The risk of fire, explosion or severe bodily injury exists.

Propane available at this source is at normal and regulated operating pressure. NEVER bypass or defeat the gas regulator installed on the motorhome's propane system.

### **⚠ WARNING**

#### WHEN USING THE OUTDOOR COOKING AREA:

- The vehicle must be level and stabilized.
- **DO NOT** violate manufacturers' instructions on required clearances for cooking appliances during use.
- **DO NOT** store cooking appliances until cool to the touch.

**CAN LEAD TO A FIRE AND EXPLOSION AND RESULT IN DEATH OR SEVERE INJURY.**

### **⚠ WARNING**

The Auxiliary Propane Gas Hook-up is equipped with a manual LP gas shut-off valve, located near the quick-disconnect coupler.

- Always turn OFF this gas valve when this LP source is not in use.
- Ensure this shut-off valve is closed whenever connecting and disconnecting gas appliances to the external propane hook-up.
- As with the main gas valve, ensure this valve is in the OFF position when traveling.

### **⚠ CAUTION**

- **DO NOT** use an external grill or griddle underneath an extended awning or rain fly. Rising heat from the device could severely damage awning fabric, cause a fire, or cause severe injury.
- **DO NOT** use an external grill or griddle in close proximity to the motorhome or camper van. Heat from the device could cause severe damage to painted surfaces, graphics, or plastic components.
- Ensure that children and pets stay well away from any gas appliance in use or connected to the external propane hook-up.
- **DO NOT** use or operate appliances designed for outdoor use inside the motorhome.

**POTENTIAL INJURIES DUE TO TRIPS, FALLS, FLAME AND HEAT EXIST.**

## NOTICE

**Propane appliances may have built-in gas regulators that could make the device incompatible with this low-pressure propane source.**

TMC motorhomes are typically equipped with an external propane gas hook-up that allows LP connection to an outside-use-only gas appliance, such as a barbecue grill, deep fryer, or an outside space heater. When installed, this propane connection port can be found on a gas manifold, near the right-side rear of the motorhome or located behind a small service door, along the bottom edge of the motorhome's exterior.

This external propane gas hook-up is equipped with a quick-disconnect coupler and a manually actuated shut-off valve. Always connect the gas appliance or device to the coupler before opening the shut-off valve. Turn the valve **OFF** before disconnecting the gas appliance or device.



(Above) Typical external propane hook-up port. (Right) manual shut-off valve.



Although designed for a wide variety of outdoor LP uses, the External LP Hook-up port provides a particularly convenient LP connection source for a propane griddle.

The external propane gas hook-up is plumbed after the propane system's gas regulator, so the gas pressure at this gas port is low; on or about 11 inches water column (approximately 0.5 PSI). Refer to the manufacturer's instructions of the external gas appliance or device to determine the required operating gas pressure.

The gas device may also need to be fitted with the mating end of the quick-disconnect coupler. The device's manufacturer or your RV retailer should be able to provide hook-up coupler recommendations.

### Safe Use of the External LP Port



**IMPORTANT! FOLLOW ALL PROPANE GAS SAFETY WARNINGS ASSOCIATED WITH THIS PROPANE CONNECTION AND ALL EXTERNAL GAS APPLIANCES.**

- **WHEN USING EXTERNAL GAS DEVICES, BE EXTREMELY CAUTIOUS OF FIRE AND EXPLOSION HAZARDS THAT MAY BE PRESENT. ONLY USE DEVICES THAT ARE DESIGNED FOR USE OUTDOORS AND AT THE REGULATED GAS PRESSURES OF THE MOTORHOME'S PROPANE SYSTEM.**
- **ALWAYS TURN THE MAIN LP GAS VALVE OFF WHENEVER TRAVELING AND RE-FUELING; BOTH THE MOTORHOME'S ENGINE FUEL AND WHEN RE-FILLING THE LP TANK.**
- **NEVER BYPASS OR MODIFY THE FACTORY SET PRESSURE OF THE PROPANE REGULATOR OF THE MOTORHOME'S PROPANE SYSTEM.**
- **ALWAYS KEEP THE MANUAL SHUT-OFF GAS VALVE LOCATED ON THE EXTERNAL PROPANE HOOK-UP OFF WHEN THE PORT IS NOT IN USE.**
- **ALWAYS FOLLOW THE GAS APPLIANCE MANUFACTURER'S INSTRUCTIONS FOR SAFE OPERATION OF ALL GAS DEVICES.**
- **ALWAYS ENSURE THE QUICK DISCONNECT COUPLER SEATS PROPERLY INTO THE CONTAINMENT COLLAR BEFORE TURNING ON THE GAS VALVE. IMMEDIATELY STOP USING THIS LP CONNECTION IF LEAKING LP GAS IS DETECTED. DO NOT USE UNTIL PROPER REPAIRS HAVE BEEN MADE.**
- **KEEP ALL FLAMMABLE MATERIALS A SAFE DISTANCE AWAY FROM THE LP APPLIANCE WHEN IT IS IN USE AND DURING COOL-DOWN; INCLUDING AWNINGS AND OTHER FABRICS THAT MAY BE ATTACHED TO OR NEAR THE EXTERIOR OF THE MOTORHOME.**
- **KEEP THE LP APPLIANCE OR DEVICE ON FIRM, LEVEL GROUND AND AT A SAFE DISTANCE FROM THE MOTORHOME TO PREVENT HEAT-RELATED DAMAGE OR FIRE TO THE MOTORHOME. BE SURE ALL GAS SUPPLY HOSES ARE OUT OF PEDESTRIAN OR PET TRAFFIC PATHS. BE SURE TO WARN CHILDREN AND KEEP THEM AWAY FROM FLAMES AND HOT SURFACES.**
- **DO NOT USE AN EXTERNAL GAS APPLIANCE IF WEATHER CONDITIONS WOULD PRESENT A RISK OF**

**TIP-OVER, FLARE-UPS, OR OTHER UNSAFE OPERATING CONDITIONS.**

- **TURN OFF THE PROPANE GAS SUPPLY TO THE APPLIANCE WHEN THE APPLIANCE IS NOT IN USE. THIS EXTERNAL PROPANE HOOK-UP HAS ITS OWN MANUAL GAS SHUT-OFF VALVE, LOCATED DIRECTLY BEHIND THE QUICK DISCONNECT PORT.**
- **ENSURE THE EXTERNAL GAS APPLIANCE IS COMPLETELY COOL TO THE TOUCH BEFORE STOWING IT AWAY. THE STORAGE AREA OF YOUR MOTORHOME COULD BE DAMAGED OR WORSE, A FIRE COULD IGNITE IF A HOT APPLIANCE IS PLACED IN THE STORAGE AREA.**
- **NEVER OPERATE OR USE AN APPLIANCE THAT IS DESIGNED FOR OUT-OF-DOORS USE INSIDE THE MOTORHOME; EITHER AS A HEAT SOURCE, FOR FOOD PREPARATION, OR FOR ANY OTHER PURPOSE. THE RISK OF SUFFOCATION, FIRE, EXPLOSION, SEVERE INJURY AND DEATH EXISTS.**
- **ROUTINELY INSPECT ALL EXTERNAL GAS APPLIANCES, DEVICES, GAS SUPPLY HOSES, AND CONNECTIONS FOR LEAKS, CRACKS, OR OTHER DAMAGE. DO NOT USE THE GAS APPLIANCE IF IT NEEDS REPAIRS. ONLY USE THE GAS APPLIANCE AFTER PROPER REPAIRS HAVE BEEN MADE.**

To operate the external LP hook-up port:

1. Ensure **BOTH** the main gas valve and the manual shut-off valve, located on the LP hook-up port, are **OFF**.
2. Confirm the gas appliance is fitted with a proper gas hose and mating connector, and if so, connect it to the propane quick-release port.
3. Turn **ON** the main gas valve.
4. Slowly open the manual shut-off valve, listening to ensure there are no gas leaks.



**IF A GAS LEAK IS DETECTED, IMMEDIATELY CLOSE THE SHUT-OFF VALVE. DETERMINE AND REPAIR THE SOURCE OF THE LEAK.**

5. When safe to do so, operate the gas appliance.
6. After using the gas appliance, turn **OFF** the manual shut-off valve and disconnect the appliance from the port.
7. Allow the appliance to completely cool before stowing it away.

*NOTE: This propane port provides LP gas at about 0.5 PSI or 11 inches water column. Some gas appliances may have built-in gas regulators that could make the device incompatible with this low-pressure propane source. Always follow the appliance manufacturer's recommendations when modifying or removing LP gas regulators.*

## Propane System Leak Test

### **DANGER**

**PROPANE GAS IS HIGHLY VOLATILE AND EXTREMELY EXPLOSIVE. DO NOT USE MATCHES OR A FLAME TO TEST FOR LEAKS. USE ONLY APPROVED PROPANE GAS LEAK TESTING SOLUTIONS FOR LEAK DETECTION.**

Unapproved solutions can damage copper tubing and brass fittings. Never attempt to adjust propane gas regulators. Only qualified personnel should perform any maintenance or repair to the propane gas system.

If a propane gas leak is detected, close all gas valves and turn off all igniters.

Do not use any part or component of the propane system until the leak is properly repaired by a qualified technician.

When checking for gas leaks, always keep doors and windows open for ventilation. Eliminate and disable all sources and/or potential sources of ignition, such as open flames, smoking materials, electrical-induced sparks from switches and electric motors. Be sure all pilot lights are extinguished and that appliances that use electric igniters are disabled.

Be particularly diligent with inspecting propane hoses and piping that is exposed to weather elements. Hoses deteriorate over time and routinely need to be replaced. Gas lines and fittings that are exposed to weather and road elements are particularly susceptible to corrosion.

Leaks may be found easily with a soapy water solution. Do not use a solution containing ammonia or chlorine when searching for leaks. These products are corrosive to copper gas lines and brass fittings, which could result in deterioration of the copper and brass components.

#### Gas Leak Test Procedure:

1. Open all windows and non-motorized vents.
2. Open the main propane gas valve, located on or near the propane tank.
3. Apply the soapy solution to the outside of the gas piping fittings. If a leak is present, the soapy solution will 'bubble' at the leak point.
4. If a leak is detected, tighten the connection with two open end wrenches until bubbling stops. **DO NOT** over tighten or use excessive force.
5. If the leak persists, **CLOSE** the propane gas main valve, located on or near the propane tank and immediately contact your selling dealer's service department or qualified propane service representative to arrange repairs. **DO NOT** use the propane system or gas appliances until the leak is properly repaired.
6. To confirm the propane system is performing as designed, contact the motorhome dealer or a qualified propane service facility to perform an 11-inch water column pressure test.

*This page is intentionally blank*

## Freshwater System

Potable (drinking) water is supplied throughout the motor from either the freshwater holding tank or from a connection to an external water source. When using the freshwater holding tank, water is pressurized and travels through the water lines by means of the water pump. When utilizing an external water source, such as a campsite water spigot, the water pump is not needed (it is bypassed by check valves), as the campsite water source provides pressurized water to the motorhome.

## Potable Water Hose

To supply safe potable water to the motorhome, purchase and keep separate a sanitized water hose, whose sole function is for potable water delivery and freshwater tank filling. Use a different water hose for other water-related activities, such as cleaning outdoor furniture, washing the motorhome, maintenance, or sewer system cleanup.

## City Water Connection

### CAUTION

**Some external water sources develop high water pressure, particularly in mountainous regions. These campgrounds or hook-up locations may not have regulated water pressure, which could be considered excessive.**

**High water pressure is anything over 55 psi. Excessive pressure may cause leaks or damage to your motorhome's water system.**

### NOTICE

**When connected to an external water source, it is strongly recommended that a water pressure regulator is used in-line with the water supply delivery hose. Water pressure regulators are designed to reduce high external water supply pressures to a level that is safe for your motorhome's water system, preventing potential damage. RV water pressure regulators can be obtained at RV suppliers or dealers.**

1. Set the water heater bypass valves (if installed) to the correct position illustrated on the water system label. **DO NOT OPERATE THE WATER HEATER IF ITS WATER SUPPLY IS BYPASSED.**
2. Remove the cap from the freshwater inlet on the side of the motorhome.

3. Attach one end of a potable (drinking) water hose to the external water source spigot.
4. Connect the other end of the hose to the motorhome's city water inlet.
5. Turn ON the external water source spigot. Gradually open the hot and cold water at the sinks and shower to clear air from the lines. Close the faucets when the water is flowing freely.



Typical city water fill connection

## Disconnecting City Water Source

1. Turn OFF the external water source spigot.
2. Disconnect the potable water hose from the supply spigot and the freshwater inlet of the motorhome.
3. Reinstall the cap on the freshwater inlet.
4. Stow the water hose separately from wastewater hoses and other non-sanitary devices.

### NOTES:

- If you will be away from your motorhome for a few hours or more, it is a good practice to disconnect or turn off the valve from the city water source. This will prevent or reduce any damage that could be caused by a pressure-induced leak in the motorhome's water system pipes or fittings.
- The use of in-line water filters and pressure regulators (not supplied by TMC) is recommended whenever potable water is being delivered by an external source.
- Ask your dealer for details about these and other useful fresh and wastewater system devices and accessories designed to aid with your water system's operation and maintenance.

## Freshwater Holding Tank

### **⚠ WARNING**

**POTABLE WATER ONLY. SANITIZE, FLUSH, AND DRAIN FRESHWATER HOLDING TANK BEFORE USING.**

**Failure to maintain tank may result in death or severe injury.**

### **NOTICE**

**Do not leave the motorhome unattended while filling the freshwater holding tank. Although the freshwater holding tank has an overflow vent, incoming water volume may exceed the capacity of the overflow vent, creating excessive pressure within the water tank and possible damage to seals and fittings.**

Your motorhome is equipped with a freshwater holding tank. When an outside source of water is unavailable, freshwater can be drawn from this on-board source as long as there is a supply of water in the tank.

To fill the freshwater tank:

1. Set water heater bypass valves to the correct position illustrated on the water system label. **DO NOT OPERATE THE WATER HEATER IF ITS WATER SUPPLY IS BYPASSED.**
2. Remove the water fill cap.
3. Attach a potable water hose to the gravity fill inlet, while attaching the other end of the hose to a source of safe drinking water. Turn ON the valve at the water source. Only use a water hose designated for potable water purposes.
4. When the tank is full and water is coming out of the freshwater overflow tubes located underneath the motorhome or near the freshwater fill-port:
  - a. Stop filling the freshwater holding tank;
  - b. Replace the water fill cap.



Typical freshwater gravity fill. Some fill caps may be located behind a lockable access panel.

Drawing freshwater from the tank:

To use water from the freshwater holding tank, turn the water pump ON to pressurize the water in the lines and to the water heater. When ready, gradually open the hot and cold water at the sinks and tub to clear air from the lines. Close the faucets when the water is flowing freely.

When traveling, it is good practice to carry only enough freshwater to meet your needs until arriving at the next destination with a safe, potable water source. This will reduce the on-board water weight, potentially allowing carrying capacity for other cargo items. Refer to Section 6, Occupant and Cargo Carrying and Capacity (OCCC).

*NOTE: When connected to a pressurized city (external) water supply, the on-board freshwater holding tank and water pump are automatically bypassed by a system of check-valves. This prevents the freshwater tank from being overfilled, possibly damaged, or causing water leaks.*

*NOTE: While traveling, water can slosh in the freshwater holding tank and a small amount may escape through the overflow tube. This is a normal occurrence, and you should not be alarmed if you arrive at your destination with less freshwater than you expected.*

## Freshwater Holding Tank Drain Valve

### **NOTICE**

**When draining the entire on-board freshwater system, make sure to open faucets; then open the water heater drain valve, system low point drain valves, and the freshwater holding tank drain valve.**

The freshwater holding tank drain valve is a key component used in freshwater system maintenance. This drain valve is located near the freshwater holding tank and is usually identified by a red T-handle, which operates a ball-valve. Turn the handle 90 degrees to open and close the valve. The tank drain is plumbed through the floor.

In some installations, the freshwater holding tank drain valve is located externally, along the lower side of the motorhome.

Use this drain valve to lower or empty the volume of water in the freshwater holding tank. It has vents that facilitate pressure equalization when draining the tank. If water flow from the valve seems slow, check the tank vents for blockages.

Complete diagrams of the freshwater system installed in your TMC motorhome are available through your on-line TMC Owners Resource account. Look for a document with the floor plan designation and the word 'Schematic' in its title.

### Monitoring Holding Tank Levels

Typically, the holding tanks liquid level is monitored by a display located inside the motorhome, either as part of the Monitor Panel, or included on the multiplex system's touchscreen. Fresh and wastewater systems that feature remote monitoring will have a level sensor installed within the holding tank.

#### Monitor Panel Holding Tank Level Indicator

For TMC motorhomes without multiplex electrical systems, the holding tank levels, along with the LP tank level, are monitored by an array of four LEDs located on the Monitor Panel.

To operate:

1. Press and hold either the FRESH, BLACK, or GRAY holding tank switch.

NOTE: Motorhomes with cassette toilets do not have a black tank monitor.

2. One of the 4 LEDs in the array will illuminate, indicating the liquid level of the holding tank; from empty-to-full in 1/3 increments.
3. Read the holding tank level and release the switch.

Similarly, press and hold the corresponding LP tank switch to monitor propane tank fuel level (if equipped).

#### Multiplex Holding Tank Level Indicator

Motorhomes equipped with a multiplex control system will have holding tank level monitors, along with propane tank monitoring, as part of the user/interface touchscreen panel. Holding tank monitoring is usually located on the Home Menu screen, but it could be placed on other menu screens. As with the Monitor panel, the multiplex system also indicates tank levels, from empty-to-full, in 1/3 increments. The liquid level is monitored in real-time; so as long as the multiplex system's touchscreen is ON (main battery switch must also be ON), there is no need to press an additional button to read the level condition of the fresh, black, gray or propane holding tanks.

NOTE: Monitor displays installed in your motorhome may vary from these illustrations due to installed features and available equipment.

LED Condition Indicators

Press a corresponding holding tank switch. A LED will illuminate indicating the liquid level of the holding tank.



Monitor panel LED tank level display.



Multiplex touchscreen illustrating the tank monitoring display.

## Holding Tank Heaters

### **NOTICE**

- Operate holding tank heating pads only when the inside temperature of the motorhome is expected to reach 40° F (4° C) or below.
- Operate heating pads only if there is at least a small volume of fluid (a few gallons) in the holding tanks. Damage to the pads or bottom of the storage tanks could occur if fluid is not present.
- Holding tank heaters will not protect other water system components from freeze damage. To protect water lines and other components (if the water system is not winterized), operate the furnace when the inside temperature is expected to be below 40° F (4° C) and set the furnace to maintain at least 40° F (4° C) inside temperature. Open cabinets doors to allow warm air to circulate around plumbing pipes and fixtures.
- Holding tank heating pads operate on 12 volts DC. When operating the heating pads while NOT connected to a shore-power source, always be mindful of the power load that heating pads present to the on-board battery system.
- To prevent freeze damage to the water heater, either operate (turn on) the water heater or ensure the water heater's tank is drained when encountering outside temperatures at or below 32° F (0° C).
- The best method of preventing freeze damage to the water system is to winterize the water system.
- Freeze damage to the water system or any component of the water system is not covered under TMC's limited warranties or component manufacturer's warranties.

TMC motorhomes may be equipped with holding tank heaters. These devices are heat-pads installed underneath the tanks and are manually activated by a switch, usually located on the main monitor panel or multiplex main menu touch-panel. Activate holding tank heaters whenever encountering sub-freezing temperatures. Other TMC motorhomes may be designed with furnace heat ducting directed to the water storage bays, which is designed to effectively prevent freeze damage to the water storage tanks. Ask your dealer if your motorhome is equipped with supplemental water storage tank freeze protection.

## Water Pump

### **NOTICE**

- **DO NOT** turn the water pump ON if the freshwater holding tank is empty. Doing so could cause damage to the water pump.
- **DO NOT** turn ON the water pump when using water from an external source. Only run the water pump if using potable water stored in your freshwater tank.
- The water pump should be turned OFF when the motorhome is left unattended for any amount of time. This may help limit potential damage should something fail within the water system.

When drawing freshwater from the freshwater holding tank, 12-volts DC power to operate the water pump is required. Once turned ON at the monitor or multiplex or panel, the water pump (also known as an on-demand pump) will self-prime, pressurize the water lines, and provide water to the faucets, shower, and toilet. As long as the water pump switch is ON, and there is water in the freshwater holding tank, the pump will turn on and off automatically as water demand requires.

#### Operating the water pump:

The water pump is designed to operate automatically on an as-needed basis. Using the water pump continuously, such as leaving a faucet open for an excessive time-period or operating the water pump without water in the freshwater holding tank, will shorten its operational life and is not covered by warranty. The water pump has a check valve that prevents water from back-flowing into the freshwater holding tank.



**IMPORTANT! DO NOT** operate the water pump if the freshwater holding tank is dry or the motorhome is connected to a pressurized external water source.

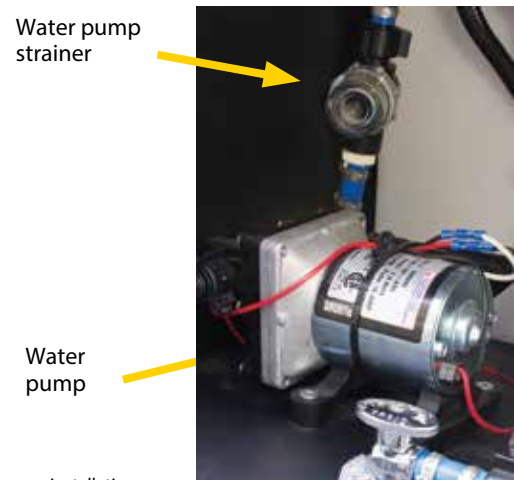

Typical water pump installation

1. Make sure there is adequate supply of water in the fresh-water holding tank.
2. Be sure the water heater bypass valves are set correctly according to the water system label. **DO NOT OPERATE THE WATER HEATER IF ITS WATER SUPPLY IS BYPASSED.**
3. Open all the faucets (first hot, then cold) including interior and exterior shower faucets.
4. Turn the pump switch ON and allow the water pump to fill the water lines and hot water heater tank (if installed). After water is flowing in a steady stream from all faucets, turn the faucets OFF. The water pump should stop operation automatically when all faucets are closed. The pump should now run 'on-demand' when a faucet is opened and stop when the faucet is closed.
5. The water pump switch must be ON to provide water to the toilet.

The switch for the water pump is usually located on the Monitor Panel or Multiplex Main Control Panel (if equipped). Refer to Electrical System Section.

For additional information on the care and operation of the water pump, refer to the water pump manufacturer's information.

## Water Pump Strainer

If equipped, periodically check the in-line water pump strainer for accumulated debris. To clean the water pump strainer shut OFF the water pump, unscrew the clear cap, remove the reusable metal cartridge, clear any debris, and reinstall the strainer and cap.

## Water Systems Panel

Select Class A motorhome models are equipped with a water systems panel, which includes the features listed below. However, if your motorhome is not fitted with a water systems panel, it will include most, if not all features depicted, just located in other areas of the motorhome. Water systems may include:

- Valve panel
- Freshwater inlet
- Freshwater filter
- External shower
- Low point drains
- Water pump switch
- Black tank flush
- Compartment light

*NOTE: Your dealer or TMC Customer Care representative can assist you in locating water system features of your motorhome. Freshwater system diagrams are available through your TMC Owners Resource on-line account and are included in the Schematic Diagrams set for your motorhome.*



Water system panel for a Class A motorhome.

## Valve Panels

### ⚠ CAUTION

**Read all cautionary instructions and statements supplied by the manufacturer before performing any operations or functions of water valve.**

All TMC Class A diesel and several TMC Class A Gas and premium Class C motorhomes feature Valve Panels from either Anderson or Nautilus installed as part of the motorhome's water system.

Typically, valve panels feature an inlet port for city water and valve levers that facilitate freshwater source selections, fresh tank fill, sanitizing, and winterizing operations.

## Anderson Kantleak™ Water Valves

Most Anderson valve panels provide four convenient functions:

- **NORMAL:** Supply water to the fixtures from the freshwater tank (via pump).
- **CITY:** Supply water to the fixtures directly from an external water hook-up.
- **TANK:** Fill the on-board freshwater holding tank from an external water hook-up.
- **SANITIZE / WINTERIZE:** Supply sanitizing/winterizing solution to the fixtures from the inlet connection (via on-board water pump).



Anderson Model MAN102W Water Valve

## Nautilus Water Valves

The Nautilus P2.5 Panel System will allow the user to perform the following functions:

- Power fill your freshwater tank for remote or dry camping.
- Use your pump to supply water to fixtures from freshwater tank.
- Use your pump to siphon fill or sanitize your freshwater tank from a bucket.
- Connect to city water at the camping site to supply water to fixtures.
- Winterize your plumbing lines and fixtures.
- Rinse black tank to help control odors and prevent sewage buildup.
- Connect up to three (3) coax lines with satellite, cable and auxiliary.

### The Green Handle

Receives water from water inlet on front of panel.

- **Sideways:** water goes from inlet to pump.
- **Down:** water goes to freshwater tank.

### The Blue Handle

Receives water from the white handle valve/water inlet on front of panel.

- **Sideways:** water goes to fixtures (cold.)
- **Down:** water goes to or come from freshwater tank

*NOTE: Detailed instructions for valve panels are not included in this manual. For Valve Panel information, along with details about the water system installed in your motorhome, please refer to the TMC Water Systems Guide, available to view or download from your TMC Owners Resource document service account.*



Nautilus Model P2.5 Water Valve

## Freshwater Filter

TMC motorhomes may be equipped with a cartridge-type freshwater filter. Periodically, the filter cartridge will need to be replaced. Also, when sanitizing or winterizing the water system, be sure to follow the guidelines specified for the water filter. Water system diagrams are included as part of the schematic set for your motorhome, available through your TMC Owners Resource account.



Typical Freshwater Filter

*NOTE: TMC motorhomes may be prepped for an easy dealer or DIY water filter installation. If equipped, connections for this purpose are usually located underneath the kitchen or bathroom sink.*

## Exterior Shower and Spray Port

### ⚠ CAUTION

**Outside shower and spray ports are not intended as a freshwater drinking source.**

Select TMC Class A and C motorhomes are outfitted with either an external shower or water spray port. External showers include both hot and cold running water while the spray port is connected to the cold water supply.

With a quick-connect connection, the freshwater port provides convenient access to a pressurized water jet for light-duty cleaning of camp gear, hiking shoes, and other items. The external shower includes a shower wand and hose designed to facilitate a variety of camp clean-up duties.



## Water Heaters: Tank Type

### DANGER

Turn OFF all pilot lights, appliances, and their igniters (see operating instructions) while the motorhome is traveling or in motion, and before refueling the motorhome's fuel tanks and/or propane containers. Close the propane supply valve at the propane tank.

Can cause ignition of flammable vapors, which can lead to a fire or explosion and result in death or severe injury.

### WARNING

#### SCALDING INJURY

Turn off water heater and allow time for the water to cool before removing the drain plug to either drain or flush the water heater's holding tank.

### WARNING

- NEVER operate the water heater with an empty supply tank. Always ensure the freshwater system is pressurized, either by the system's water pump or by connecting to a pressurized city water supply.
- Chemical reactions within the water heater can produce Hydrogen Gas - DO NOT smoke or have an open flame near an open faucet.

Your motorhome will be equipped with one of these three types of water heaters:

- Tank-type (6 and 10 gallon);
- Tankless (on-demand);
- Hydronic (on-demand).

Typical tank-type water heaters have a propane-fired heating source and require 12-volt DC for the control circuitry. The switch for turning ON and OFF the water heater is located on the Main Monitor Panel or Main Menu of the Multiplex Control Panel.



#### DO NOT OPERATE THE WATER HEATER:

- IF THE WATER INLET IS BYPASSED;
- IF THE WATER HEATER'S TANK IS EMPTY;
- IF THE WATER SYSTEM IS WINTERIZED; OR,
- WHEN FUELING THE MOTORHOME.

To operate a typical tank-type water heater:

1. Ensure the bypass valves are closed and there is a pressurized supply of water flowing to the water heater.
2. Open the main gas valve, located on the propane tank.
3. Turn ON the water heater switch, which supplies electrical power to the water heater's control circuitry.  
The control circuitry will turn on and off the gas burner depending on the temperature of the water in the water heater's holding tank.
4. The water temperature is preset at the factory. Allow adequate time for the gas burner to heat the water within the water heater's supply tank (typically 20-30 minutes). When the water in the supply tank reaches its set temperature, the gas burner will automatically turn off.
5. Open the hot water faucets to use hot water. Adjust to desired temperature by mixing with the cold water faucet.  
As the water in the supply tank cools or is replaced, the gas burner will automatically cycle on and off to maintain the set water temperature.
6. Some water heater models feature an auxiliary electric heating element, typically operating on 120-volts AC. This electric element aids in hot water recovery.

Since the typical RV water heater's capacity is significantly smaller than a home water heater, users should observe frugal hot water use. A few days on the road will give travelers a good baseline for the on-board hot water capacity.

*NOTE: For complete safety information and operational instructions for the water heater installed in your motorhome, please refer to the water heater manufacturer's guide contained in your Owner's Packet or visit the water heater manufacturer's website.*

*For information pertaining to your motorhome's systems or components, contact TMC Customer Care or refer to the information available from your TMC on-line Owners Resource account.*

## Water Heaters: Tankless

### **⚠ WARNING**

- **NEVER** travel with the water heater **ON**. Before traveling, always turn the main switch to the water heater **OFF** and close the propane supply valve at the propane tank.
- Traveling with the main propane valve **OFF** will help prevent propane gas leaks in the event that the motorhome is involved in a vehicular accident.
- Turn **OFF** the water heater and all other igniters when fueling the vehicle or re-filling the propane tank.

### **⚠ WARNING**

**IT IS DANGEROUS TO OPERATE A TANKLESS WATER HEATER UNATTENDED.**

Damage may occur if a sufficient leak develops in the water system or if a faucet is left open. For this reason, the tankless water heater installed in this motorhome will turn off after operating for 20 minutes and displays **ERROR "En"** on the display.

### **NOTICE**

Water heater control circuitry operates on 12 volts DC. The main battery switch must be **ON** and the main gas valve must be **ON** for the water heater to operate.

**Some tankless water heater systems do not include bypass valves. Refer to the manufacturer's instructions regarding the introduction of sanitizing and winterizing chemicals to the water heater and its components.**

**Girard and Suburban tankless water heaters use a similar controller. The following directions apply to both systems.**

With a tankless, or on-demand water heater, water is heated as it flows through a propane-fired heat exchanger, which is set to a specified temperature by a user-controlled panel. By eliminating the need for a hot water storage tank, the user can enjoy instantaneous hot water, without waiting. Water is only heated when water flows through the heat exchange coils, triggered by the opening of a hot water faucet. If the water temperature is set correctly on the controller, there is no need to mix hot and cold water at the faucet to adjust for desired water temperature. An automatically controlled electronic igniter is used to ignite the propane gas as needed.

The tankless water heater is controlled from the User Control Panel (UCP), which includes the power ON/OFF switch. This water heater can be operated in two different ways:

1. Like a conventional tank-type water heater; the user sets the temperature, usually 115° F, turns on the hot water and adds cold water to achieve the desired warm water temperature mix.



Tankless water heater User Control Panel (UCP) mounted on a bathroom wall

2. Select the desired temperature by adjusting temperature settings up or down. The UCP settings are from 95° F to 124° F. The unit will maintain the set temperature. Simply set the desired hot water temperature and only open the hot water faucet; no mixing with cold water required.

Note: The recommended factory setting is 115° F (46° C).

#### Normal operation:

1. Turn **ON** the power. The panel will light and will display the current temperature at the inlet of the unit.
2. Press one of the temperature selection arrows (up or down) to see the current set temperature.
3. If needed, adjust the set temperature to the user's preference (95° F to 124° F) (35° C to 51° C).
4. Turn on the hot water faucet.
5. As long as a hot water faucet is opened, water from the fresh-water tank or a city supply will flow into the water heater's heat exchanger and will be heated to the set temperature and flow to the open faucet.
6. The main gas valve must be on for the water heater to operate. Gas ignition will cycle on and off automatically with the demand for hot water.

## Anti-Freezing Protection

### **NOTICE**

**For the Antifreezing Device to operate, there must be a sufficient LP gas supply and 12 volts DC power available. The unit's ON/OFF switch must be in the ON position whenever freezing temperatures may occur. The antifreezing feature will NOT protect other components of the water system.**

To protect the tankless water heater from potential freeze-related damage, the unit has a built-in thermostat that will start the burner whenever the temperature of the Heat Exchanger falls below 38° F (3.3° C) and will automatically shut off when it senses a temperature in excess of 58° F (14.4° C). Refer to the manufacturer's operational guide for details.

#### Maintenance:

The manufacturer recommends monthly inspections of the water heater by the user and annual inspections by a qualified service technician. A routine inspection includes:

1. Inspect the integrity of the sealing (caulking or tape) between the side wall and the door of the water heater and ensure that the unit is solidly mounted to the vehicle.
2. Verify that the air inlet openings (louvers) are completely open and clear of any debris including mud, leaves, twigs, insects etc. Remove all obstructions to allow full air flow.
3. Insects, including mud wasps and spiders, can build nests in the Exhaust Tube Outlet which will affect the performance of the unit. Inspect the Flue Outlet Tube to make sure that it is unobstructed and that the screen is clean. If debris or insects are present, clean and vacuum to remove all debris. The use of any type of after-market screen to cover the vent is not permitted and will void the warranty.
4. Open the door and verify that no debris or extraneous combustible materials are present anywhere (especially in and around the burner and the gas controls); remove any item present and wipe the bottom of the housing clean.
5. Inspect the interior surface of the housing for any cracks or corroded areas that could allow penetration of gases into or out of the interior of the vehicle. Check especially around the hot water, cold water, gas, and electrical connections.
6. There is a filter screen on the water heater inlet water line connection, unscrew the water line connection from water inlet and check the screen to ensure no debris is present.
7. Check that all wire connections are firmly in place and there are no signs of chafing or cracks on the insulation. Verify that the spark ignition cable between the control board and the igniter is securely in place and not shorted to any metal component.
8. Check relief valve to ensure it has not been leaking.
9. Turn ON the power to the water heater and open a hot water faucet to inspect the flame of the burner. The flame should be of the normal bluish appearance that indicates proper combustion. This can be accomplished by opening the water heater door and observing the flames by looking at the burner under the edge of the heat exchanger.
10. If unit overheats often and the relief valve discharges periodically, contact your service center for repairs.

#### Winterizing:

Frozen water within the water heater and its plumbing components will result in severe damage and is not covered by the manufacturer's warranty. For this reason, it is advisable to follow the recommendations below if the motorhome is to be stored in a freezing environment or when freezing temperatures may be encountered during travel.

At the start of the winter season or before traveling to a location where freezing conditions are likely, the unit must be winterized. The very small amount of water present in the heat exchanger **DOES NOT** require the installation of a bypass kit. Winterize the water heater by following either of these methods recommended by the manufacturer:

- Compressed air method: drain all water from the system opening one tap at a time and using compressed air to purge all remaining water.
- Anti-freeze method: Follow the water system winterizing instructions located in this manual. **DO NOT** bypass the tankless water heater. Only use non-toxic antifreeze that is specifically formulated for RV water systems. Make sure that the anti-freeze flows from each tap to complete the process.

Information courtesy of LCI Industries.

## Hydronic Heating Systems

Select TMC Class A and Class C motorhomes are equipped with hydronic heating systems that provide dual functionality:

- Interior heating system: Provides quiet, comfortable interior heat and zoned temperature control.
- Tankless hot water system: Provides a steady flow of continuous hot water.

Please refer to the Hydronic Heating Systems information located in this manual.

## Troubleshooting All Water Heater Types

- **Will not ignite:** Verify that the power switch is turned ON at the control panel.
- **Will not ignite:** Verify that the 120VAC circuit breaker (if equipped) is turned ON and not tripped.
- **Will not ignite:** Verify that the gas supply is not empty and the main gas valve is OPEN.
- **Will not ignite:** Check the main battery disconnect switch; it must be ON.
- **No hot water:** Verify the city water connection and the water source is turned ON to supply water.
- **No hot water:** Verify that the fresh tank has water and the water pump is turned ON to supply water.
- **No hot water:** Verify that the water heater bypass valves are in NORMAL mode to allow a supply of water.
- **On Suburban tank-type water heaters:**
  - Check the gas and 120VAC reset buttons to determine if tripped from high temperature.
  - Check rocker switch behind gas valve.

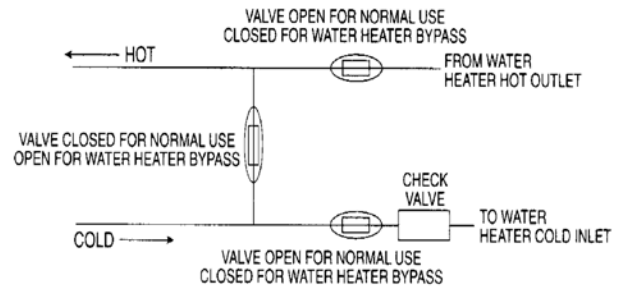

Water Heater Bypass Valve diagram

To bypass the water heater:

1. Close the valves leading to the cold water inlet and hot water outlet of the water heater.
2. Open the valve between the hot and cold water lines.

When the water heater is bypassed for winterizing, be sure to remove the drain plug and drain the water heater's tank. Refer to the manufacturer's instructions for long term storage and winterizing procedures.

When water system sanitizing activities are completed or when placing the water heater back into service, return the bypass valves to their normal positions so that the water heater will have a fresh and replenishing supply of water for normal operations.

## Water Heater Bypass Valves

### **⚠ WARNING**

**NEVER OPERATE A WATER HEATER IF ITS WATER SUPPLY SHUT-OFF OR BYPASSED. SEVERE DAMAGE TO THE WATER HEATER WILL RESULT, ALONG WITH A RISK OF FIRE.**

### **NOTICE**

**Tankless water heater installations may not include bypass valves. Review the manufacturer's instructions regarding any cautionary statements they may have concerned with the introduction of sanitizing and winterizing chemicals to the water heater and its components.**

A water heater bypass valve system may be installed inside your motorhome, usually behind the water heater, in a cabinet or maintenance access area. Bypass valves are used for water heater maintenance operations or when the manufacturer of the water heater cautions against introducing sanitizing and winterizing chemicals to the water heater and its components (see Sanitizing and Winterizing sections of this manual).

## Low Point Drain Valves

Low point drain valves are used to drain the freshwater system whenever maintenance, sanitizing, or winterizing is required. The valves are installed in at the lowest point of the water system, thus providing a complete freshwater system evacuation. The valves allow draining the hot and cold water lines. Usually, the freshwater holding tank has a separate drain valve.

For many water system installations, the lowest point of the hot and cold water lines is a water feature, such as an external shower or spray port. Freshwater system diagrams indicate the location of all drain valves.

Low point drains will not evacuate water trapped within the water heater tank. Water heaters typically have separate drains, consisting of a drain plug of some type. Refer to the water heater's manufacturer's instructions for draining procedures.



Typical low-point drain valves

## The Water System in Cold Weather

### CAUTION

**Always be very cautious when using the motorhome's water system in cold weather. Freezing water can severely damage water system components.**

**Take actions to prevent freezing water damage to pipes, plumbing, and other water system components.**

Many owners choose to use their motorhomes throughout the entire year or encounter freezing temperatures during travel. Due to the risk of severe damage, prolonged use of the water system in severely cold weather is not recommended. However, winter traveling can be safe for your motorhome's water system if you follow a few precautions.

- To avoid damage caused by freezing, the water system and storage tanks of your motorhome are dependent on the ambient temperature of the motorhome remaining above 32° F (0° C). When fully functioning and the temperature is set properly, the furnace will provide enough heat to protect the water system. In severe cold however, it is wise to monitor the water temperature in the tank and take appropriate steps to drain and winterize if necessary. In weather below freezing, it may be necessary to open the lower cabinet doors at night in both the bath and kitchen areas to keep warmer air circulating around the water pipes, drainpipes, and fixtures. Always ensure you have an adequate supply of LP fuel to keep the furnace operational and regularly test your CO/LP detector to ensure breathable air inside the motorhome remains safe.
- If your motorhome is left unheated for any length of time during cold weather conditions, you must winterize the water system. This includes draining the holding tanks, water supply lines, and water heater. Use RV antifreeze to protect water lines and drainpipes that may still contain water. Refer to the water system winterizing procedures outlined in this manual.
- In cold weather conditions, it may be best to carry cooking and drinking water with you in plastic bottles or jugs instead of using the on-board freshwater system. If you decide to use bottled water, be cautious of water being placed down drains or being flushed through the toilet. Water that remains in P-traps and holding tanks is susceptible to freezing. If available, use campground bathhouse facilities.

*NOTE: Cold weather additives to on-board propane will ensure proper operation of your furnace, water heater and other gas appliances. Consult with your propane dealer about the anti-freezing properties of the propane you purchase.*

## Sanitizing the Freshwater System

### CAUTION

**WHEN USING CHLORINE, FOLLOW THE CAUTIONS ON THE BOTTLE LABEL:**

- Chlorine is poisonous to humans and animals. Keep children and pets away from area when performing sanitizing procedures.
- Chlorine may burn skin. Use rubber gloves.
- Use safety glasses or face shield to protect eyes from material splashing.
- Chlorine splashed onto clothing can fade colors.

### CAUTION

- Chlorine solutions may damage components of some water heaters and heat exchangers. It is recommended to bypass the water heater when sanitizing the freshwater system.
- Chlorine solutions may damage the filtration cartridge of some water filters and/or water treatment devices. Bypass water filters, or remove filter cartridges prior to sanitizing treatment, or replace filter cartridge when sanitizing procedure is completed.

### **NOTICE**

**DO NOT CONNECT YOUR WATER SUPPLY HOSE TO THE CITY WATER PORT OF YOUR MOTORHOME WHILE PERFORMING THIS PROCEDURE. The freshwater holding tank could be bypassed, preventing proper sanitizing and flushing of the freshwater system.**

**Be sure to only use a diluted chlorine solution as a sanitizer and flush the water system thoroughly. Recap bottle and clean-up any utensils or appliances with soap and water.**

It is vital to regularly sanitize the freshwater system of your motorhome. This procedure will help keep the water system fresh and the water supply safe for drinking, while discouraging the growth of viral and bacterial contamination.



**IMPORTANT! THE FRESHWATER SYSTEM MUST BE SANITIZED AND DISINFECTED:**

- **Upon delivery of the motorhome;**
- **At least once per year during continuous use;**
- **Prior to using the motorhome after it has been unused for prolonged periods of time;**
- **And, if you suspect the freshwater system has been contaminated in any way.**

**DO NOT POUR BLEACH STRAIGHT INTO THE FRESH-WATER HOLDING TANK.** Chlorine bleach must be diluted with clean, freshwater before it can be used as a safe sanitizing agent.

Prepare a solution of 1/4 cup household liquid chlorine bleach (5% sodium hypochlorite) to one gallon of water for every 15 gallons of tank capacity.

*Examples:*

- Prepare 2-2/3 gallons of solution for a 40 gallon tank
- Prepare 3-1/3 gallons of solution for a 50 gallon tank
- Prepare 5-1/3 gallons of solution for an 80 gallon tank
- Prepare 6-2/3 gallons of solution for an 100 gallon tank

This mixture creates a 50 PPM (parts per million) residual chlorine concentration for the sanitizing process. This will act as quick-kill dosage for some harmful bacteria, viruses, and slime-forming organisms. Concentrations higher than 50 PPM may damage water lines and/or tank.

## Sanitizing Procedure

1. Turn off the water heater at the main switch and close the LP tank valve.
2. If bypass valves are installed, bypass the water heater. **CHLORINE CAN DAMAGE WATER HEATER COMPONENTS!**
3. Open all faucets and drain the freshwater holding tank by opening the tank drain valve. Close all faucets and the tank drain valve after the freshwater tank is empty.
4. With the fresh tank empty and all faucets and drains closed, pour the sanitizing solution into the freshwater holding tank via the gravity fill port. Be sure to add the proper amount of solution, depending on the size of your freshwater holding tank.
5. Top-off (completely fill) the freshwater holding tank.
6. Turn on the pump switch. Open all faucets (cold and hot) until the air is purged and water flows freely.
7. Close all faucets and top-off the freshwater holding tank again. **Allow the system to stand undisturbed for at least 3 hours.**

*After the time-period has ended:*

8. Drain and flush the entire system by opening all faucets, the freshwater tank drain valve and the low point drain valves, while running the water pump **AND adding potable water through the freshwater gravity fill port.**

**BE SURE THERE IS A CONTINUOUS SUPPLY OF FRESH, POTABLE WATER FLOWING INTO THE GRAVITY FILL PORT WHILE PERFORMING THIS FLUSHING PROCESS.**

9. Continue this flushing process for several minutes and until the chlorine odor is not detected at the faucets.
10. Close all drain valves and faucets and fill the freshwater tank as you normally would. Make sure the water system is purged of air.
11. If chlorine is still detected, repeat steps 7, 8 and 9.
12. Finally, close the water heater bypass valve(s) and confirm that the water heater's storage tank is full before turning on the water heater.

## Winterizing the Water System

### WARNING

**Automotive antifreeze (ethylene glycol) and windshield washer antifreeze (methanol) are poisonous. NEVER use these products in your freshwater system. These products are harmful and may be fatal if swallowed.**

**Only use biodegradable RV antifreeze to winterize your motorhome's freshwater system.**

### CAUTION

**DO NOT operate the water heater or use the motorhome's plumbing system after the water system has been winterized.**

### **NOTICE**

**Antifreeze can be damaging to internal components of the water heater. For proper water heater winterizing, drain the water heater tank and bypass the water heater inlet before adding antifreeze to the freshwater system.**

Properly preparing for colder weather or storage is an extremely important part of routine motorhome maintenance. The motorhome should be winterized at the end of the camping season, or when exposed freezing and below freezing temperatures (32°F; 0°C). Repairs due to freezing liquids are not covered by warranty. Add only RV antifreeze to the freshwater system to ensure freeze protection.

1. Level the motorhome and drain the freshwater system.
  - a. Locate and OPEN the drain valve for the freshwater holding tank.
  - b. Locate and OPEN the low point drain valves for both the hot and cold water lines.

NOTE: Low point drains may be water features such as exterior showers or spray ports.

2. Remove or by-pass the potable (drinking) water filter (if equipped).
3. Disconnect and cap (or by-pass) the:
  - Refrigerator ice maker inlet water line (if equipped);
  - Dishwasher inlet line (if equipped);
  - Clothes washer inlet line (if equipped);
  - If the motorhome has a dishwasher, ice maker, or clothes washer, follow the appropriate appliance manufacturer's instructions pertaining to winterizing (and de-winterizing).
4. Turn OFF all water heater power switches. Some water heaters have both 12-volt DC and 120-volt AC heating elements.
5. Turn OFF the gas valve at the water heater or turn off the power to tankless water heater (if equipped).
6. Turn the water heater bypass valves (if equipped) to the BYPASS or WINTERIZE position. Tankless water heater installations may not include bypass valves.  
**DO NOT** allow antifreeze to enter the water heater; it can damage water heater components
7. Drain the water heater tank. CAUTION: water may be HOT.
8. Close the freshwater holding tank drain valve and both low point drains valves.
9. Attach a short length of water hose to the city water fill (6 to 8 foot) and insert the other end of the hose into a gallon container of RV antifreeze (this quantity should be enough to winterize the motorhome). To assist the siphoning process, place the container on an object so that it is approximately two feet above ground level.  
  
NOTE: Typically, TMC motorhomes have a Winterization (Antifreeze) Port installed as part of the freshwater plumbing system. If your motorhome has such a port, connect the siphon hose to this port instead of the city water fill.  
  
NOTE: If your motorhome is equipped with an Anderson or Nautilus valve panel, make your syphon connection here.  
  
Refer to the freshwater system plumbing diagrams, included in your motorhome's Schematics document, available through your TMC Owners Resource account, to determine the location of the winterization fill port (if installed, this port is usually located near the water pump).
  - a. Remove the Winterization Port plug (or cap).
  - b. Attach the siphon hose, fitted with a threaded adapter to match the fill port threaded connector.
  - c. If installed, open the valve that is in-line with this port.
10. Turn the water pump ON. If the water pump fails to self-prime, temporarily open the low point drains. Close the low point

drains as soon as the water pump primes (RV antifreeze will begin draining out), and before continuing to the next step.

11. Open hot water faucets one at a time, beginning with the faucet furthest away from the water pump, until RV antifreeze begins to steadily flow out (kitchen, lavatory, shower, clothes washer, exterior shower and spray ports). Then, close the faucet. Repeat for each hot water faucet.
12. Perform the previous step with all interior and exterior cold water faucets and spray ports.  
  
NOTE: Allow enough antifreeze to flow so that the drain traps are filled with antifreeze.
13. Pour a cup-full of antifreeze down the shower drain.
14. Flush the toilet a few times until antifreeze appears in the bowl.

*When adding RV antifreeze is finished:*

15. Remove the hose from the city water fill port.
16. To prevent staining, wipe the RV antifreeze out of the sinks, shower, and toilet using a soft, dry cloth.

## De-Winterizing the Motorhome

1. Drain the holding tanks (fresh, gray, and wastewater tanks).  
  
NOTE: If you do not have access to a sewage inlet, only drain the fresh and gray holding tanks. **DO NOT** drain the black holding tank onto the ground.
2. Open the low point drain valves and drain the water lines of antifreeze. Opening a hot and cold faucet will help drain the water lines more effectively.
3. Close the low point drain valves and all holding tank drain valves.
4. Attach a potable water hose to the freshwater fill inlet and fill the freshwater holding tank.
5. Turn ON the water pump switch and open the cold water side of all faucets and shower fixtures. Shut OFF the faucet and shower fixtures after the water runs clear (no pink residue) and repeat for the hot water side.
6. Flush the toilet until clear water runs into bowl.
7. Empty the holding tanks again.
8. Sanitize the freshwater system.
9. If a potable (drinking) water filter has been installed: drain the water lines, remove the assembly, clean and reinstall using a new potable (drinking) water filter cartridge.
10. When ready to use the water heater, open the bypass valve allow water to enter and fill the water heater tank. The water heater bypass valve must NOT be in the BYPASS position for normal water heater operation.

NOTES:

- Although RV antifreeze is biodegradable, consider using a catch basin under the low point drain and freshwater holding tank outlets to collect and properly dispose of used antifreeze solution.
- Your dealer or TMC Customer Care representative can assist you in locating water system features of your motorhome. Freshwater system diagrams are available through your TMC Owners Resource on-line account and are included in the Schematic Diagrams set for your motorhome.

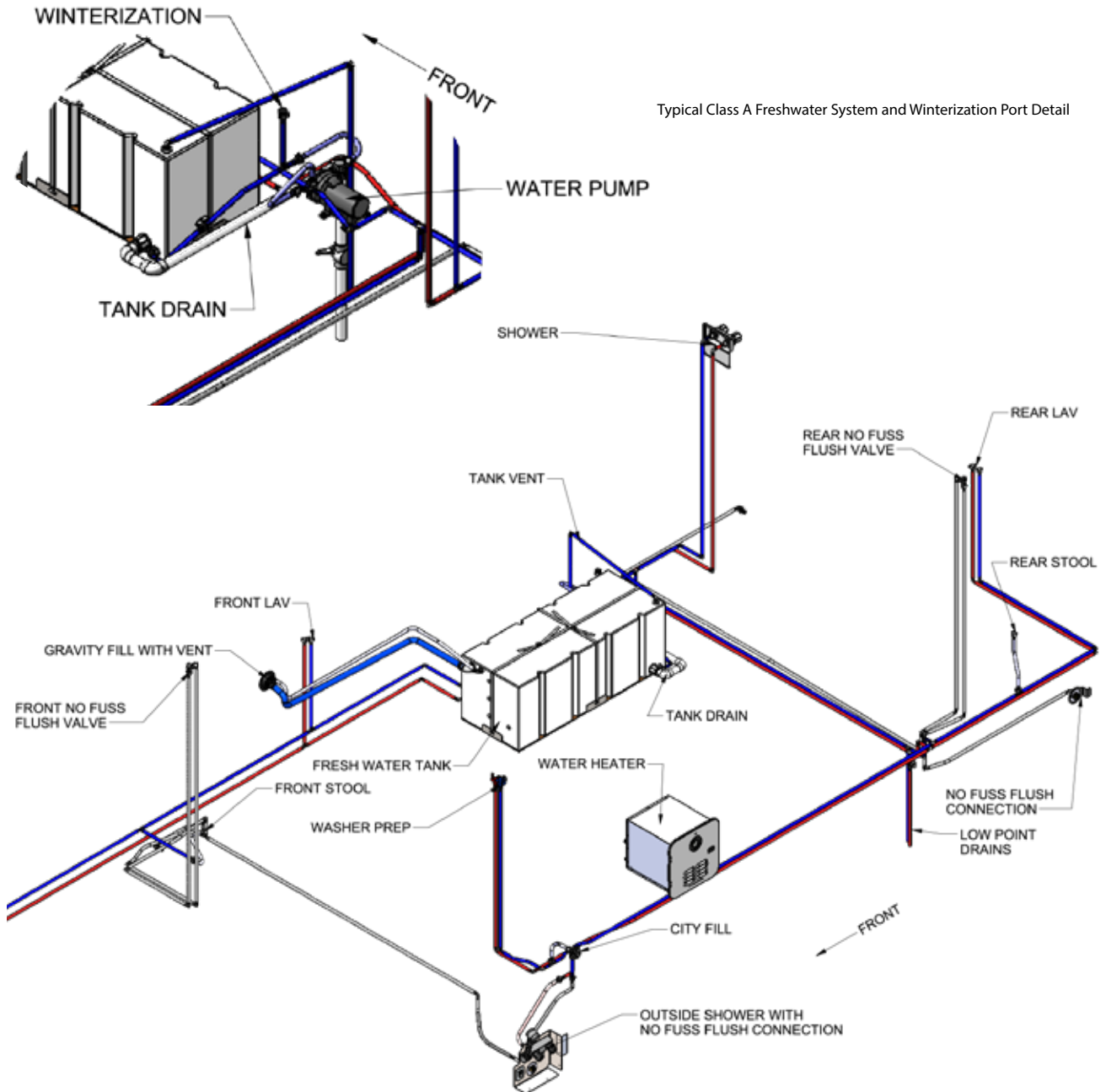

Typical Class A Freshwater System and Winterization Port Detail

## Wastewater System

The motorhome's wastewater system consists of bathroom fixtures, drainage plumbing, wastewater holding tanks, drainage vents, and sewage valves. It is important to become familiar with the motorhome's wastewater system, for it does require monitoring, routine, and long-term maintenance.

### Drainpipes

#### **NOTICE**

**Remove the waterless trap before using mechanical drain-rooting devices. Otherwise, the waterless trap can be damaged.**

Drainpipes have P-traps and/or waterless traps (HEPVOs) installed to help prevent drain odors from escaping into the motorhome. During travel, water within P-traps may displace, which could allow wastewater system odors into the motorhome. Drain-related odors come from decomposing materials in the holding tank. If odors are detected, place a few cups of water down each drain and use a RV approved deodorizing agent, which will reduce drain odors and help keep the drain lines and tanks clean and free flowing. Drain chemicals are available at RV supply stores.

### Vents

Vent pipes and vents release air from the gray and black water holding tanks. The exterior vent cap is attached to the roof and must be kept clear of debris and obstructions to perform as intended. On some brands and models, the vent pipe may be part of the drainage system referred to as a "wet vent" (water flows downward as air flows upward in the same pipe).

## Wastewater Holding Tanks

The motorhome is fitted with waste holding tanks designed to separately collect wastewater and waste solids. Typically, wastewater from kitchen sinks, bathroom sinks and bathroom shower(s) is collected and stored in the Gray Water tank, while solids from bathroom toilet(s) is collected and stored in the Black Water tank. Some floor plans have two black holding tanks, while others may drain bathroom sinks and/or the shower into the black tank. Wastewater collection tanks have valves that allow for emptying the tanks into an external sewage collection facility, commonly known as a 'dump station.'

When traveling, it is good practice to minimize the wastewater (gray and black) carried in the motorhome. This will reduce the on-board wastewater weight, potentially allowing carrying capacity for other cargo items. Refer to Section 6, Occupant and Cargo Carrying and Capacity (OCCC).

*NOTE: Monitoring the level of wastewater within the holding tanks is provided for on the Monitor Panel or, if equipped, on the main Multiplex touchscreen panel. Typically, tank level is indicated in 1/3 increments.*

### Toilet

#### **NOTICE**

**Some RV toilets have a black tank full signal, which prevents flushing water from entering the bowl until the black tank has been emptied. Check with the manufacturer or your dealer to determine whether the toilet installed has this feature.**

**Follow all manufacturer's instructions associated with the toilet, regardless of type, including preparation, use, waste disposal, cleaning, maintenance, cold weather use, winterizing, and storage.**

The toilet installed in the motorhome is designed to provide convenient and trouble-free operation when used properly. Unlike most residential toilets, RV toilets are tankless, meaning that the user fills the bowl just prior to use. Most toilets are operated by a foot-actuated pedal or lever, located either on the right side or the front of the toilet bowl and use gravity to directly discharge into the black water holding tank. The toilets bowls installed in TMC motorhomes may consist of ceramic or plastic materials.

Your motorhome's toilet may differ from the illustrations included in this manual. Always follow the manufacturer's operating instructions, available from your TMC Owners Resource account.

To use:

1. Turn ON the on-board water pump or connect the water system to an external pressurized source.
2. Add water to the toilet bowl by stepping partially down and holding the fill/flush pedal until the bowl is about 1/2 full.



Typical motorhome toilet installation

- To flush: press the fill/flush pedal completely down until the bowl empties.
- Monitor the black water holding tank levels and DO NOT use the toilet if the black water tank is full. Empty the black tank in an approved dump station before using the toilet.

It is a good practice to always check and flush (empty) the toilet bowl before departure. Water remaining in the toilet bowl could slosh onto the bathroom floor while traveling.

NOTES - Applies to all types of RV toilets:

- IMPORTANT** - Only use RV or Marine toilet paper with your motorhome's waste system. These paper products are specially formulated to break-down more readily than standard toilet paper products and help prevent waste system clogging.
- Do not flush hygiene, paper towels, plastics, or other non-biodegradable wastes into the wastewater system.
- Do not allow the black waste tank to become over-filled, resulting in an unsanitary spill-over.
- The toilet manufacturer may also recommend using cleaning products or chemicals that deodorize or aid waste decomposition.

Toilet Flushing Procedure:

- Depress lever 1/2 way to add freshwater to toilet bowl.
- After using toilet, depress lever to the floor, which rinses the bowl with freshwater and opens the waste valve, flushing waste into the black water holding tank.

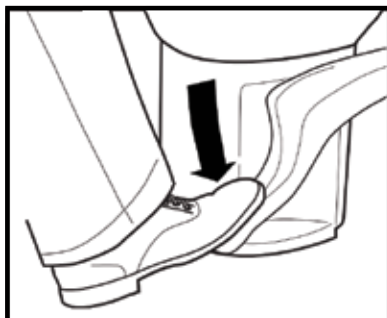
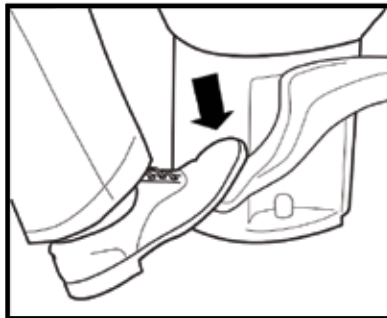

## Macerator Pump

### NOTICE

**The macerator pump operates automatically, turning on and off whenever a discharge from the toilet is sensed.**

**The macerator pump operates on 12-volts DC. The main battery switch must be ON for the macerator pump to operate as intended.**

TMC motorhome models may utilize a waste material macerator pump, either as part of the toilet, or as a separate pumping unit. The macerator is a device that grinds toilet waste material into fine particles, then pumps the waste to the black holding tank; making waste decomposition and disposal more efficient. Macerator pumps are typically used where the toilet installation is somewhat removed from the black water holding tank location. They are also used where a bathroom toilet is installed in a slideout, making toilet wastes easily pumped into the black water holding tank.

Typical 12-volt Macerator Pump



## Recirculation Mode

### NOTICE

**DO NOT operate the macerator pump in recirculating mode when the black tank is empty. Only operate the macerator pump in recirculating mode when the level of the black tank is at least 1/3 full. This will ensure the pump mechanism is not damaged by operating in a dry condition.**

In some installations, a macerator pump is also used as a recirculating pump for the waste tank. As it performs this function, it is reducing waste solids to very fine particles, thus reducing the chance of waste solids build-up on the tank surfaces and tank level sensors. If this function is available, there will be a macerator recirculating switch located on a bathroom wall switch panel, along with a switch located near the termination valves.

Please refer to your TMC Owner's Packet to determine if your motorhome is equipped with a macerator pump and if so, read and follow all special care and maintenance procedures.

## Macerating Toilets

Select TMC motorhomes are equipped with a macerating toilet. The use of this type of toilet is mainly due to the positioning of the black water holding tank to the toilet. Instead of the standard toilet's gravity discharge, the macerator toilet utilizes a motor that chops and grinds waste, then pumps the waste to the black tank. Being able to physically separate the toilet from the black water holding tank allows for greater floor plan design flexibility.



SFA Macerator Toilet and Luxe control panel.

## Operating the toilet

The toilet is supplied with a 3-position touch-activated control panel, which has the following features:

- **NORMAL:** Pressing the Normal position fills the toilet bowl with approximately 2.2 liters (0.6 gal) of water. The cycle time is approximately 19 seconds.
- **ECO:** When less water is needed, pressing the ECO position fills the toilet bowl with approximately 1.2 liters (0.3 gal) of water. The cycle time is approximately 10 seconds.
- **EMPTY:** Pressing EMPTY opens the bowl valve, turns ON the macerator pump and drains the bowl. The pump automatically turns OFF when it senses no more discharge is

coming from the toilet bowl. Once the bowl is empty, the bowl valve automatically closes.

- **TANK FULL Indication Light:** When the TANK FULL light is green, the black tank has room to accept more discharge. When the light is RED or flashing RED, the black tank is full and should be emptied before using the toilet.

*NOTE: If the RED light continues to flash after the black holding tank is emptied, PRESS and HOLD the NORMAL position switch for 5 seconds. This should re-set the tank level sensing device.*

*The entire process is easy to use and fully automatic.*

1. Before using the toilet, press either the ECO or NORMAL button. This places fresh water into the toilet bowl.
2. After using the toilet, simply press the EMPTY (flush) button to begin the operational cycle.
  - a. A flush mechanism is activated when you press the EMPTY button.
  - b. The macerator motor will start automatically, activating a fast-rotating blade that grinds and liquefies waste and toilet paper.
  - c. The waste is then pumped under pressure through waste plumbing pipes to the black water holding tank.

### Adjusting the Cycle Time

The rinsing time during the NORMAL cycle can be programmed, to add up to 5 seconds. Therefore, the cycle time can be increased from 19 seconds to 24 seconds, and water consumption will increase from 2.2 liters (0.6 gal) to 3 liters (0.8 gal).

*To enter the programming mode:*

1. Press the NORMAL and ECO buttons at the same time for at least 5 seconds.
2. The red LED flashes for 5 seconds and then goes out. To increase rinsing time by 1 second: press the NORMAL button. Each press will increase the cycle by an additional 1 second. A maximum of 5 presses (equaling 5 seconds) is possible. An audible beep will be heard at every press of the button.
3. To reduce rinsing cycle time by 1 second per press, tap the ECO button. An audible beep will be heard at each press of the button.
4. To exit the programming mode automatically, simply do not press any buttons for 5 seconds. After 5 seconds, the green light will illuminate, indicating the toilet is ready for normal operation. The new water consumption cycle remains in memory, even after the unit has been disconnected from the power supply.

## Care and Maintenance

### **NOTICE**

- **Only the disposal of toilet paper, fecal matter, and wastewater will be under warranty. Any damage due to foreign materials, such as cotton, condoms, sanitary towels, wet wipes, food, hair, or liquids such as oils, solvent products, will not be covered by the manufacturer's warranty.**
- **If the toilet will not be used for a long period of time, such as placing the motorhome in storage, or in the event of a long interruption of electricity, the water and electricity supplies to the SFA Toilet should be switched off.**

*To ensure your SFA macerator toilet operates smoothly, follow these important guidelines:*

- Only flush human waste and toilet paper. Do not flush other items, such as wet wipes, paper towels, tampons, or cotton balls, as these can jam the blades and damage the motor.
- Only use macerator-friendly toilet paper (RV toilet paper). This type of toilet paper breaks down more easily and prevents clogs.
- Regularly descale the unit. Descaling prevents the buildup of limescale and waste residue inside the pump. This can be done with a product designed specifically for macerator units.
- Turn off the power before inspection. If you hear a buzzing noise or suspect a jam, unplug the unit from its power source before attempting to remove any obstructions.
- Beware of constantly running motor. If the motor runs intermittently or continuously, check for a leaking tap or faulty water valve, as excess water can cause the pump to activate.
- Cleaning: Normal non-foaming household bleaches and toilet bowl cleansers can be used with this unit.

### Winterizing the Macerating Toilet

To winterize an SFA Luxe macerator toilet, you must ensure that non-toxic RV antifreeze cycles through the entire system, including the toilet bowl, macerator pump, and discharge lines. The most effective methods involve either gravity-feeding antifreeze into the bowl or using a siphon to pump it into the system.

#### Winterizing with the gravity-feed method

This simple method is the most common for RVs and other mobile applications.

1. Drain the water supply. First, turn off the water pump or shut off the main water supply valve to the macerator toilet.
2. Drain the system. Open any low-point drains to empty the fresh water lines.

3. Pour antifreeze into the bowl. Pour a sufficient amount of RV antifreeze directly into the toilet bowl.
4. Run the macerator. Press the flush or "drain" button to activate the macerator and pump the antifreeze into the holding tank. The pump will draw the antifreeze through the system.
5. Refill the bowl. Pour more antifreeze into the bowl to leave a small amount in the bottom, which keeps the seals and rubber components from drying out.

#### Winterizing with a siphon pump

This method is used to force antifreeze through the entire water supply system and may be necessary for some motorhome setups.

1. If connected to city water, disconnect from this external water source.
2. Pump out or drain the fresh water holding tank. If the toilet has a separate holding tank, ensure this tank is also completely drained.
3. Disconnect the water intake hose from the toilet's water valve or pump.
4. Place the detached hose into a container holding RV antifreeze.
5. Cycle the toilet. Flush the toilet to draw the antifreeze through the macerator pump and into the discharge lines and holding tank. Run the pump until only pink antifreeze is coming out. This operation may take one or two gallons of antifreeze.
6. Finish the process by add a small amount of antifreeze back into the bowl for lubrication. Reconnect the hoses once you are finished.

#### Important considerations

- Always follow your specific vehicle's or manual's instructions, especially concerning the location of valves and bypasses.
- Use non-toxic RV antifreeze only. Automotive antifreeze is highly toxic and can contaminate the system.
- If you are unsure of the location of valves or the specific process for your model, consult a professional plumber or RV technician.

## Termination Valves

The termination compartment generally contains the wastewater components listed in this section. Please note that due to the variety of TMC motorhome models and floor plans, the items described in this section are general in nature and may or may not pertain to your termination valve configuration.

- Termination valve handles for both gray and black water holding tanks. To open, grab handle, and pull outward. Make sure that the sewer drain hose is connected before opening these valves.
- Termination cap. Remove cap to install the flexible sewer drain hose (not supplied by TMC). Be sure that the termination valves are closed before removing this cap.
- Sewer holding tank flush attachment. Attach the city pressure hose and allow the water to flow for three minutes. Refer to the Black Tank Flush description in this section.
- Access cap for sewer pipe (typically for Class A motorhomes only). Located directly under sewer drain, remove cap and feed flexible sewer hose up through, and attach to the drain outlet.
- Exterior faucet. For mixing the water temperature for the exterior shower head.

*NOTE: It is typical to have one gray and one black termination valve for the gray and black tanks respectively. However, depending on the quantity and location of bathrooms, some floor plans have two black tanks with their own individual termination valves.*



Typical termination valve configuration

## Campsite Sewer Hook-up

### **NOTICE**

**For sanitary reasons, NEVER use a potable water hose for any wastewater dumping or sewer clean-up procedures.**

**When connected to a campsite sewer system, it is best to keep the termination valves CLOSED until the wastewater storage tanks need to be emptied.**

**Doing so provides two benefits:**

1. **Prevents campground sewer gases from entering the motorhome through the wastewater system.**
2. **Helps retain some fluidity in the black tank, which helps to keep solid wastes suspended, preventing solid waste buildup on the tank's interior surfaces.**

Many campgrounds offer wastewater discharge at the campsite or if not, an on-site dump station. If the campsite has a wastewater discharge, it is usually located on the driver's side of the site, along with the electrical and freshwater connections.

1. Park the motorhome close enough to the sewer inlet so that the sewer hose will reach from your motorhome's sewer discharge to the campsite's sewer inlet.
2. Ensure **BOTH** Black a Gray water termination valves are **CLOSED** (handles are fully IN).
3. Remove the cap on the motorhome's sewage discharge outlet.
4. Connect the sewer hose to the motorhome's wastewater discharge outlet, ensuring the clips on the sewer hose engage the tabs on the outlet.
5. Place the other end of the sewer hose into the campsite sewer inlet. Often, a heavy object, like a rock or piece of firewood is needed to help secure the hose into the sewer inlet.



Sewer hose connected to the motorhome's wastewater outlet.

*NOTE: There may be locations where the campsite's sewer inlet is too far away for your sewer hose to reach. In these situations, a sewer hose extension is needed. Sewer hose extensions are available from RV retailers.*

## Emptying Wastewater Holding Tanks

Whether emptying wastewater tanks at a campsite sewer inlet or at a campground dump station, follow this procedure:

1. Before emptying the wastewater holding tanks, check the level of the black tank. It should be at least 3/4 full. This will help insure the tank empties efficiently. If necessary, add water to the tank by flushing the toilet a few times.
  2. Remove the cap from the sewer drain and connect the flexible sewer drain hose, ensuring the clips on the hose connector engage the tabs on the sewer discharge outlet.
  3. Place the other end of the flexible sewer drain hose into the dump station inlet. Be sure both ends of the flexible sewer drain hose are secured.
  4. Drain the black water holding tank **FIRST** by pulling the **BLACK** termination valve handle away from the valve body. Be sure to allow sufficient time for the wastes to k to completely drain from the tank, then rinse the black water holding tank with several gallons of water by depressing the toilet flush pedal (flush handle) or better yet, use the black tank flush (if equipped).
- NOTE:** See following section for Black Tank Flush procedure.
5. Drain the gray water holding tank by pulling the **GRAY** termination valve handle away from the valve body. Draining the gray water holding tank after the black tank allows gray water to rinse solid waste from the flexible sewer drain hose.



Black tank termination valve in the OPEN position.

6. When both the black water and gray water tanks are emptied, close the termination valves; **GRAY VALVE FIRST, THEN THE BLACK VALVE**, by pushing the handles back to the closed positions.

**NOTE: DO NOT** close the Black termination valve until black tank flushing procedure is complete and water source is turned OFF.



Closing the termination valves; close the gray valve first, then black valve.

7. Remove the flexible sewer drain hose from the sewer drain outlet and while the other end of the sewer hose is still in the dump station inlet, rinse it thoroughly with clean water from a garden hose, or if available, the motorhome's exterior shower or spray port. Most dump stations provide a water hose spigot.
8. Lift the free end of the sewer hose, allowing it to drain completely into the dump station inlet. Then, remove the sewer hose from the dump station inlet and stow it in its storage container.
9. Replace the sewer caps onto the motorhome's sewage outlet and replace the cap or cover on the dump station inlet.
10. Spray off any sewage spills before disconnecting and stowing the garden hose.
11. Flush the toilet a few times to add a small amount of water to the black tank. This will help keep any remaining solid wastes from drying or adhering to the tank surfaces.

*NOTE: Always wear rubber or vinyl gloves and protective eye wear when emptying the holding tanks and NEVER use a potable water hose for wastewater dumping or clean-up procedures.*

## Black Holding Tank Flush

### **⚠ CAUTION**

**DO NOT USE THE BLACK TANK FLUSH SYSTEM UNLESS THE BLACK TANK TERMINATION VALVE IS IN THE OPEN POSITION.**

**The black tank could overflow into the motorhome if the termination valve is not open, which will result in an unsanitary condition, possibly leading to illness or potential personal injury.**

After black tank dumping, some solids may be left at the bottom of the black water tank as well as on the tank sidewalls. The black tank rinse is designed to help flush the black tank of waste solids. To use:

1. Ensure the sewer hose is connected to the motorhome's sewer outlet and the dump station inlet.
2. Connect a garden hose (reserved for this task) to the dump station water supply and the black tank rinse port.

*For sanitary reasons,*

**DO NOT USE YOUR POTABLE FRESHWATER HOSE FOR THE BLACK TANK RINSE OR OTHER WASTEWATER CLEAN-UP PROCEDURES.**

**DO NOT turn the rinse water ON until the black tank has emptied.**

3. Ensure the black tank termination T-valve is **OPEN**.
4. Turn ON the rinse water and let the water run for several minutes. During the rinsing/flushing process, be sure the termination valve remains open, and the flexible sewer drain hose remains connected between the motorhome's sewage drain outlet and the dump station inlet.
5. When rinsing/flushing is complete, turn off the water supply. Disconnect the water hose from the black tank rinse port.
6. Close the black tank termination valve.
7. Disconnect the sewer hose from the motorhome. While the other end of the sewer hose is connected to the dump station inlet, rinse the sewer hose, inside and out, with water from the dump station's water supply. Let the rinse water drain into the dump station inlet.
8. When complete, stow the sewer hose and rinse hose.



Typical black tank flush port located on the left side of the motorhome.

### Without Black Tank Flush:

If the motorhome does not have a black tank rinse system, you can use water from the toilet bowl to rinse the black holding tank:

1. Ask your partner to flush the toilet several times, placing clean rinse water into the black tank. Do this immediately after dumping the black tank and while the flexible sewer hose is still connected to the sewer outlet of the motorhome and to the dump station inlet. The black termination valve must remain OPEN.
2. This rinsing process may need to be done several times. When finished, close the black termination valve, clean and stow the sewer hose.

*This page is intentionally blank*

## Introduction

Your motorhome's heating and cooling system consists of equipment sourced from a variety of manufacturers, yet the individual components are designed to function as an integrated system. Components may have manufacturer's warranties and registrations. Your dealer can assist you with completing component registrations.

Due to the wide variety of Thor Motor Coach models and floor plans, heating and cooling information that is uniquely specific to your particular motorhome is not included in this manual. Please review and retain all manufacturer's instruction manuals and documentation that is included with your TMC Owner's Packet. The manufacturers of the heating and cooling equipment installed in your motorhome are the best source for information regarding component features, operation, and maintenance.

Always refer to the manufacturer's documentation if you have questions regarding your heating and cooling system that are not covered in this manual. TMC Customer Care representatives are also available to answer any question you may have. Call toll free: 877-855-2867

The heating, ventilation, and air-conditioning (HVAC) functions of your motorhome consist of two separate systems: the dash (vehicle) and house (living space). Much like the heating and air-conditioning systems in passenger cars, the dash system is designed to heat and cool the front driver and passenger compartment, along with providing windshield defrosting. Although the dash heating and air-conditioning system of your motorhome is generally more powerful than standard automobile systems, it is not designed to heat and cool the entire motorhome, even while the vehicle is in motion.

If cooling of the living space is needed while the vehicle is in motion, it is possible to operate the house air conditioner(s), however, to do so, the on-board generator must be in operation, supplying 120-volts AC to the air-conditioning units. The master battery switch must also be ON, providing power to HVAC control devices.



Regardless of the outside temperature, your motorhome's heating and cooling system will keep you and your traveling companions comfortable.



**IMPORTANT! DO NOT OPERATE THE PROPANE GAS FURNACE, OR ANY OTHER PROPANE APPLIANCE, WHILE THE VEHICLE IS IN MOTION.**

## Dash Heater and Air Conditioner



### CAUTION

**The vehicle air-conditioning system contains refrigerant 134a under high pressure and should only be serviced by qualified technicians. Improper service methods could cause severe personal injury.**

## Control Panel

The heater and air conditioner dash controls for most TMC Class C motorhomes is similar to what is found in many passenger and light commercial vehicles and is installed by the chassis manufacturer. For Class C dash control operation, refer to the chassis manufacturer's instructions provided in your Owner's Packet.

Class A dash heating and air-conditioning units differ in that they are installed by the motorhome manufacturer. Both operate similarly in controls and functions, and both require the vehicle's engine to be running in order to heat or cool the cockpit of the motorhome.

The typical control panel consists of three rotary dials, which regulate FAN SPEED, TEMPERATURE, and VENTING. The configuration of these controls may differ from model-to-model, but the functions are similar. Motorhomes may be equipped with touch-panel dash temperature controls.



Typical Class A heating and air-conditioning dash controls

The heater/air conditioner unit is located beneath the dash or on the firewall. In most modes of operation, the unit takes fresh air from outside of the vehicle and heats or cools it before discharging into the cockpit area. Only when operated in the MAX A/C mode does the system recirculate air from inside the cockpit area, thus maximizing the cooling effect of the air conditioner.

#### Operating features:

The air-conditioning system is designed to operate in all modes except VENT, FLOOR and OFF. Operating the air conditioner provides significant moisture, dust, and pollen removal for enhanced passenger comfort. Use MAX A/C and HI Fan for quick cool down. To assist with cooling, close all windows and vents to hot, humid outside air.

To achieve the maximum comfort in the motorhome, the air must be directed where it is needed. Some dash units may feature a mode switch, which gives the driver the ability to select where the air will flow, floor, dash vents, or a blend.

#### General maintenance:

Keep the condenser and radiator free of bugs and debris. During periods of little use, operate the A/C system monthly to keep the compressor lubricated. Periodically inspect belts and hoses for wear and proper tension.

#### Warranty/Service:

If repairs are necessary during the terms of the motorhome warranty, please contact the nearest authorized Thor Motor Coach dealer for service. In the event repairs are necessary during your travels, contact Thor Motor Coach Customer Care. Certain individual parts of the Heating and Air-conditioning System such as the compressor, dryer and condenser are covered under the chassis manufacturer's warranty.

*NOTE: Components covered under the TMC Limited Warranty must be Original Equipment Manufacturer (OEM) parts. The installation of aftermarket components or unauthorized repairs may void the warranty.*

## Heating/Cooling with Multiplex Integration

Your motorhome may be equipped with a programmable multiplex system that, among other features, will include integrated control of the motorhome's interior climate (both heating and cooling), and all HVAC-related devices. Your multiplex system panel may look different than the illustrations below, but will function similarly.

#### To operate:

1. Turn ON the master battery switch, providing 12-volt DC power to the HVAC control unit(s).
  - a. If heat is desired, ensure the main propane valve is ON prior to selecting HEAT.
  - b. If cooling is desired, ensure 120-volts AC is available for the air conditioner(s).
2. Select the Temperature-setting feature by either touching the temperature icon along the edge of the multiplex panel or touching the temperature icon on the panel screen.
3. Select the zone you wish to control. Depending on motorhome configuration, there may be one, two, or three temperature zones.
4. Select cooling or heating by pressing the appropriate area on the screen.
5. Select the desired temperature setting by either touching the UP or DOWN arrows.
 

If desired, select the fan speed by touching the HIGH, LOW, or AUTO areas on the screen.
6. For total automation, select AUTO, which will turn on the air conditioner(s) or if needed, the furnace depending on selected temperature setting.
7. Return to the MAIN MENU by touching the 'House-shaped' icon on the panel or touching return arrows on the screen.



Typical multiplex control panels depicting climate control display

## Wall-mounted Thermostats

Unless equipped with a multiplex control system, your TMC motorhome will have a wall-mounted thermostat for convenient control of the heating and air-conditioning functions. Although different in appearance, RV thermostats offer these basic functions:

- Selecting between Heat, Cool, or Fan Only;
- Selecting a fan speed range;
- Selecting the temperature set point.

The thermostat remotely operates both the furnace and the air conditioner(s) of your motorhome and depending on thermostat model, may offer other control features. Wall mounted thermostats may be analog or feature a digital display. Both models operate similarly. If your air-conditioning units are equipped with the optional Elect-A-Heat function, this selection will be indicated as electric heat on the front of the thermostat.

To operate:

1. Turn ON the master battery switch, providing 12-volt DC power to the HVAC control unit(s).
  - a. If heat is desired, ensure the main propane valve is ON prior to selecting HEAT.
  - b. If cooling is desired, ensure 120-volts AC is available for the air conditioner(s).
2. On the thermostat, select Heat, Cool, or Auto.
3. Set the desired temperature. Depending upon the selection, the furnace or air conditioner(s) will begin operation.

If a wall-mounted thermostat or multiplex system is not installed in the motorhome, then air conditioner functions are controlled from a panel on the unit itself (ceiling panel).



Typical RV thermostats illustrating Analog and Digital temperature setting. Note: The thermostat installed in your motorhome may differ from these illustrations.



*NOTE: For complete information regarding the particular HVAC control device installed on your motorhome, refer to the information contained with your TMC Owner's Packet, supplied with your motorhome.*

Coleman-Mach Digital Thermostat.



Dometic Fan Tastic® Ventilation Fan

## Ceiling and Ventilation Fans

Your vehicle may be equipped with high-volume ceiling and ventilation fan(s). If equipped, the fan(s) can be operated as a powered vent; to draw in cool outside air, or as a ceiling fan to circulate the inside air of the motorhome. Fans are usually equipped with a translucent rain cover, which can be opened, partially opened, or closed.

Refer to the TMC HVAC System Guide for complete operational and maintenance instructions pertaining to motorhome ventilation and fan operation. Also, refer to the Care and Maintenance Section of this manual for important condensation information.

## Cooling the Motorhome

TMC motorhomes are equipped with one or more roof-mounted air conditioners. Select motorhomes are equipped with roof-mounted heat pumps (air conditioners with built-in heating features), while other motorhomes may feature a combination of roof-mounted and wall-mounted air-conditioning units. The compressors and fans of all roof-mounted air conditioners operate on 120-volts AC, supplied by shore power or from the on-board generator, while the control circuits usually operate on 12-volts DC. Due to the electrical load of an air conditioner, they are not powered by the standard inverter that is supplied with an on-board electrical generator system.

All air conditioners are rated in British Thermal Units (BTU), which is a measure of their cooling capacity. The higher this number, the higher the unit's cooling ability. Ensure that the shore power source is adequate for the power needed to operate the air conditioner(s).

### Temperature Differential

The ability of the air conditioner to maintain the desired inside temperature depends on the heat gain of the motorhome. The size of the vehicle, amount of window area, amount of insulation, amount of direct exposure to the sun, outside temperature, and the number of people occupying the inside space are factors that may increase the heat gain to such an extent that the ability of the air conditioner to cool the motorhome to the desired temperature is compromised. Under most operating conditions, can expect a 15-to-20 degree temperature differential between the outside air and the discharge air of the air conditioner.

As long as this temperature differential is being maintained, the air conditioner is operating at its capacity. If the desired inside temperature (normally 75°-80° F) cannot be maintained, then the heat gain within the motorhome is too great for the capacity of the air conditioner.



Typical Roof-mount  
Air Conditioner

To increase the effectiveness of the house air conditioner, try reducing the heat gain of the motorhome by:

- Park the motorhome in a shaded location.
- Use window and patio awnings when outside ambient temperature is above 95° F to help deflect the heating effects of the sun. If window awnings are not installed or cannot be used, cover windows with shades or blinds.
- Try to avoid using the cook top or oven when the ambient temperature is over 95° F.
- When parked, keep windshield covered when facing the afternoon sun.
- Minimize opening exterior doors when the air conditioner is running.

### NOTES:

- 120-volts AC must be present in order to operate air conditioners and/or heat pumps. The energy can be supplied by shore power or the on-board generator.
- Air conditioners are designed to cool approximately 20° F (11° C) lower than the outside ambient air. On extremely hot days, the air conditioner may not be able to cool the motorhome to the desired temperature.
- During warm weather, it is best to start the air conditioner early in the day, allowing it to cool-down and keep the interior of the motorhome at a comfortable temperature before the outside temperature creates too much of a temperature differential for the air conditioner to operate effectively.

## Manual Controls for Roof-Mount Air Conditioners

### **NOTICE**

**NEVER operate air conditioners and heat pump without filters. Doing so will clog the evaporator coil and may substantially degrade the performance of the unit.**

Three basic controls on the air conditioner's ceiling assembly operate the air conditioner's functions. The three controls are:

#### Selector switch:

The selector switch determines which mode of operation the air conditioner will be in. By rotating the selector switch, the operator can obtain any system function desired. System functions vary depending upon options of the air-conditioning unit.

#### Thermostat (temperature control):

In the cooling mode, the thermostat regulates the ON and OFF temperature setting at which the compressor will operate. For 'Heat/Cool' models (heat pumps and units with built-in heating coils), the thermostat also controls the ON and OFF temperature setting of the heater assembly.

#### Louvers:

The louvers are located at both ends of the ceiling assembly shroud and are used in directing the discharge air from the air-conditioning unit.

*NOTE: Some air conditioners are supplied with an optional Elect-A-Heat heating device, which is intended to take the chill out of the indoor air when the air is a few degrees too cool for comfort. This heating element is an effective 'chill chaser,' but is not a substitute for a furnace.*

## Basic Air Conditioner Operation

The following basic instructions pertain to all air conditioner installations, regardless of the control device (multiplex panel, wall-mounted thermostat, or on-unit control panel).

1. Turn ON the master battery switch. This will provide 12-volts DC to the control system of the air conditioner.
2. Turn ON the generator OR connect the motorhome to a shore power source (refer to Electrical System, Section 10). This will provide 120-volts AC to the air conditioner's compressor and fan.

#### Cooling:

1. Turn the selector switch (if applicable) to the LOW COOL or HIGH COOL positions.
2. Rotate, slide, or move the thermostat (temperature control) to the desired interior temperature setting. The thermostat will turn the compressor on when the temperature of the air entering the air conditioner rises a few degrees above the selected temperature setting. The thermostat will continue to cycle the compressor on and off in the above-mentioned fashion until the selector switch is turned to another mode of operation.
3. Position the louvers to the desired direction of air flow.

#### Operation during cooler nights:

When the outdoor temperature drops in the evening or during the night to below 75 degrees F (24° C), it is important that the thermostat (temperature control) be set at a midpoint between WARMER and COOLER. If the setting is at COOLER, the evaporator coil may become iced-up and stop cooling. During the day when the temperatures have risen above 75 degrees F (24° C), reset the thermostat switch to the desired setting.

*NOTE: Should icing-up occur, it is necessary to let the cooling (evaporator) coil defrost before normal cooling operation is resumed. During this time, operate the unit in the 'High Fan' position with the system at maximum air flow. When increased or full air flow is observed, the cooling coil should be clear of ice.*

#### Air circulation only:

- Turn the selector switch to LOW FAN or for maximum air flow, HIGH FAN.
- Position the louvers to the desired direction of air flow.

#### Short cycling:

- When an air conditioner is in operation, its compressor circulates refrigerant under high pressure. Once off, it will take two to three minutes for this high pressure to equalize.
- The air-conditioning compressor is unable to start against high pressure. Therefore, once the air conditioner is turned off, it is important to keep it off for two to three minutes before restarting.
- Short cycling the compressor (or starting it before pressures have equalized), will in some instances, trip the circuit breaker.

## Heat Pumps

Select TMC motorhomes are equipped with roof-mounted heat pumps. Heat pumps provide both cooling and supplemental cabin heating. When the cabin temperature rises to where air-conditioning is needed, the heat pump provides cool, comfortable air. If the cabin temperature drops to where heat is required, the heat pump provides heated air to maintain cabin comfort. The controller will automatically turn on the LP gas furnace (or hydronic heating system, if installed) when the outside air temperature reaches a level where the heat pump can no longer efficiently heat the cabin.

The advantage of a heat pump system is that when connected to shore power, the heating needs of the cabin are supplemented by the heat pump, therefore, reducing the heating demands of the furnace, which conserves LP usage (or diesel fuel, with a hydronic heating system).

Roof-mounted heat pumps have a low-profile design, for reduced wind resistance while underway. 120-volts AC shore power or on-board generated power must be available in order to operate the heat pump.

Heat pump operation:

The operation and maintenance of the heat pump is similar to the roof-mounted air conditioner mentioned in the previous section. Refer to the HVAC Control Section for heat pump operation.

Motorhomes with multiplex control systems, climate control may be integrated with the multiplex control panel(s).

*NOTE: For complete information regarding the operation and maintenance of your motorhome's air conditioner(s) and/or heat pump(s), please refer to the manufacturer's instruction manual, supplied with your TMC Owner's Packet, your on-line TMC Owners Resource Information Service:*

[thormotorcoach.com/owners/](http://thormotorcoach.com/owners/)

or, visit the appliance manufacturer's website.



Roof-mounted low-profile heat pump. Exterior cover may be white or black.

## Heating the Motorhome

### Propane Furnaces

#### **⚠ DANGER**

**BE SURE THE FURNACE AND ALL IGNITION SYSTEMS ARE 'OFF' DURING ANY REFUELING AND WHILE VEHICLE IS IN MOTION OR BEING TOWED.**

**DO NOT STORE OR USE GASOLINE OR OTHER FLAMMABLE VAPORS AND LIQUIDS IN THE VICINITY OF THIS APPLIANCE.**

#### **⚠ DANGER**

##### **IF YOU SMELL PROPANE GAS**

1. Extinguish any open flames and all smoking materials.
2. Shut off the propane supply at the container valve(s) or propane supply connection.
3. **DO NOT** touch or operate electrical switches.
4. Open doors and other ventilating openings.
5. Leave the area until the odor clears.
6. Have the propane system checked and leakage source corrected before using again.

Ignition of flammable vapors could lead to a fire or explosion and result in death or severe injury.

#### **⚠ WARNING**

##### **CARBON MONOXIDE POISONING WARNING:**

- Doors must be properly sealed and draft cap and assemblies must be adjusted and sealed correctly to prevent carbon monoxide from entering coach.
- Combustion air must **NOT** be drawn from within any living area.
- **DO NOT** vent exhaust into living area or outside into an enclosed porch area.
- **DO NOT** vent any other appliance with venting systems serving the furnace.
- **DO NOT** allow snow or any objects to block exhaust system of furnace.
- **DO NOT** use the furnace cabinet area as a storage compartment.
- **DO NOT** block furnace outlet registers or return air grills.
- Keep all insulating materials away from furnace.
- Installation, repairs, and preventive maintenance should be done by a qualified service technician only.
- Failure to follow safety warnings exactly could result in dangerous operation, severe injury, death, or property damage.

## **⚠ CAUTION**

**THIS APPLIANCE IS EQUIPPED WITH AN ELECTRONIC IGNITION DEVICE THAT AUTOMATICALLY LIGHTS THE BURNER. DO NOT TRY TO LIGHT THE BURNER BY HAND.**

**DO NOT touch exhaust grills when furnace is operating.**

**Heat registers can reach high temperatures when the furnace is running and can cause a burn if skin is in contact with the register.**

Most TMC motorhome models are equipped with a propane-fired, forced-air furnace, appropriately sized for the living space of the motorhome. Also, depending on the size of the living space, the heating system may have multiple registers that facilitate even heating throughout. With a forced-air system, there will be one, centrally located thermostat used to control the air temperature of the motorhome.

Detailed information regarding the heating and cooling equipment that is uniquely specific to your motorhome is not covered in this manual. Please review and retain all manufacturer's owner's manuals and documentation that is included with your TMC Owner's Packet. The manufacturers of the heating and cooling equipment installed in your motorhome are the best source for information regarding component features, operation, and maintenance.

For safe heating system operation, please follow all safety warnings pertaining to the furnace, hydronic system (if installed), propane system and electrical system printed in all manufacturer's documentation and labels attached to your motorhome. It is also recommended that you read the Propane Systems Guide and become familiar with the entire propane system of your motorhome. If you have questions regarding your heating and cooling system, TMC Customer Care representatives are also available to answer any question you may have. Call toll free at: 877-855-2867

## Furnace Operation

The furnace supplied with your motorhome is equipped with an electronic ignition. **NEVER** attempt to light the burner by hand.

Before operating the furnace, smell all around the appliance area for gas. If gas is detected, either by smell or by the CO/LP alarm, **DO NOT** attempt to operate the furnace.



Typical forced-air furnace installation

For your safety, gas leaks **MUST** be repaired before operating any gas or electrical appliance.

### Turning the furnace ON:

1. Ensure the motorhome's 12-volts DC electrical system is ON by turning on the master battery switch, connecting to shore power or operating the generator.
2. Turn ON LP gas supply at the propane tank. Counterclockwise rotation opens the valve; clockwise rotation closes the valve.
3. Check that power to the furnace is ON at the main power distribution panel.
4. Set the thermostat selector switch to HEAT.
5. Set the desired temperature on the thermostat. The furnace should automatically come on if the temperature setting on the thermostat is higher than the ambient air temperature.

### Turning the furnace OFF:

1. Reduce the temperature setting on the thermostat to its minimum level.
2. Set the selector switch on the thermostat to OFF.
3. If you are preparing to travel, turn OFF the LP gas supply at the tank.

### NOTES:

- During the initial operation of the furnace, you may detect slight fumes caused from the burning of residue and oils left from the manufacturing process. This is a normal occurrence, and these fumes should subside within several minutes.
- If the outside temperature will drop below 32° F (0° C) AND your motorhome is remaining parked, AND is not winterized, allow the furnace to operate in order to prevent the possibility of on-board water freezing and causing damage to the motorhome's water system.
- For additional information regarding heating and cooling systems installed on your motorhome, please refer to the TMC HVAC System Guide and the furnace manufacturer's product information available through the TMC on-line Owners Resource Information Service: [thormotorcoach.com/owners/](http://thormotorcoach.com/owners/)

## Furnace Care and Maintenance

### **DANGER**

The combustion of any hydrocarbon-based fuel creates carbon monoxide (CO) gas, which is extremely poisonous to humans and pets. Carbon monoxide gas is tasteless and odorless!

- **Inspect furnace burners annually for proper combustion. Inspect for holes or cracks in combustion chambers, that if exist, could allow carbon monoxide gas into living space of the motorhome.**
- **Inspect propane (LP) system annually for cracks, leaks and worn components.**
- **Repair or replace faulty furnace and/or propane (LP) system components promptly.**
- **DO NOT block or restrict furnace air intakes and/or exhausts.**
- **Test the CO/LP detector regularly to ensure proper operation.**
- **Know and practice evacuation procedures if LP and/or CO gas is detected.**

### **WARNING**

- **DO NOT use this appliance if any part has been under water. A flood-damaged furnace is extremely dangerous. Attempts to use the furnace can result in fire or explosion.**
- **A qualified service technician should be contacted to inspect the furnace and to replace all gas controls, control system parts, electrical parts that have been wet or replace the entire furnace, if deemed necessary.**
- **ROAD VIBRATION CAN LOOSEN PROPANE FITTINGS. It is important to check the Propane System for leaks at least every 5,000 miles, and whenever the tank is filled. It is also recommended to have the entire Propane System checked annually by a qualified propane service technician.**
- **DO NOT install screens over the intake air or exhaust vents for any reason. Screens will become restricted and cause unsafe furnace operation.**
- **For your safety, only factory authorized parts are to be used on your furnace and venting system.**

Listed here are several safety related instructions that you, the owner, should follow each heating season to assure continued safe operation of the furnace. A periodic inspection of the furnace by a qualified service technician is also recommended.

- At the beginning of the travel season, before each trip, and periodically during the travel season, test the combination CO/LP detector for proper function. Immediately repair or replace malfunctioning CO/LP detectors.

- Inspect furnace venting. Venting must be free of obstructions, absent of soot, and properly terminated to the exterior of the motorhome. Make sure that the vent assembly is positioned tight against outer door.
- Periodically inspect the exhaust vent for soot. Soot is formed whenever combustion is incomplete. This is a visual warning that the furnace is operating in an unsafe manner. If soot is present, immediately shut furnace down and arrange for repairs by a qualified service center or technician.
- Keep furnace clean. More frequent cleaning may be required due to excessive lint from carpeting, bedding material, pet hair, etc. It is imperative that the control compartment, burners, and circulating air passageways of the appliance be kept clean and unobstructed.
- The furnace motor is permanently lubricated and requires no oiling.
- Keep the furnace area clear of any combustible materials, flammable liquids, or vapors.
- Before operating furnace, check the location of the furnace vent to make sure it will not be blocked by the opening of any door or obstacle. **DO NOT** operate the furnace if the vent is blocked or obstructed in any way.
- **DO NOT** restrict the flow of combustion air or the warm air circulation of the furnace. To do so could cause furnace malfunction, leading to personal injury and/or death.
- **NEVER** operate the furnace if the smell of propane gas is detected. **DO NOT** assume that the smell of gas in the motorhome is normal. Any time the odor of propane gas is detected, consider it life threatening and correct the problem immediately. Extinguish all open flames; evacuate the motorhome; shut off the LP gas supply at the tank.
- Immediately shut furnace down and call a service technician for repairs if the furnace cycles erratically or delays on ignition.
- **NEVER** allow an unqualified person to attempt furnace repairs.
- **NEVER** restrict the ducting installed by the RV manufacturer. To do so could cause improper furnace operation.
- **DO NOT** install air boosters (fans) in the duct system. Such devices will cause the furnace to cycle on limit and to have erratic operation.
- **DO NOT** place clothing or other flammable materials on or near the furnace.
- **ALWAYS** follow operating instructions. **DO NOT** deviate from step-by-step instructions.
- **DO NOT** use petroleum or citrus type cleaner on plastic parts, as damage may occur.

## Hydronic Heating: Aqua-Hot 250 and 125 Series Systems

### DANGER

- All heating sources (diesel, propane, gasoline, and electric) must be switched OFF when refueling the motorhome.
- DO NOT operate the hydronic heating system if the motorhome is parked inside an enclosed building. Fumes from burning fuel create dangerous Carbon Monoxide gas, which is lethal to humans and pets.

If the manufacturer's instructions are not followed exactly, a fire or explosion may result, causing property damage, personal injury, or death.

### WARNING

- Read and follow all safety warnings affixed to the hydronic heating unit and published in the manufacturer's operational and maintenance manuals.
- The product identity label contains specifications of the unit, to what standard it has been tested, and important safety notices.
- ONLY use Propylene Glycol based antifreeze - Generally Recognized As Safe - (GRAS) by the FDA, for the antifreeze and water heating solution.
- For safety purposes, an interlock switch prevents the Aqua-Hot heater from operating when the cover is not installed in the correct position.
- Do not store or use gasoline or other flammable vapors or liquids in the vicinity of this or any other appliance.
- Disconnect electric wiring to the Aqua-Hot System before welding or plasma cutting the RV to avoid damage to equipment.
- The Aqua-Hot tank and heating loop operate at 0.0 PSI (zero pressure system). Air pressure to the tank must not exceed 20 PSI. Exceeding this rating will cause internal damage to the Aqua-Hot.
- DO NOT connect the 12-volt DC power to the Aqua-Hot if the vehicle requires welding.
- At maximum operating temperature, the coolant will be very hot and scalding hot vapor or coolant may result in serious burns or injury. Be aware of hot surfaces.
- Do NOT activate the burner until the antifreeze and water heating solution has been added to the boiler tank to avoid serious damage to the heater.
- Should any additional assistance be needed, please contact the Aqua-Hot Product Application Department at 574-AIRXCEL (574-247-9235).

### WARNING

Observe all warning and caution labels printed in the manufacturer's owner's manual and affixed to the Aqua-Hot hydronic heating system. Failure to follow proper operation and maintenance procedures could lead to serious personal injury and severe property damage.

### CAUTION

THE HYDRONIC SYSTEM'S EXHAUST IS HOT!

DO NOT park in areas where dry conditions exist (i.e. dry, grass, leaves, or other vegetation).

If maintenance to the hydronic unit is required always allow the system to completely shut-down and cool before disconnecting electrical or fuel connections.

### CAUTION

DO NOT activate the burner until the antifreeze and water heating solution has been added to the boiler tank to avoid serious damage to the heater.

### NOTICE

- This appliance operates on both AC and DC power.
- Use only nontoxic propylene glycol-based boiler antifreeze with additives generally recognized as safe (GRAS) by the FDA.
- Failure to winterize your heater, when stored in freezing temperatures, will result in serious damage to the product's domestic hot water heating system.
- Air pressure applied to the tank must not exceed 20 psi. Excess pressure will result in internal damage.
- It is imperative that you read and follow all the operation and maintenance instructions printed by the manufacturer for your Aqua-Hot Hydronic System.
- This appliance does not have a pilot. It is equipped with an ignition device, which automatically lights the burner. Do not try to light the burner by hand.
- BEFORE OPERATING: smell all around the appliance area for gas or other fuel vapors. Be sure to smell next to the floor because some gas is heavier than air and will settle on the floor.
- IF YOU SMELL GAS, OR OTHER FUEL VAPORS: follow the instructions listed in the Safety 'DANGER' Warning Labels installed in your motorhome.
- Use only your hand to push in or turn the gas control knob. Never use tools. If the knob will not push or turn by hand, don't try to repair it; call a qualified service technician. Forced or attempted repairs may result in a fire or explosion.

## NOTICE

- **Do not use this appliance if any part has been under water. Immediately call a qualified service technician to inspect the appliance and to replace any part of the control system and any gas control which has been under water.**
- **The Aqua-Hot closed-loop heating system uses a solution with anti-freeze properties that IS NOT the same as the RV antifreeze used to winterize the water system of your motorhome.**
- **Only use Aqua-Hot approved solution in the fluid reservoir of the Aqua-Hot system and ONLY USE RV antifreeze for winterizing the water system of the motorhome.**
- **For detailed information, reference the owner's manual or contact Aqua-Hot Heating Systems, Inc. at 1-800-685-4298.**

The Hydronic Heating System performs three functions:

- **Interior Heating System:** provides quiet, comfortable interior heat with independent temperature zones, controlled by separate heat exchangers, that provide cabin-wide even temperature control.
- **Tankless Hot Water System:** provides a steady flow of continuous hot water.
- **Bay Heating System (Class A only):** keeps pipes and tanks from freezing in the bay storage area.

Select Class A and Class C motorhomes are equipped with a **hydronic heating system**. This system uses a diesel-fueled, or with some models, a propane or gasoline burner to heat a volume of heat exchange fluid (mixture of antifreeze and distilled water, which contains special corrosion prevention properties), that is circulated to zoned heat exchangers located throughout the motorhome. The hot fluid enters the heat exchangers, where the



Aqua-Hot Series 250 Hydronic system main unit.

fluid passes through a series of coiled tubing. As the temperature of the coils rise, a fan blows ambient air across the coils, heating the air, which is directed to the living space of the motorhome. Heating zones are separately controlled by individual thermostats (if installed), so that the air temperature of specific areas of the motorhome can be individually controlled.

When hot water is requested by the opening of a hot water faucet, pressurized cold water from the RV's freshwater tank or city water source is transported through a cold-water line that goes into a heat exchanger located within the Aqua-Hot unit. Heated by contact with the heated antifreeze and distilled water solution, the hot water then flows through a tempering valve, where it is mixed with cool water from the freshwater source to achieve an appropriate temperature before it flows to the motorhome's hot water faucets.

Both the Aqua-Hot 250 and 125 Series units have an electric heating element that augments the diesel, propane, or gasoline burner. The electric element is useful when the motorhome is connected to shore power and will maintain a constant temperature of the heat-exchange fluid. However, the fueled burner is the main heating source, providing maximum heating of either the ambient air or water. Selection of either the fueled burner, the electric heating element, or both is made on the motorhome's multiplex control screen.

*NOTE: Diesel or Gasoline-fueled systems draw fuel directly from the vehicle's fuel supply tank. The fuel pick-up is designed to only draw fuel when the vehicle's fuel tank is more than 1/4 full. If the fuel supply is at 1/4 tank or lower, the Aqua-Hot system will not operate.*



Aqua-Hot 125 Series main unit

Detailed information regarding hydronic heating systems is not covered in this manual. Refer to the manufacturer's use and care guide included with your TMC Owner's Packet, or available through the on-line TMC Owners Resource, or visit the manufacturer's website.



Typical Aqua-Hot hot air heat exchanger.

### Operating Controls:

The operating controls for the Aqua-Hot system are integrated into the Multiplex System Control Panel (see Multiplex section). On this panel:

1. The Aqua-Hot unit (fueled burner and electric element) can be turned ON and OFF
2. Control the temperature settings for all heat zones

### Bring the Aqua-Hot up to Operating Temperature:

Your Aqua-Hot hydronic heating system heats a water and antifreeze solution that is stored in the Aqua-Hot's boiler tank. This water and antifreeze solution must be up to operating temperature before the Aqua-Hot will provide interior heat or continuous hot water. To bring the Aqua-Hot up to operating temperature, turn the burner switch to the ON position. Depending on the ambient temperature, it may take ten to twenty minutes for the Aqua-Hot's water and antifreeze solution to reach operating temperature.

Once the tank is up to operating temperature, the electric element may be used to maintain the operating temperature and provide light duty hot water and interior heat. For continuous hot water, or heat in colder conditions, the burner must be ON.

### Operating Instructions:

1. **STOP!** Read all safety and warning labels affixed to the unit and printed in the manufacturers owner's manual.
2. This appliance is equipped with an ignition device, which automatically lights the burner. Do not try to light the burner by hand.
3. Ensure that the gas control valve is turned ON (LP-fueled systems). If you don't smell gas or fuel vapors, go to the next step.
4. Turn ON the burner and electric heating element. Controls are located on the Multiplex Control Panel.

5. Set the desired room temperature, either on the Multiplex Control Panel or if available, on the zoned thermostats located in separate rooms of the motorhome.
6. If the appliance will not operate, follow the instructions, 'To Turn Off Gas To Appliance,' listed below, or refer to the manufacturers owner's manual troubleshooting section, or call Aqua-Hot's technical support department at 1-800-685-4298.

### To Turn OFF Gas to the Appliance (LP-fired systems):

1. Ensure the burner control is turned OFF.
2. Turn OFF all electric power to the appliance if service is to be performed.
3. Set all interior thermostats to their lowest setting.
4. Turn the gas control knob located on the heater's propane inlet port clockwise to the OFF position.

### Controlling Heat Levels with Room Thermostat:

When the Aqua-Hot is ON and up to operating temperature, and the interior room thermostat is set to HEAT, adjust the room thermostat to the desired temperature and Aqua-Hot's heating control will automatically maintain the desired interior temperature.

### Using Hot Water:

The Aqua-Hot system is known as a tankless or on-demand hot water heating system because hot water is not stored within a hot water tank or hot water heater. Instead, when the burner and/or electric element switch is ON and the Aqua-Hot is at operating temperature, the water is automatically heated as it is being used. Therefore, simply open a hot water faucet, once the system is up to operating temperature, and a continuous supply of hot water will be present within a few seconds.

### To operate the electric heating element:

- Turn the electric heating element switch ON (located on the Multiplex Control Panel). This action will activate the 120-volt AC electric heating element and the indicator light on the panel.
- Allow 1-2 hours for the Aqua-Hot system to reach operating temperature (if only using the electric heating element).
- For **MAXIMUM** water heating capacity, activate both the fueled burner and electric element.

*NOTE: The fueled burner must be ON for continuous hot water.*

## Maintenance and Important System Information

### **⚠ DANGER**

When the Aqua-Hot is at maximum operating temperature, the coolant will be very HOT! If the Aqua-Hot's heating system is accessed, scalding hot vapor or coolant could result. Before cleaning or servicing, disconnect all power and turn off burners.

### **⚠ WARNING**

- Not winterizing the Aqua-Hot when freezing temperatures are present will result in **SERIOUS** damage to the Aqua-Hot's domestic Water Heating System.
- Only use anti-freeze solution approved by the manufacturer in the Aqua-Hot system. NEVER use automotive antifreeze/coolant or RV Winterizing antifreeze in the Aqua-Hot system.

### **NOTICE**

It is possible to operate the Aqua-Hot as a warm air furnace (without hot water function) after the water system has been properly winterized. Refer to the manufacturer's instructions regarding cold weather operation of the hydronic heating system.

#### General care

The Aqua-Hot system requires minimal maintenance if routine and proper winterizing procedures are followed accurately. It is extremely important to follow the manufacturer's instructions precisely to receive the best results and promote longevity of your Aqua-Hot system.

The Aqua-Hot's fluid levels should be checked regularly to ensure it is maintained at the proper operating level. This can be easily accomplished by visibly checking the coolant level in the Aqua-Hot's expansion tank. It should be checked when the Aqua-Hot is at maximum operating temperature, when the burner completes a cycle, or when the electric element disengages. The level should be at the "HOT" mark on the expansion tank.

If the fluid level needs to be replenished, only use the appropriate antifreeze type, mixed with distilled (de-ionized) water, at the manufacturer's recommended antifreeze-to-water ratio.

At maximum operating temperature, the antifreeze and water heating solution should be at the level marked HOT on the expansion tank. The coolant level should be checked ONLY when the Aqua-Hot is at MAXIMUM OPERATING TEMPERATURE. Therefore, this procedure should be done immediately after the fueled-burner cycles OFF. If the system needs fluid, reference the FLUIDS section of the Aqua-Hot's Use and Care Guide.

#### Annual Maintenance

In order to keep the Aqua-Hot running at its full potential, it is highly recommended to have the fueled-burner tuned-up on an annual schedule. This tune-up consists of replacing these two components:

- Fuel nozzle
- Fuel filter

Always use OEM parts. Reference the Aqua-Hot owner's manual for ordering information or contact your dealer's service department to schedule a service appointment.

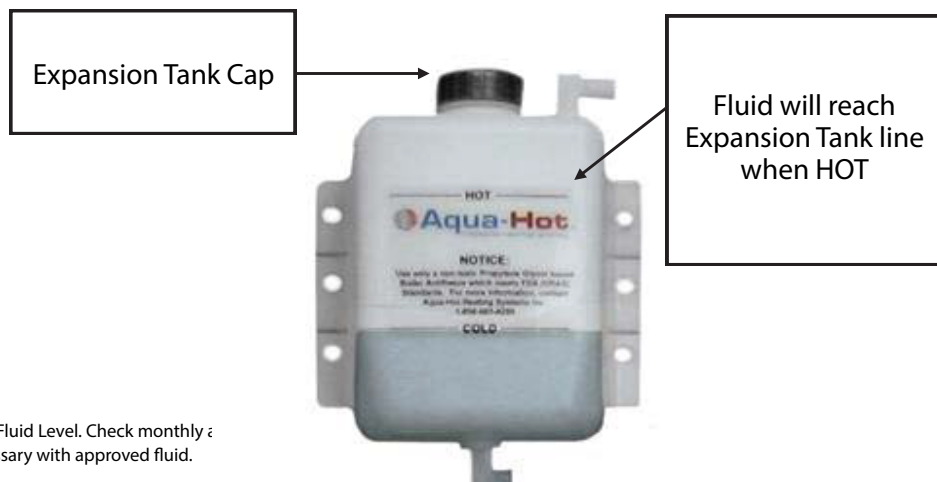

Aqua-Hot System Fluid Level. Check monthly & top off when necessary with approved fluid.

## Sanitizing the Hot Water System

### **NOTICE**

**The Aqua-Hot system contains copper tubing which is not compatible to prolonged exposure to sodium hypochlorite (bleach or liquid bleach). Using products containing bleach for sanitizing of the water heater may cause corrosion of the water coil, resulting in catastrophic failure of the Aqua-Hot system, by creating leaks that cannot be repaired.**

Usually, sanitizing the water system only pertains to the cold water fresh storage tank and the cold water lines, the source for potable, freshwater for the motorhome. However, if it is deemed that the hot water system has become contaminated and is in need of sanitizing, please be sure to limit the exposure of the hydronic system, and other hot water heater types to concentrations of sodium hypochlorite (household bleach).



**NEVER USE BLEACH WITHOUT FIRST DILUTING IT WITH THE RECOMMENDED RATIO OF FRESHWATER.**

Aqua-Hot systems (and many other RV water heaters) contain copper tubing and are not compatible with prolonged exposure to sodium hypochlorite (bleach, or bleach products.) Exposing the internal water coil to products which contain sodium hypochlorite for extended periods of time can lead to corrosion of the water coil and eventually catastrophic failure of the Aqua-Hot unit.

These products can, however, be used as a short term disinfectant. If bleach products are used to disinfect the water system, it is crucial that the system be purged of these products until there is no evidence of chlorine left in the water system. Damage resulting from a failure to purge the internal water coil of sodium hypochlorite solutions is NOT covered by the Aqua-Hot warranty. In addition, Aqua-Hot Heating Systems **DOES NOT** advise the use of water fresheners containing sodium hypochlorite in its units. If a water freshener is required, take special care to ensure that the product **DOES NOT** contain sodium hypochlorite.

Only use the recommended concentrations of liquid bleach and freshwater and only for the recommended time. See Sanitizing the Freshwater System instructions included in this manual. Also refer to the recommendations provided by the water heater's and the hydronic system's manufacturer, and the Standard of Recreational Vehicles 'Instructions for Disinfection of Potable Water Systems,' National Fire Protection Association (NFPA) 1192.

## Aqua-Hot Winterizing

When it is time to store your motorhome for the winter months or when freezing temperatures are expected, it is crucial to properly winterize the Aqua-Hot system **AND** the water system of your motorhome. Damage due to improper cold weather storage or preparation is not covered under the manufacturer's warranty. The process of winterizing consists of completely draining all water from the water system and pumping RV winterizing antifreeze throughout to flush and purge the system of water.

- Refer to the Winterizing Section of this guide to winterize the water system of your motorhome. Only use RV winterizing antifreeze solution for the plumbing and fixtures of the water system.
- Ensure that both the COLD and HOT water lines are filled with RV winterizing antifreeze, along with protecting drains and p-traps.
- To ensure your Aqua-Hot closed-loop heating system is properly winterized, only use approved antifreeze solution with the Aqua-Hot system and add antifreeze solution to the expansion tank as needed. Refer to the manufacturer's recommendations for Aqua-Hot antifreeze solution.

### Aqua-Hot De-winterizing

To de-winterize the Aqua-Hot system, completely fill the freshwater storage tank. Open and close the interior and exterior faucets, one at a time, until only clear water is present.

Information courtesy of Aqua-Hot Heating Systems.

*This page is intentionally blank*

## Requirements to Retain Warranty Coverage

To retain warranty coverage under the TMC Structural and/or Lamination Limited Warranty, **ANNUAL INSPECTIONS by an authorized RV dealer or RV repair service, approved by TMC, are required.** Proof of annual inspections must be retained by the owner of the motorhome and presented to TMC as a condition for warranty coverage. Inspections must be completed on or before the first anniversary of the original purchase of the motorhome and continue annually thereafter on or before successive anniversaries of the original purchase.

A chart showing the annual inspection details is included in your TMC Class A and Class C Warranty Guide. Consult with your dealer and refer to your TMC Warranty Guide for complete warranty information.

## General Information

Periodic maintenance and cleaning of your motorhome is necessary to retain the dependability, safety, and appearance that will provide you with many years of satisfied ownership, as well as protecting your investment.

Make sure you read and follow all the maintenance tips, instructions, and schedules that are included in this manual and also in the manuals provided by the chassis manufacturer and component manufacturers. Keep good records of performed maintenance, inspections, and service. Make sure to perform all owner obligations as may be required to retain your coverages under warranty.

It is also important to note that operating conditions will affect service timetables. Driving in extreme conditions such as heavy dust, continuous short trips, or start and stop heavy traffic means that service durations will be shortened. Discuss service timetables with both your dealer and chassis service representative. Preventative maintenance will pay for itself many times over by catching or preventing problems before they occur. Often, repair costs are greatly increased due to a small problem left unattended, can begin to affect other parts and systems of the motorhome.

If there are cleaning or maintenance or procedures for which you are unsure of performing, please contact your dealer or chassis service representative for recommended instructions.

### NOTES:

- TMC's Limited Warranties require certain owner obligations. Please review the TMC Warranty Guide included in your Owner's Packet or available through the TMC website:  
[thormotorcoach.com/owners/owners-manual/](http://thormotorcoach.com/owners/owners-manual/)
- Obligations and expenses incurred due to performing periodic maintenance service are not covered under Thor Motor Coach's Limited Warranties.
- For more detailed Care and Maintenance information, refer the Chassis Manufacturer's Owner's Manual and TMC's Care and Maintenance Guide, available

## Chassis Maintenance

For information regarding proper maintenance and other important chassis details, refer to the vehicle manufacturer's owner's manual. You, as the owner, are responsible for taking proper precautions when attempting any repair or maintenance for your motorhome. If you are not sure what action to take or are uncomfortable with performing a maintenance or repair function, contact your selling dealer, or a designated chassis manufacturer's service center for assistance. Contact your chassis manufacturer for information on locating a service center near you.

*NOTE: Direct all issues regarding the chassis warranty, parts and service to the chassis manufacturer. Follow the recommendations outlined in the chassis manufacturer's information packet to ensure proper engine performance and fuel economy.*

## Class A Motorhome Engine Access

### **WARNING**

**IF THE ENGINE COVER IS NOT SEATED CORRECTLY, EXHAUST GASES MAY LEAK INTO THE MOTORHOME, CREATING A DANGEROUS AND POTENTIALLY LETHAL CONDITION.**

A Class A motorhome's engine can be accessed for service from inside the motorhome. If you cannot locate the engine cover, please contact your selling dealer or TMC Customer Care for assistance. When reinstalling the engine cover, make sure that it is seated and sealed correctly without obstruction from carpet, floor mats, etc.

## Molds and Mildew

Molds are microscopic organisms that naturally occur in virtually every environment, both indoors and out. Outdoors, mold growth is important in the decomposition of plants. Indoors, mold growth is unfavorable. Left unchecked, molds break down natural materials, such as wood products and fabrics. According to the Center for Disease Control, exposure to damp and moldy environments may cause a variety of health issues. Some people are sensitive to molds. For these people, molds can cause nasal stuffiness, throat irritation, coughing or wheezing, eye irritation, or skin irritation. People with mold allergies may have more severe reactions. Immune-compromised people and those with chronic lung illnesses may develop serious infections in their lungs when they are exposed to molds.

For mold growth to occur, temperatures must be between 40° to 100° Fahrenheit (4° to 38° Celsius) and there must also be a source of moisture, such as humidity in the air, standing water, damp materials, etc. Indoors, the most rapid mold growth occurs when warm and humid conditions exist.

### Inhibiting mold growth:

By controlling relative humidity, the growth of mold and mildew can be inhibited. In warm climates, use of the air conditioner will reduce the relative humidity of the interior air. Opening vents that are located in bathing and cooking areas is advised during food preparation and bathing, even during cool or cold weather. Additionally, opening a window during these activities will assist in ventilation. In extremely humid conditions, the use of a dehumidifier (customer supplied) can be helpful.

Frequent cleaning of the motorhome is an important preventive measure. Spills should be wiped up quickly and dried as soon as possible. Avoid leaving damp items lying about. On surfaces, use mold or mildew killing cleaning products (test cleaning product to ensure it will not damage surfaces). Check window, door, and joint seals regularly and repair or reseal when necessary to avoid water intrusion. Proper regular and preventive maintenance to the motorhome and its accessories will help prevent the formation of molds.

## Condensation

Excess moisture trapped within a motorhome can cause severe long-term damage to laminates, surfaces, fixtures, and other components. Therefore, it is important to follow moisture-reducing procedures as a normal routine of motorhome ownership and maintenance.

### Tips for controlling condensation:

- Allow excess moisture to escape to the outside when bathing, washing dishes, hair drying, laundering, and using appliances and non-vented gas burners by opening ceiling vents.
- Always use the vent hood when cooking.
- Keep the bathroom door closed and the vent or window open when bathing and for a period of time after bathing.
- Do not hang wet clothes in the motorhome to dry.
- In hot weather, start the air conditioner early in the day as it removes excess humidity from the air while lowering the interior temperature.
- Keep the interior temperature set as reasonably cool during cold weather as possible. The warmer the motorhome, the higher the temperature differential between the cold wall surface and the interior air, which can contribute to the formation of condensation on wall surfaces.
- Use a fan to keep air circulating inside the motorhome so condensation and mildew cannot form in dead air spaces. Allow air to circulate inside closets and cabinets (leave doors partially open). Please keep in mind that a closed cabinet full of stored goods prevents circulation and may contribute to the formation of condensation.
- A natural tendency would be to close the motorhome tightly during cold weather. This may actually increase inside humidity. The warm inside air may be more humid than the cool outside air. Allowing some cool outside air into the motorhome may help reduce relative humidity inside the motorhome.

*NOTE: For more information about controlling moisture in your motorhome, refer to TMC's Care and Maintenance System Guide, available through your on-line Owners Resource account.*

## Cold Weather Usage

When using the motorhome in freezing or below freezing temperatures, these precautions should be taken:

- Make proper preparations to avoid freeze damage of the freshwater and drainage systems.
- Propane regulator freeze-ups can occur in any weather if there is moisture in the tank or if the tank has been over-filled. Always use moisture-free propane fuel and make sure the tank is not filled beyond 80% of capacity.
- Ventilation or the use of a dehumidifier (customer supplied) may be required to reduce condensation.
- To avoid damage due to cold weather, check the exterior extrusions for frozen moisture before operating or using the motorhome compartment doors, locks, slideouts, windows, vents, etc.
- To protect from freeze-damage, it may be necessary to winterize the water system. Refer to Section 12, Winterizing the Water System.

*NOTE: Damage caused by the use of your motorhome in freezing temperatures and/or performing deficient cold weather precautionary measures is not covered by the Thor Motor Coach Limited Warranty or the Thor Motor Coach Structural and Lamination Limited Warranty.*

## Extended Stay Usage

### **NOTICE**

**Your motorhome is not designed, nor intended, for permanent housing. Use of your motorhome for long term or permanent occupancy may lead to premature deterioration of its structure, interior finishes, fabrics, carpeting, and/or window treatments, etc.**

**Damage and/or deterioration due to long term occupancy is not considered normal and may under the terms of the warranty constitute misuse, abuse, or neglect, and therefore void certain warranty protections.**

Your motorhome was designed primarily for recreational use and short-term occupancy. If you expect to occupy the motorhome for an extended period of time, be prepared to actively address condensation and the humid conditions that may be encountered.

The relatively compact space of a motorhome means that the normal living activities of even a few occupants could lead to rapid moisture saturation of the air contained in the motorhome. During cold weather, when relative humidity of the interior air is

high, moisture condensation on surfaces can be higher compared to other dwellings because the insulated walls of a recreation vehicle are much thinner, therefore, generally colder. Estimates indicate that a family of four can vaporize up to three gallons of water daily through breathing, cooking, bathing, and washing.

Unless water vapor is carried outside by ventilation or reduced by a dehumidifier (customer supplied), moisture will condense on the inside of the windows and walls of the motorhome. Moisture may also condense out of sight within the walls or the ceiling where it will manifest itself as warped or stained panels. Appearance of these conditions may indicate a serious condensation problem. When using your motorhome, always take necessary precautions to minimize the effects of excessive air-borne moisture and surface condensation.

## Exterior Care

All exterior surfaces require proper care to keep the motorhome in like-new condition. Wash it frequently with warm water, mild detergent, and a soft rag and rinse it thoroughly with clean water to avoid surface spotting. When washing your motorhome, take care to avoid spraying water directly into refrigerator, water heater, and furnace vents. Inspect inside surfaces, particular around doors, windows, corners, and wall-to-ceiling transition areas for signs of water intrusion. Make repairs as soon as water intrusion is detected, thus avoiding certain damage.

After traveling on roads that have been salted for ice and snow, wash the motorhome as soon as possible. The most common causes of corrosion are accumulation of road salt, dirt, and moisture in hard-to-reach areas underneath the motorhome. Make sure to spray-wash the undercarriage and wheel wells. A good automotive surface cleaner may be used occasionally to remove tree sap, road tar, and insects. Do not use naphtha, turpentine, mineral spirits or other solvents on fiberglass surfaces or graphics. Surface damage could occur.

At least once a year, treat fiberglass surfaces with a standard automotive liquid or nonabrasive paste wax. Make sure to follow the directions for use as outlined by the product manufacturer. Wash and wax the motorhome out of the hot sun and when exterior surfaces are cool. Storage of the motorhome out of direct sun helps preserve exterior finishes. Physical damage to exterior fiberglass surfaces should be repaired immediately to avoid moisture from entering through cracks and faults; causing problems with interior walls and components. Cover fiberglass damage with plastic, sealing the edges with tape until proper repairs can be made.

Remember, your motorhome must be annually inspected by a TMC approved and authorized dealer or RV repair service to retain certain warranty-related provisions. Refer to your TMC Warranty Guide for important warranty details.

Tips to keep the exterior of the motorhome looking new:

- Avoid parking under trees or near ocean salt spray.
- Ice or snow should not be scraped from the painted surface. Brush off with a soft bristled brush.
- If the vehicle sits more than 24 hours, remove any front protective covering (bra) while not being driven.
- Commercial vehicle washes should be avoided. Dry wiping with a dry cloth is not recommended.
- Avoid driving the motorhome on gravel roads, but if gravel roads or gravel construction zones are unavoidable, travel at reduced speeds.
- Anti-freeze, gasoline, or window solvent spilled on painted surfaces should be rinsed off with water immediately.
- Rinse off bugs and bird droppings daily with mild soap and rinse with clean water.

If surface deterioration is apparent, contact a Thor Motor Coach dealer for assistance with finish restoration.

## Care of Fiberglass Surfaces

### **NOTICE**

**AVOID ABRASIVE CLEANSERS (even the liquid and cream types), alcohol-based products, and solvents such as acetone and MEK.**

**Gasoline and kerosene should not be used because of the damaging effect they have on the plastic surface, as well as the fire hazard they present. Often the damage caused by solvents, alcohol, citrus-based and oil-based products may not be immediately noticeable, but the plastic is made weaker, and prone to stress cracking.**

DO NOT use rubbing compound or an abrasive cleaner or cloth on the motorhome. If using a tar and insect remover, make sure it is safe for use on painted surfaces and graphic decals.

- The exterior painted finish on the motorhome is of the finest quality. Proper maintenance will assure a long-lasting durable finish. DO NOT wax or polish the exterior for the first 60 days of ownership. This gives the paint proper time to cure.
- DO NOT dry wipe the surface; always wet the surface first with clean water spray, then clean only with water and mild liquid detergents.
- DO wax the sidewalls using nonabrasive automotive waxes or cleaner/polishes developed for use on fiberglass boats, showers, and tubs. Follow the directions on the package.

- Always be extremely cautious when using powered buffing or polishing tools. Improper use can severely damage surface finishes.

## Painted Surfaces

Wash painted surfaces with mild soap and water and soft cloths or sponges; being careful not to use materials that will scratch or mar the surface. Apply an automotive-type protective wax to painted surfaces on an annual schedule.

## Aluminum Surfaces and Extrusions

Clean and wax all trim extrusions when waxing the recreational vehicle sidewalls to help avoid surface pitting. Special aluminum cleaners are available to restore the original luster to aluminum surfaces. Make sure to follow the instructions for use as outlined on the product packaging.

## Cleaning and Maintaining Vinyl Graphics

### **CAUTION**

**Loose graphics could tear away from a moving vehicle and cause an obstruction to motorists and pedestrians. After washing, check all the graphics carefully for edge lifting and repair, remove or replace damaged graphics.**

*Graphics with a screen print clear or over-laminate:*

Use a cleaner designed for high-quality painted surfaces. The cleaner must be wet, non-abrasive, without strong solvents, and have a pH value between 3 and 11 (neither strongly acidic nor strongly alkaline).

*Digitally printed graphics with a clear coat:*

Use a wet, non-abrasive solution that contains NO solvents and NO alcohol and has a pH value between 3 and 11 (neither strongly acidic nor strongly alkaline.)

*Power washing graphics:*

Power washing, or pressure washing, may be used with caution. However, aggressive washing can damage the graphic.

Excessive pressure during power washing can damage the graphic by forcing water underneath the graphic. Water lessens the adhesion of the graphic to the substrate allowing the graphic to lift or curl. These problems are magnified by wind. Avoid pressure washing perforated window graphic films without edge sealing tape.

To avoid edge lifting or other damage to the graphics, follow these important steps:

- Use a spray nozzle with a minimum 40 degree-wide spray pattern.
- Be sure the spray nozzle includes a nozzle protector (tip guard).
- Use a maximum pressure of 1200 psi (80 bar).
- If the system is heated, limit the water temperature to 140°F (60°C) or less.
- Hold nozzle at least 12 inches (300 mm) away from and perpendicular (90 degrees +/- 10) to the graphic or a minimum of 39 inches (1000 mm) away from the graphic at a 30° angle, or higher.
- DO NOT direct the water stream between 0°-60° to the edge of the graphic.

Automatic brush washing may be used, but keep these two points in mind:

- Brushes can catch a loose edge of the graphic and cause further damage to the graphic.
- Brushes can dull the finish of the graphic.

Hand washing exterior graphics:

1. Flush the graphic with clean water to remove loose dirt particles. A trigger-type hose nozzle is convenient for this purpose.
2. Use a mild liquid detergent and water solution and wash the graphic with a soft brush, rag or sponge.
  - a. Wash thoroughly from the top down.
  - b. Avoid abrading the graphic by unnecessary scrubbing.
  - c. After applying the cleaning solution, keep a steady stream of water flowing on the graphic to wash away dirt particles.
3. Rinse the entire graphic thoroughly with clean water. Allow to dry naturally.

Removing difficult contaminants:

Some contaminants may remain after following the normal cleaning procedures. Most contaminants can be removed using one of these methods. Other cleaning products and methods should be used only on a customer test-and-approve basis.

1. To remove tar, oil, diesel smut or bituminous material:
  - a. Wipe with 3M™ Citrus Base Cleaner or a rag dampened with kerosene, mineral spirits, heptane, or VM&P naphtha. Do not use other solvents.
2. To remove pollen and fungus:
  - a. Wash the graphic with 3M™ Marine Mildew Stain Remover (PN 09067), a 3 to 5% sodium hypochlorite (full-strength household bleach) solution, or mild liquid detergent and water.
  - b. Rinse with clean water immediately.
3. To protect the graphic from pollen and fungus, apply 3M™ Marine Mildew Stain Remover as a part of regular maintenance:
  - a. Remove any existing mildew stains. Clean and dry the surface. Using 3M™ Marine Mildew Block (PN 09065), spray surface and gently wipe to ensure a uniform coating over the graphic, including the edges. Ensure a uniform coating without leaving droplets, streaks, or puddles. Remove any over-spray with a damp cloth and allow to dry (typically for one hour). Repeat after cleaning.
  - b. Use of some cleaners can remove the protective coating and reduce the length of graphic protection. To maintain protection, simply re-apply this product after cleaning.
4. To remove crayon, lipstick, or similar materials:
  - a. Select an appropriate solvent and test it in an inconspicuous area to ensure it removes the contaminant without damaging the graphic. This must be done on a customer test and approve basis.
  - b. Wash immediately with mild liquid detergent and water, then rinse with clean water.

Graphic repair:

Once the graphic has been exposed to outdoor weathering, it is not possible to repair to the original state.

Repair is possible if color and/or gloss is not relevant. For vehicle wraps it is recommended to replace total components or replace the full wrap.

Sometimes graphic damage can be repaired, but visible differences will most likely occur. However, repaired graphics are not warranted. Consult with professional automotive paint and graphic detailers for repair options.

Source: 3M Instruction Bulletin 6.5, Revision F, November 2019

## Roof

**⚠ WARNING**

**DO NOT CLIMB ON OR WALK ON THE ROOF WHILE WET, ICY, OR SNOW COVERED. THE ROOF COULD BE VERY SLIPPERY CAUSING YOU TO FALL, WHICH CAN RESULT IN DEATH OR SEVERE INJURY. DO NOT USE THE ROOF AS AN OBSERVATION PLATFORM OR STORAGE AREA, AS IT IS NOT DESIGNED FOR THESE PURPOSES.**

**⚠ CAUTION**

**Although durable, the waterproof roof membrane can be easily damaged by falling branches, scraping by low-hanging objects, or user carelessness. Damage to the roof membrane must be promptly repaired to prevent structural and other damage due to water intrusion.**

Inspect the roof components at least twice a year to make sure that all seals and sealants are not cracked or worn. Proper maintenance of seals is necessary to keep moisture from entering and causing severe damage such as rot, mold, or mildew. If drying, cracked, or weathered seals are detected, make sure to reseal as necessary. Remove the old worn seals first before reapplying the new seals. Check with your dealer for the type of caulking required for thermoplastic polyolefins (TPO) roofs and the correct methods of resealing. Silicones and synthetic sealers cannot be used on the rubber roofs. Special sealers are also required for the skylights. If desired, your Thor Motor Coach dealer may perform the periodic roof seals and sealant maintenance.

It is especially important to check the seals before and after periods of extended storage or non-use. Fall and spring inspections



Features installed on an RV's roof require maintenance attention.

are recommended. Check the roof membrane for possible damage and check all accessories and fasteners. The roof may be cut or punctured by sharp objects so care must be taken when parking and driving. If damage does occur, the roof may be patched. Check with your dealer for additional information. Parking in areas where leaves, fruits, nuts, or tree sap may stay on the roof for extended periods of time may result in irremovable stains.

## Normal Cleaning

- Use a mild detergent and warm water (if available).
- Rinse the entire roof surface with clean water to remove any loose dirt or debris.
- Use a soft to medium nylon bristle brush along with your selected detergent, mixed with water, and scrub the entire roof. Rinse thoroughly with clean water to avoid residue buildup on the roof or sidewall of the unit.
- For more difficult stains contact your Thor Motor Coach dealer for the correct heavy-duty cleansers. Do not use general-purpose cleaners containing petroleum solvents, harsh abrasives, or citric based cleaners.
- If the roof membrane is torn or punctured, cover the damage to seal out moisture, and have it repaired as soon as possible (check with your dealer for proper repair methods).

The membranes used on the roof may have an extended warranty that is covered by the membrane manufacturer. This is for manufacturing defects only and does not include leaks or punctures due to improper sealing, normal wear and tear, or owner damage. See membrane manufacturer's warranty for details.

## Roof Vents and Vent Hoods

Check roof vents regularly for debris that may block air flow or jam the cranking mechanism. Lubricate the cranking mechanism with light oil.

## Antennas, Satellite, and Wi-Fi Extenders

To lubricate the elevating gear, apply a liberal amount of silicone spray lubricant to the elevating gear with the lift in the down position. Operate the mechanism up and down a few times to distribute the lubricant over the gears.

If rotating the antenna becomes difficult, lubricating the bearing surface between the rotating gear housing and the base plate can restore operation. Any spray type silicone lubricant may be used.

Elevate the antenna and remove the set screw from the rotating gear housing. Spray lubricant into the hole and around the edges of the gear housing. Rotate the gear housing until the lubricant coats the bearing surfaces and the antenna rotates freely. Replace set screw.

## Windows and Doors

Any glass surface will develop water spots if it is not properly cleaned. This spotting effect is magnified when glass has a reflective finish. Use a squeegee immediately after washing to reduce water spotting. There are several aftermarket specialty glass cleaners available that can be used to clean and remove stubborn water spots. The tracks of sliding windows must be kept free of debris to keep drain holes from becoming clogged.

Vinyl seals around windows should be checked every six months, cleaned regularly, and kept pliable by use of a silicone spray. Make sure to follow the directions outlined on the product container.

Make sure that windows remain operative by adjusting and lubricating latches and moving parts annually. Also check the condition and operation of the door locks, adjusting and lubricating as necessary. Use powdered graphite or light oil to lubricate moving parts of doors and windows.

Keep screens and window slides clean and free of debris to maintain proper operation and to avoid component damage. Occasionally test the operation of all windows to ensure they are opening and/or sliding freely. Make sure windows close flush and that the locks hold tight.

Moving parts of the entrance door and lock should be adjusted and lubricated at least once a year or as needed. Screws and fasteners should be checked and tightened periodically. Check weather-stripping seals to assure proper fit and seal. Refer to the Owner's Manual from the door manufacturer for more in-depth instructions for care and maintenance of the entrance door.

*NOTE: Be aware that moisture can accumulate in locks and hinges of windows and doors, causing damage or faulty operation. Do not force the operation of these components in subfreezing weather.*

## Storage Compartments

ABS plastic storage compartments:

Storage compartments are usually constructed of strong, lightweight ABS plastic. During normal use, it may be necessary to remove grime, stains, or other debris from storage compartments. Vacuum dirt and debris and the use of a mild solution of soap and water will remove most stains and grime. Tougher stains may require stronger cleaners but be sure to read the label to determine if the product is recommended for use on plastics. Rinse thoroughly with water and dry.

Avoid abrasive cleansers (even the liquid and cream types), alcohol-based products, and solvents such as acetone and MEK. Gasoline and kerosene should not be used because of the damaging effect they have on the plastic surface, as well



TMC Motorhomes are designed with large exterior storage bays

as the fire hazard they present. Often the damage caused by solvents, alcohol, and oil-based products may not be immediately noticeable, but the plastic is made weaker, and thus more prone to stress cracking.

Cargo trays and storage slides:

Lubricate rollers and glides on an annual schedule. Replace worn components, latches, etc. whenever necessary.



## Maintenance Access Panels

There may be maintenance access panels located in key areas of your motorhome. Access panels allow service and maintenance to electrical, plumbing, gas, and other systems and are identified by a label such as the one depicted here. Access panels may be fastened by screws, bolts, or other fastening devices.

**REMOVE THIS PANEL  
FOR ACCESS TO**

DD-93

Typical Access  
Panel Label

## Seals, Sealants, and Adhesives

### **⚠ CAUTION**

**Use extreme caution when washing and cleaning the exterior of your motorhome, especially around seals, gaskets, and weather-stripping.**

**Pressure-washers and vehicle wash stations can potentially force water past seals and sealing devices, creating water intrusion, which could lead to damage of interior surfaces, structures, and devices.**

It is important to maintain the seals, sealants, and adhesives of your motorhome to prevent moisture from entering and destroying the components. Failure to maintain seals through regular maintenance can lead to damage of motorhome components and may be considered abusive treatment under terms of your motorhome warranty. When washing the motorhome, inspect the seals for signs of drying out, cracking and wear. At minimum, inspect and reseal, if necessary, every six months. Be aware that weather, sun, and road vibration will affect seals, causing them to dry, crack, or separate. If you are unsure what to look for, have your dealer show you the correct method for renewing the seals. If you prefer, your dealer will be able to perform routine seal inspection and maintenance for you.

- Inspect seals around doors, windows, vents, and external seams. If a seal is cracked or dried out, it must be replaced to prevent leakage.
- Inspect roof seals every six months to determine if they are cracked, peeling, or damaged. Repair or replace as needed.
- Inspect engine covers and firewall every six months to determine if they are cracked, peeled, or damaged. Repair or replace as needed.
- Particular attention should be devoted to ensuring slideouts are sealing properly. Regularly inspect slideout seals for chips, cracks, or other damage. Repair or replace damaged slideout seals as soon as possible. Check door, window, and vent seals for cracks, chips or other damage and replace damaged seals as soon as possible.

*NOTE: It is especially important to check the seals before and after periods of extended storage or non-use. Fall and spring inspections are recommended.*

*NOTE: Damage caused by deficient seals and sealant maintenance is not covered under the Thor Motor Coach Limited Warranty.*

### Cleaning Dirt and Grime from Sealants

Dirt and road grime often collects onto the surface of exposed sealants, particularly around exterior corner and joint moldings. If normal methods of exterior surface cleaning does not remove dirt from exposed sealant surfaces, TMC recommends the following cleaning procedure:

1. Clean the exterior surfaces of the motorhome as described previously in this section.
2. When the exterior surfaces are dry, dampen a soft cloth with Denatured Alcohol.
3. Gently rub the exposed sealant with this dampened cloth, while frequently turning the cloth to avoid re-depositing grime from the cloth back onto the sealant surface.
4. Be cautious when cleaning around vinyl graphics with any type of solvent. Refer to the previous pages about solvents and vinyl graphics.

## Slideout Maintenance

Slideout gear tracks and seals should be kept clean and free of dirt and debris. Wash with mild soap and water. A light coating of vinyl and rubber conditioner can be used on the seal to keep it supple.

No grease or lubrication is necessary for the gear track, and in some situations, lube and oil may even be detrimental to the long-term dependability of the system.



Keep slideout gear tracks and seals clean for proper maintenance and trouble-free operation

## Storing the Motorhome

During periods when your motorhome is not in use, care must be taken to ensure damage to your motorhome caused by excessive moisture and other conditions does not occur. The ideal storage location of your motorhome would be in an enclosed, climate-controlled facility; however, this is not always possible. Follow these important storage steps to protect your motorhome:

- Turn OFF and disconnect from all water sources.
- Turn OFF all combustion appliances.
- Winterize your motorhome's water system.
  - a. Drain and flush all holding tanks.
  - b. Drain the water heater tank and freshwater lines.
  - c. If freezing temperatures are expected, treat plumbing pipes and fixtures with RV antifreeze.
- Slightly open all closets, cabinet doors, and drawers; this allows for air circulation.
- Close all windows and entrance doors.
- Open a roof vent enough to allow for some limited ventilation, but not so far as to allow snow or rain to enter the motorhome.

*NOTE: When storing your motorhome in humid conditions the use of a dehumidifier or chemical desiccant may be required. Run drain hoses to the outside of the motorhome to prevent potential overspill of catch basins. Please read and follow all manufacturer instructions and recommendations for the use, cleaning, and maintenance of the dehumidifier and chemical desiccants.*

## Winter Storage

When storing your motorhome for the winter, extended periods, or in other extreme conditions, certain precautions need to be made to protect it from possible damage. Make sure to talk with your local RV dealer concerning any special requirements for long-term storage in your geographic area. The following steps are general, and your dealer can help you choose those that are most appropriate to your needs.

### Chassis:

Perform chassis maintenance and recommend storage procedures outlined by the chassis manufacturer (refer to the chassis manufacturer's owner's manual).

### Tires:

Block up motorhome with wooden blocks or on a hard, level surface to relieve the constant pressure on one area of the tires. Inflate tires to their maximum pressure. Cover to protect against sunlight with burlap, plywood or specially designed tire covers, which are available at RV dealerships.

### Battery(ies):

- Be sure that both the chassis and auxiliary (house) batteries have the proper electrolyte level and that they are fully charged. Add distilled water and recharge if necessary. (NOTE: batteries installed in your motorhome may be sealed or maintenance-free).
- Batteries should be checked for charge at least monthly. Use of a trickle-charger may be appropriate. Inquire with the battery manufacturer regarding trickle-charging methods. A discharged battery could freeze and may crack the case, causing severe damage to the battery and surrounding area. In storage, a battery will lose charge gradually over a 30-to-45 day period, even when disconnected from the positive and negative battery cables.
- You may wish to remove the batteries from the motorhome and store them in a heated area (approximately 50–60° F; 10–15° C). However, even in warm storage, the battery charge level must still be maintained.

### Fuel:

Store the motorhome with a full fuel tank, treated with a fuel additive to prevent condensation buildup and fuel degradation. Use fuel additives recommended by the chassis manufacturer.

### Dash air conditioner:

Operate the unit for a short period of time throughout the storage period to assure the compressor seal is lubricated.

### Exterior:

Clean and wax exterior surfaces. Lubricate locks and hinges. Seal roof joints and mounting points as needed. Follow exterior cleaning guidelines outlined in the TMC Care and Maintenance System Guide, available through your on-line Owners Resource account.

### Windows:

Treat seals with silicone spray. Close and lock. Inspect exterior body seals and reseal if necessary.

### Roof:

Keep the roof clear of significant snow accumulation or damage may occur. Inspect and reseal if necessary.

**Appliance vents:**

Check all furnace, water heater, refrigerator, range hood, and A/C vents for blockages. Remove nests created by pests and other debris. Inspect periodically throughout the storage period and keep vents open.

**Air conditioner(s):**

Remove air filters and clean or replace. Cover the shroud.

**Hydraulic leveling and electric stabilizing systems:**

If installed, store your motorhome with the hydraulic jacks and stabilizers in the UP position.

**Generator:**

Prepare the generator for long-term storage as outlined in the manufacturer's instruction manual.

**Water system:**

Winterize the water system as outlined in the Water System Section of this manual.

**Propane system:**

- Inspect all hoses, pipes, valves, joints, and couplers for leaks. Refer to Propane Leak Test in Propane Section.
- Turn off all propane supply valves and appliances and keep vents open, while preventing vents and intakes from becoming blocked due to insects or rodent nests.
- After storage, inspect entire propane system, including vents, before use.

**Interior:**

- Remove all food items.
- Clean all interior surfaces and fabrics.
- Inspect the interior of the motorhome monthly while in storage to make sure leaks have not developed, or condensation has not formed that can cause damage to interior components. Condensation can most readily be observed as moisture accumulation on windows and exterior surfaces. To reduce condensation, make sure to ventilate the motorhome during storage.
- Use insect and rodent repellents to protect against damage, following repellent manufacturer's guidelines. Test to ensure repellent will not damage surfaces.

**Curtains and blinds:**

Close all the drapes and curtains and protect the curtains from sun fading by placing foil or paper between the windows and the curtains/blinds.

**Microwave, cooktop, and oven:**

Clean interior and exterior surfaces with mild detergent and water. Wipe dry. Ensure all appliances are OFF.

**Refrigerator:**

Clean inside and outside surfaces. Leave doors propped slightly open to allow for air circulation. Leave an opened box of baking soda inside the refrigerator to prevent odors.

**Sinks, toilet, and shower:**

Clean with disinfectant and dry. Pour one cup of nontoxic RV antifreeze into the drains to prevent freezing. Wipe-up any spilled antifreeze from surfaces.

## Additional Care and Maintenance Information

For additional information regarding the care and maintenance of your motorhome, please refer to your Chassis Manufacturer's Owner's Manual and TMC's Care and Maintenance Guide, and other documents and videos available to view and download from the TMC Owners Resource Information Service.

[thormotorcoach.com/owners/](http://thormotorcoach.com/owners/)

- Follow all maintenance instructions provided by the component manufacturers of the devices installed in and on your motorhome.
- Refer to the vehicle manufacturer's owner's and service manuals for care and maintenance of the chassis, drive train, and other components that comprise of the vehicle portion of this motorhome.
- Inquire with your RV Dealer about important care and maintenance information.
- Contact TMC's Customer Care for questions and guidance regarding maintenance and important warranty and service information.

Telephone (toll free): 877-855-2867

Email: [wsupport@tmcrv.com](mailto:wsupport@tmcrv.com)

[thormotorcoach.com/company/contact-us](http://thormotorcoach.com/company/contact-us)

## Maintenance Schedule

The following maintenance schedule contains information pertaining to the living quarters of this motorhome. Follow

the vehicle manufacturer’s recommendations for servicing and maintaining the vehicle (motorized) portion of this motorhome.

ITEM	EVERY TRIP	EVERY MONTH	EVERY 3 MONTHS	EVERY 6 MONTHS	EVERY YEAR	PRIOR TO STORAGE	AS REQUIRED	PROCEDURE TO BE PERFORMED: Maintenance schedules are minimum requirements. Heavy use, unusual temperatures or humidity, or other extreme conditions may require more frequent maintenance.
Engine/Chassis	•			•			•	Check engine oil and top off with type recommended by chassis manufacturer. Change oil and filter at recommended mileage intervals.
	•						•	Check fluid levels including: brake, steering, coolant, transmission, washer, etc. Top off reservoirs as needed with fluids recommended by chassis manufacturer.
	•						•	Inspect underneath engine and transmission for leaks. Repair as necessary.
				•			•	Inspect air and fuel filters and replace at interval recommended by chassis manufacturer.
					•		•	Inspect chassis battery, terminals and cables. Repair and replace as necessary.
					•		•	Inspect suspension, steering components, exhaust systems etc. Repair and replace as necessary.
	•						•	Generator exhaust: inspect for cracks, blockages, damage. Replace immediately if any faults are discovered.
Brakes	•		•			•	•	Check fluid levels. Top off reservoir as needed with fluid specified by chassis manufacturer and only from an unopened container.
				•			•	Inspect pads and rotors. Replace as necessary.
	•				•		•	Inspect parking brake for proper function. Repair and replace as necessary.
	•						•	Inspect brake lights and turn signals for proper function. Repair and replace components as needed.
Weight Distribution	•						•	Check for proper weight distribution of equipment and components. Place heavy items as near and over axles as possible.
							•	Weigh loaded motorhome with vehicle scales to determine loading. Do not overload vehicle per GAWR and GVWR ratings (see manufacturers specifications).
Tires	•						•	Inspect for proper inflation (PSI). Inflate to proper cold pressure (PSI). Inspect for wear. Repair or replace ONLY with tire(s) of proper size and load rating. Unusual wear patterns indicate problems that should be addressed by qualified technicians.
	•						•	Check all wheel lug nuts and tighten using a properly calibrated torque wrench. Torque per chassis manufacturers specifications.
	•						•	Inspect spare tire for proper inflation (PSI). Inspect for cracking, aging. Replace as necessary.
Wheel Alignment							•	Inspect tires for uneven wear, dents in the wheel rims, and if vehicle steering seems unusual. All are indications that front wheels need re-aligned. Align as needed with a fully loaded vehicle and only by qualified technicians.

ITEM	EVERY TRIP	EVERY MONTH	EVERY 3 MONTHS	EVERY 6 MONTHS	EVERY YEAR	PRIOR TO STORAGE	AS REQUIRED	PROCEDURE TO BE PERFORMED: Maintenance schedules are minimum requirements. Heavy use, unusual temperatures or humidity, or other extreme conditions may require more frequent maintenance.
Safety Equipment		•			•			Test smoke alarm. Replace battery annually.
		•			•			Test combination LP/Carbon Monoxide alarm. Replace promptly if found to be inoperable.
				•			•	Inspect fire extinguisher for proper pressure. Replace if low or after any use.
Seatbelts			•				•	Inspect driver and front passenger lap and shoulder belts for wear or defective latches. Replace worn or defective components promptly.
	•		•				•	Inspect all passenger seatbelts and latches and replace worn or defective components promptly.
	•		•				•	Inspect child safety harness brackets and tighten bolts if loose. Replace faulty components promptly.
Exterior: windows, doors, seals	•						•	Inspect windshield for cracks, chips, and damaged seals. Repair and replace as needed.
					•		•	Check vinyl seals around slideouts when washing exterior. Repair and replace as needed.
			•				•	Check door and window seals for damage. Repair as needed.
							•	Lubricate power step components with spray or lithium grease.
					•			Lubricate hinges, locks, & strike pockets of entrance, storage, and maintenance access doors.
		•					•	Operate emergency egress window latches and open window(s) frequently to ensure easy operation. Lubricate seals and latches with light coating of silicone grease.
							•	Inspect external corner and edge molding for damage; repair and reseal as needed.
					•		•	Inspect and replace wiper blades and windshield washer system components as needed.
Exterior: fiberglass			•					Wash surface with warm water and mild detergent. Do not use solvents or abrasive cleaners.
					•			Wax with liquid or paste non-abrasive automotive wax.
Exterior: roof			•			•	•	Inspect and reseal roof and component attachments; vents, antennas, ladders, HVAC, etc.
			•			•	•	Clean roof surface with warm water and mild detergent.
					•		•	Lubricate fan and power vent mechanisms with light oil. Clean surfaces as needed.
					•		•	Inspect air conditioner(s) housing, mounting, condensation drains, etc. Repair and replace as needed.
					•		•	Inspect ladders for broken rungs, loose mounting components and bent rails. Replace as needed.
Exterior: lights	•						•	Inspect running, clearance, side-marker lights and repair or replace as needed.

ITEM	EVERY TRIP	EVERY MONTH	EVERY 3 MONTHS	EVERY 6 MONTHS	EVERY YEAR	PRIOR TO STORAGE	AS REQUIRED	<b>PROCEDURE TO BE PERFORMED:</b> Maintenance schedules are minimum requirements. Heavy use, unusual temperatures or humidity, or other extreme conditions may require more frequent maintenance.	
Exterior: mirrors, vision systems	•						•	Inspect rear-view mirrors and adjust when needed. Replaced broken mirrors and components promptly. Inspect rear and side-view vision systems for proper operation. Repair and replace components promptly.	
Awnings: patio, door, & window	•						•	Operate awnings to ensure proper functioning.	
			•				•	Clean awning fabric with warm water and mild detergent. Allow fabric to dry before retracting. Lubricate hinges and joints with silicone grease.	
Awnings: slideout topper			•				•	Inspect for proper operation, wear, or damage. Repair and replace as needed.	
Slideouts: electric	•						•	Inspect and test for proper operation. Inspect gear tracks for unusual wear. Lubricate per manufacturers recommendations.	
Slideouts: hydraulic	•						•	Inspect and test for proper operation. Inspect rams and hydraulic fittings and hoses for leaking fluids. Top off reservoir with fluid recommended by manufacturer.	
Leveling System: hydraulic	•						•	Inspect leveling system for proper function. Ensure jack rams extend properly and fully retract and stay retracted. Ensure jacks deploy only when vehicle's transmission is in park and the parking brake is engaged. Inspect hydraulic lines for leaks. Inspect hydraulic fluid reservoir, top off as needed with manufacturers recommended fluid.	
Stabilizers: electric	•						•	Ensure stabilizers deploy properly and fully retract. Clean deployment mechanism with mild detergent and rinse with water. Lightly lubricate as needed. Inspect jack pads for damage. Replace worn or damaged components as needed.	
Cab/Cockpit	•						•	Vehicle horn: test for proper function, repair if defective.	
	•						•	Gauges and switches: ensure all vehicle control functions and driver aids are in proper working order before every trip. Repair and replace as needed.	
								•	Cockpit seating: lubricate mechanisms, repair or replace damaged seats or seating components.
								•	Engine cover gasket: Inspect for proper fit and seal. Replace if damaged.
								•	Inspect heater and air conditioner for proper function. Repair as necessary.
Electrical System: 12-volt			•				•	Check and service auxiliary and chassis battery(ies). Add ONLY distilled water as needed or replace batteries that fail to hold a charge. Do not attempt to open maintenance-free batteries. Keep batteries on trickle charge when stored for an extended period of time.	
					•		•	Check battery charging system: chassis alternator, inverter/converter, solar controller. Ensure proper charging voltage via multimeter reading (battery manufacturers charging recommendations).	
	•							•	Multiplex system (if installed): check using 'Hot Skin Test'; with a multimeter set to 12-volts, place one probe on main panel and one probe to a known ground. There should be no voltage. If voltage is present, have multiplex system inspected by a qualified technician.

ITEM	EVERY TRIP	EVERY MONTH	EVERY 3 MONTHS	EVERY 6 MONTHS	EVERY YEAR	PRIOR TO STORAGE	AS REQUIRED	<b>PROCEDURE TO BE PERFORMED:</b> Maintenance schedules are minimum requirements. Heavy use, unusual temperatures or humidity, or other extreme conditions may require more frequent maintenance.
Electrical System: 12-volts, continued			•				•	Check for Multiplex software updates from the multiplex system manufacturer.
	•						•	Interior 12-volt lighting: repair and replace as needed.
							•	Check 12-volt power plugs, USB ports and electronic device charging stations. Repair or replace as needed.
					•		•	Inspect automatic transfer switch (ATC), inverter, and converter for proper function. Replace fuses or faulty circuit breakers.
	•						•	Inspect radio, navigation, and camera monitoring system. Repair as needed.
					•		•	Inspect towing electrical plug (4-way or 7-way). Apply electrical contact spray or electrical contact grease to contact surfaces.
				•				Solar panels (if installed): clean solar panels with water spray and soft cloth (do not use detergents or abrasive cleaners).
Electrical System: 120-volt	•						•	Inspect shore cords, receptacles, extension cords for damage. Repair or replace as necessary.
							•	Inspect fuses and circuit breakers at the fuse box or circuit breaker panel. Replace blown fuses ONLY with type and rating indicated on the panel. Have a qualified electrician inspect circuits associated with blown fuses or circuit breakers to determine if additional repairs are required.
		•					•	Generator: perform maintenance procedures per manufacturers recommendations. Check generator engine oil level regularly and top off as needed with oil type recommended by manufacturer. Check air filter and spark plug, replace as needed.
		•						Test ground fault circuit interruption (GFCI) receptacle(s) to ensure their proper function.
							•	Inspect 120-volt electrical receptacles. Repair and replace as necessary.
Propane System				•				LP tank, pipes, fittings: check for leaks and damage by using a mild soapy solution to detect leaks. Tighten fittings and/or repair as necessary.
					•			LP line pressure: inspect and check tank and gas line pressures by a qualified LP technician.
							•	LP tank purge (new tanks): purge tank of inert gas and fill with propane at certified propane dealer and/or supplier.
Water System			•				•	Water hoses, pipes, and fittings: inspect for leaks or damage. Repair or replace as necessary.
	•						•	Bathroom and kitchen fixtures: inspect toilet(s), sinks, shower, and faucets for leaks and damage. Repair as necessary.
	•						•	Water pump: ensure proper operation. Repair as necessary.
	•						•	Wastewater system: inspect drains and holding tanks. Repair clogs. Inspect termination valves and caps. Repair leaks and replace damaged components as necessary.

ITEM	EVERY TRIP	EVERY MONTH	EVERY 3 MONTHS	EVERY 6 MONTHS	EVERY YEAR	PRIOR TO STORAGE	AS REQUIRED	<b>PROCEDURE TO BE PERFORMED:</b> Maintenance schedules are minimum requirements. Heavy use, unusual temperatures or humidity, or other extreme conditions may require more frequent maintenance.
Water System, continued			•				•	Water heater: inspect for leaks. Inspect gas line for leaks. Inspect inlet and exhaust for insect nests or other restrictions. Repair and replace damaged components. DO NOT SANITIZE.
			•				•	Inspect water supply hose, water filter(s), water pressure regulator, water service hose, and sewer hose for damage. Repair and replace as necessary.
				•		•	•	Sanitize and flush freshwater system.
						•	•	Winterize fresh and wastewater systems.
Heating System	•				•		•	LP (gas) furnace: inspect for function. Inspect exhaust ports for restrictions. Have qualified service technician inspect furnace annually. Repair and/or replace faulty components immediately.
	•				•		•	Hydronic heating system: inspect for proper function. Inspect fuel filter. Inspect hydronic fluid reservoir and top off with fluid recommended by manufacturer. Inspect burners and igniters and replace at recommended intervals. Have system inspected by qualified technician annually.
Air Conditioner(s), Heat Pump(s)	•				•		•	Inspect for proper function. Inspect and clean filters. Repair or replace faulty components as necessary.
Appliances: LP (gas)	•						•	Check ranges, ovens, refrigerators for proper functioning. Repair gas leaks immediately.
Appliances: electric	•						•	Check microwave, refrigerator, fans and vents. Repair or replace as necessary.
Entertainment Systems			•				•	Inspect TV's, radios, DVD player, sound systems, Wi-Fi extender, lifts, and mounting brackets. Repair and replace as necessary.
Beds, Bunks	•						•	Inspect bed/bunk lifts for proper function. Repair damaged lift mechanisms immediately.
					•		•	Bed conversions: inspect for broken or damaged brackets. Lightly oil hinges and joints. Repair and/or replace damaged components.
Furniture							•	Inspect sofas, dinettes, tables, etc. Repair or replace damaged components.
Fabrics and Upholstery							•	Clean with mild household detergents and upholstery cleaners.
Countertops							•	Clean with mild, non-abrasive household cleaners and soft cloths.
Bath Fixtures, Sinks							•	Clean with mild, non-abrasive household cleaners and soft cloths.
Carpets, Flooring							•	Vacuum and mop and shampoo as necessary. Use water sparingly and wipe-up immediately.

*This page is intentionally blank*

# Index

4G System, 100  
4-way connector wiring, 58  
5G networks, 100  
5G System, 100  
7-Way Connector, 58  
10 amp Controller, 157  
12 Volt Cooler/Freezer, 84  
12-volt Power System, 145  
30-amp Controller, 157  
30 Amp Shoreline Power Cord, 167  
50 Amp Shoreline Power Cord, 167  
120 Volt Electrical System, 166

## A

About This Owner's Manual, 9  
Absorption mode, 182  
Absorption Stage, 156  
Access Panels, 100, 243  
AC-DC converter, 145, 146, 154  
AC-DC Converter, 146, 156, 161  
AC Outlet, 185  
AC to DC Converter, 181  
After Business Hours Assistance, 15  
AGS, 93, 123, 127, 161, 171, 174, 175  
AGS10, 149, 175, 176  
AGS10 Automatic Generator Start, 176  
AGS15, 147, 148, 149, 175  
AGS15 Control System, 147  
Air Conditioners, 227  
Air Suspension Control Lever, 62  
Alignment, 47  
Alternator, 155, 163  
Android, 11, 96, 131, 132, 133, 135, 138, 147, 149, 175  
Apple, 175  
Apple Car Play, 96  
Appliances, 91  
Aqua-Hot, 231, 232  
Aqua-Hot 125 Series, 231  
Aqua-Hot 250 Series, 231  
Aqua-Hot System Maintenance, 234  
Aqua-Hot Winterizing, 235  
ASME, 188, 189  
ATC blade-type fuses, 180  
Audio/Video Distribution, 99  
Automatic Generator Start, 174  
Automatic Transfer Switch, 176  
Automatic Transmission Fluid (ATF), 64  
Automotive-type 12-volt fuses, 181  
Auxiliary Battery Charger, 164  
Auxiliary Battery Charging, 162  
Auxiliary Battery (lead-acid), 153  
Auxiliary battery location, 153  
Auxiliary Solar Panel Port, 159

AVM2210H, 147  
AVM2210H Multimedia Receiver, 147  
Awning Pre-wire, 79  
Awnings, 78  
Awnings, Entry Door, 79  
Awnings, Lights, 80  
Awnings, Patio, 78  
Awnings, Slideout, 80

## B

Basecamp Hydraulic Jacks, 66  
Basic Air Conditioner Operation, 227  
Battery Charging, 155  
Battery Charging, Alternator, 155  
Battery Charging, Converter, 156  
Battery Charging, Solar Energy, 156  
Battery Condition Indicator, 149  
Battery Maintenance, Lead Acid Type, 153  
Battery Monitor, 127, 162  
Battery Replacement, 155  
Battery Storage, 155  
Beds, Bunks, and Seating, 103  
Beds, Cargo Conversion, 119, 120  
Beds, Dinette Conversions, 121  
Beds, Electric Lift, 108  
Beds, Murphy, 117  
Beds, Powered Murphy, 118  
Beds, Safety Systems, 110  
Bicycle Rack, 87  
Black Holding Tank Flush, 221  
Black Tank Flush, 221  
Black water tank monitoring, 203  
Blind Spot Detection, 34, 36, 37, 40  
Blind Spot Detection, Class A, 36  
Blind Spot Detection, Class C, 40  
BMPro, 123, 124, 125, 138, 139, 141, 158  
BMPro, Basic System Operation, 138  
BMPro Cloud, 141, 143  
BMPro Multiplex Systems, 135  
BMPro RVDMS0, 123  
BMPro System Diagram, 136  
Bulk mode, 182  
Bulk Stage, 156  
Bunks, Euroloft, 105  
Bunks, Powered Over-cab, 103  
Bunks, Telescoping ladder, 112

## C

Cable TV, 98  
Cable TV Hook-up, 98  
California Consumers Notice, 14  
Camera monitor, 35  
Camp-ground electrical service stand, 167

Campsite Sewer Hook-up, 219  
Canadian Cargo Carrying Capacity, 55  
Canadian Recreational Vehicle Length, 54  
Canadian Weight Label / Statement of Compliance, 55  
Carbon Monoxide, 22, 24, 193, 248  
Carbon Monoxide (CO), 22  
Carbon monoxide poisoning, 23  
Care and Maintenance, 27, 197, 218, 225, 230, 237, 238, 245, 246  
Care of Fiberglass Surfaces, 240  
Cargo, 31, 46, 51, 53, 55, 57, 85, 89, 119, 120, 202, 215, 243  
Cargo Trays, 89  
Cargo Weight, 51  
CAT6, 99  
Ceiling Fans, 225  
Central Vacuum, 95  
Change of Address or Ownership, 14  
Changing a Damaged Tire, 47  
Chassis Information Notice, 17  
Chassis Maintenance, 237  
Chassis Manufacturer's Owner's Manual, 9  
Chemical Sensitivity, 27  
Child Safety, 32  
Child Safety Restraint System, 32  
Chlorine bleach, 212  
Circuit Breaker Panel, 179, 183, 184  
City Water Connection, 201  
Class B-C fire extinguisher, 21  
Class C Cab-over Bunks, 110  
Cleaning, 244  
Cleaning Roof Surface, 242  
Cleaning Sealants, 244  
Clearance and Side Marker Lights, 43  
Clearance Lights, 43  
CLIMATE CONTROL Menu, 127  
Clothes Washers and Dryers, 94  
Cold Weather, 211, 238  
Cold Weather Usage, 239  
Combination CO/LP Alarm, 24  
Condensation, 238, 246  
Consumer Information, 13  
Consumer's Responsibilities, 13  
Consumidores de California, 14  
Contact TMC Customer Care, 9  
Control Panel, 223  
Converter, 161, 163, 165, 170, 172, 178, 179, 181, 182, 183, 184  
Cooktops, 92, 193, 195, 196  
Cooling the Motorhome, 226  
Curb Weight, 51  
Customer Care, 9

## D

Dash Air Conditioner, 223  
 Dash controls, 34, 223  
 Dash Heater, 223  
 Dash radio, 35  
 Dash Radio, 96  
 Dash Radio and Monitoring System, 147  
 DC to AC Inverter, 178  
 'Dead' Battery(ies), 173  
 Dealer's Responsibilities, 13  
 DEF, 26  
 De-Winterizing, 213  
 Dextron III, 65  
 DIAGNOSTICS Menu, 128  
 Diagnostic Tools, 133, 134  
 Diesel Exhaust Fluid, 26  
 Dirt Devil, 95  
 Dirt Devil CV1500, 95  
 Disclaimer, 2, 11, 16, 101, 145, 165  
 DISCLAIMER, 160  
 Dishwasher, 94  
 Drainpipes, 215  
 Dream Dinette, 121  
 Drive coupler, 72  
 Driver and Front Passenger Seats, 33  
 Dual Electronics, 41  
 Dual Electronics Corporation, 41, 149, 176  
 Dual Fuel Generators, 174  
 Dual-Fuel Generators, 171

## E

Eclipse, 131, 132  
 Egress Window, 28, 30  
 Electrical Connections for Towing, 58  
 Electrical Fault Protection, 170  
 ELECTRICAL Menu, 127  
 Electrical System, 145  
 Electrical System Monitoring, 150  
 Electric Fireplace, 94  
 ELECTRIC Menu, 128, 130  
 Electric Stabilizers, 70  
 Electric Stabilizers, Extend, 71  
 Electric Stabilizers: Manual Operation, 72  
 Electric Stabilizers, Retract, 72  
 Electric Stabilizer Switch Panel, 71  
 Electronic Control Panel, 62  
 Electronic Igniters, 193  
 Emergency (Auxiliary) Start, 152  
 Emergency Egress Procedure, 28  
 Emergency Egress Window, 28  
 Emergency Parking, 43  
 Emergency Weekend Assistance, 15  
 Emprise Multiplex System, 130  
 EMS Override, 129  
 Engine Access, 237

Entertainment Systems, 96  
 Entrance Door Grab Handle, 89  
 Entry Steps, 77  
 Entry step switch, 77  
 Equalization Stage, 156  
 ESpec, 159, 175, 176  
 ESpec Essential, 159  
 Euroloft, 105, 106, 107, 120  
 Exhaust Emissions Treatment, 26  
 Exhaust Fumes, 22  
 Exhaust Gases, 22  
 Extended Stay Usage, 239  
 Exterior Care, 239  
 Exterior Features and Components, 77  
 Exterior Kitchen, 81  
 Exterior Ladder, 86  
 Exterior Shower, 206  
 External Power Source, 168  
 External Propane Hook-up Port, 197

## F

FANS Menu, 127, 128, 130  
 Federal Weight Label, 52  
 Fire Extinguisher, 21  
 Firefly Emprise Multiplex System, 130  
 Firefly Integrations, 123, 125, 127, 134  
 Firefly Multiplex Systems, 127  
 Firefly Phone App, 131  
 Fire Safety, 19  
 Float mode, 182  
 Float Stage, 156  
 Floor Plan Selection, 129  
 Ford Transit Idle Speed Control, 165  
 Formaldehyde, 27  
 Freightliner 24/7 Direct App, 11  
 Freshwater Filter, 206  
 Freshwater Holding Tank, 202  
 Freshwater Holding Tank Drain Valve, 202  
 Freshwater System, 201  
 Fresh water tank monitoring, 203  
 Front Airbags, 31  
 Fuel Cap, 26  
 Fuel gauge, 26  
 Fuel Inlet, 26  
 Fuel selection valve, 174  
 Fuel System Safety, 25  
 Full vehicle trailer, 59  
 Furnace, 25, 27, 91, 174, 204, 211, 223, 224, 225, 227, 228, 229, 230, 246, 251  
 Furnace Care and Maintenance, 230  
 Fuse Panel, 163, 179, 180, 184

## G

Garage, 53  
 Garage Area, 108

Gas leak, 23, 187, 199  
 Gas Range, 195  
 GAWR, 52, 55, 56, 57, 58, 247  
 GCWR, 51, 52, 53, 57, 58, 59  
 Generator, 171  
 Generator Power Rating, 172  
 Generator Starting and Stopping Procedures, 173  
 GFCI, 81, 185, 250  
 Grab Handle, 89  
 Gray water tank monitoring, 203  
 Griddle, 82  
 Gross Axle Weight (GAW), 52  
 Gross Axle Weight Rating (GAWR), 52  
 Gross Combined Weight (GCW), 52  
 Gross Combined Weight Rating (GCWR), 52  
 Gross Vehicle Weight (GVW), 51  
 Gross Vehicle Weight Rating (GVWR), 51  
 GVWR, 51, 52, 55, 57, 58, 59, 88, 247

## H

HDMI, 99  
 Heated Mirrors, 34  
 Heated seating, 113  
 Heat exchanger, 232  
 Heating and Cooling Systems, 223  
 Heating the Motorhome, 228  
 Heat Pumps, 228  
 Holding Tank Heaters, 204  
 Holding Tanks Monitoring, 203  
 HOME Menu, 127, 128, 130  
 How to Obtain Assistance, 14  
 HVAC, 123, 223, 224, 225, 228, 248  
 Hydraulic Jacks, 62  
 Hydraulic Leveling, Extend, 62  
 Hydraulic Leveling, Hydraulic Fluid Recommendations, 64  
 Hydraulic Leveling, Manual Leveling, 64  
 Hydraulic Leveling, Preventive Maintenance, 65  
 Hydraulic Leveling, Retract, 63  
 Hydraulic Leveling System, 62  
 Hydraulic Leveling System Safety, 61  
 Hydraulic Leveling, Zero Point Calibration, 64  
 Hydraulic Pump Unit, 62  
 Hydrogen gas, 153  
 Hydronic Heating, 231  
 Hydronic Heating Systems, 209

## I

Inhibiting Mold, 238  
 Inspections, 86  
 Interior Features and Components, 91  
 Interior, Lighting, 91  
 Interior Lights, 91

- Introduction, 9
- Inverter, 92, 93, 97, 123, 126, 127, 152, 155, 161, 166, 170, 175, 177, 178, 179, 181, 226, 249, 250
- iOS, 131, 132, 139
- ## K
- Key Fob, 148, 149, 175, 176
- ## L
- Ladder, 86, 87, 112
- Lagun Table System, 122
- Laws of the Road, 43
- LCI Basecamp Hydraulic Jacks, 66
- LCI In-Wall Slideout Systems, 73
- LCI On-The-Go Ladder Receiver, 87
- Leveling and Slideout Systems, 61
- Lever Latch, 30
- LIGHTING Menu, 128, 130
- LIGHTS Menu, 127
- Link to TMC Owners Resource, 10
- Lithium-Ion Auxiliary Battery, 160
- Lithium-Ion Battery Safety, 160
- Load index, 48, 49
- Loading Your Motorhome, 57
- Load Shedding, 177
- Low Point Drain Valves, 210
- LP hook-up port, 83, 199
- LP Port, 198
- Lug Nut Torque, 47
- Lyra, 127
- ## M
- Macerating Toilet, 217
- Macerator Pump, 216
- Main Electrical Panels, 125
- Main Gas Valve, 192
- Maintenance, 22, 25, 26, 27, 65, 70, 78, 107, 153, 157, 170, 178, 180, 184, 197, 209, 218, 225, 230, 234, 237, 238, 243, 244, 245, 246, 247, 248, 249, 250, 251
- Maintenance Schedule, 247
- Manufacturer Modified Label, 54
- Massage functions, 113
- Master Battery Switch, 146
- Maximum Loaded Trailer Weight, 52
- Mercon 5, 65
- Microwave/convection oven, 93
- Microwave Oven, 93
- Mid-ship, 111
- Mid-ship Bunk Beds, 111
- Mini Gas, 128
- Mira, 131, 132
- Mirrors, 34
- Mirrors and Vision Systems, 34
- Modem, 17
- Molds and Mildew, 238
- Monitor Panel, 62, 75, 149, 173, 191, 203, 205, 207, 215
- Morryde, 49
- MPPT, 156, 164
- Multiplex, Basic Operation, 126
- Multiplex Control Systems, 123
- Multiplex, Firefly Lyra Screen, 128
- Multiplex, Heating/Cooling Integration, 224
- Multiplex, Integrated Solar Charging Systems, 157
- Multiplex, Remote Control, 126
- Multiplex, Remote Switches, 140
- ## N
- NHTSA, 17, 45, 48, 52
- NOx, 26
- ## O
- Obtaining Service Repair at TMC, 15
- OCCC, 51, 53, 57, 202, 215
- Occupant and Cargo Carrying Capacity (OCCC), 51
- Occupant and Cargo Carrying Capacity Weight Label, 53
- Online Customer Support, 10
- On-The-Go Ladder Receiver, 87
- Optional Appliances, 94
- Outside 120 Volt AC Receptacle, 185
- Over-the-Air TV, 98
- Over-the-range (OTR), 93
- Owner's Packet, 9, 13, 25, 38, 62, 87, 91, 92, 94, 96, 97, 100, 101, 137, 139, 149, 157, 158, 174, 176, 178, 192, 194, 196, 207, 216, 223, 225, 228, 229, 232, 237
- Owners Resource, 10
- ## P
- P65Warnings, 1, 27
- Patio Awnings, 78
- Patio Deck, 88
- PCS, 123
- Pet Tether Bracket, 89
- Phillips 66 Super ATF, 65
- Phthalates, 1, 27
- Pilot Lights, 193
- Potable Water Hose, 201
- Power adapter, 170
- Powered Entry Steps, 77
- Powered Over-cab Bunks, 103
- Powered recline, 113
- Power Load Center, 167, 177, 178, 179, 180, 181, 182, 183, 184, 185
- Propane Fuel Level, 191, 203
- Propane Furnaces, 228
- Propane Gas Regulator, 190
- Propane Gas Safety, 22, 187
- Propane Leak Test, 199
- Propane Safety, 23, 83
- Propane System, 187
- Propane Tank, 189
- PSI, 45
- Puddle Lights, 89
- Pull-out 40 Quart, 12 Volt Cooler/Freezer, 84
- Pull-out Exterior Griddle, 82
- Pull-start, 173
- ## Q
- QR Code, 10, 138
- ## R
- Ramp Door, 88
- Ranges, 92
- Rapid Camp+, 123
- Rear Awnings, 79
- Rear Cargo Door, 31, 57, 85
- Rear vision camera, 35
- Reclining seats, 33, 105
- Redarc BCDC1240D, 164
- Refrigerator, 92
- Regulator Freeze-up, 190
- Remote Switch, 140
- Replacement Parts, 16
- Reporting Safety Defects, 17
- Requirements, Warranty Coverage, 237
- Roof, 86, 87, 158, 226, 227, 228, 242, 245
- Roof-mounted Antenna, 101
- Running Boards, 89
- RV-approved smoke alarm, 21
- RV-C, 123, 156, 157
- RVMaster App, 135, 138, 140
- RVMaster Control Screens, 137
- RVMaster Node, 138, 140, 141
- ## S
- Safe Elevated Bed Use, 110
- Safely Driving the Motorhome, 42
- Safe Towing Tips, 59
- Safety Alerts, 19
- Safety Labels, 19
- Safety lock-out, Theater Seating, 114
- Sanitizing Aqua-Hot System, 235
- Sanitizing Procedure, 212
- Sanitizing the Freshwater System, 211
- Satellite, 242
- SCR, 26

Screen Navigation, 127  
 Screen Navigation, Firefly, 127  
 Seals and Sealants, 244  
 Seatbelts, 31, 113, 114, 248  
 Seating Controls, 114  
 Selective Catalytic Reduction, 26  
 SETTINGS Menu, 127, 128  
 SFA Macerator  
   Toilet, 217  
 Shoreline Cord Plug Adapters, 169  
 Shoreline Cord Reel, 168  
 Shoreline Power, 166  
 Shoreline Power Cord, 167  
 Shore Power Wiring Configuration, 169  
 Short cycling, 227  
 Side View Camera, 34  
 Sirius, 17, 96  
 Slide-Lock, 76  
 Slideouts, Extending, 75  
 Slideouts, Remote Operation, 75  
 Slideouts, Resynchronizing Motors, 75  
 Slideouts, Retracting, 75  
 Slideout Systems, 73  
 Smoke Alarm, 21  
 SmoothTECH, 49  
 Sofa Bed Conversions, 115  
 Sofa, Jack-knife, 115  
 Sofa, Tri-Fold, 116  
 Solar Charging Controller, 10 amp, 157  
 Solar Charging Controller, 30 amp, 157  
 Solar Charging, Integrated Systems, 157  
 Solar Panel Port, 159  
 Solar Panels, 158  
 Solar Prep, 158  
 Spray Port, 206  
 Storage Bay Cargo Trays, 89  
 Storage Compartments, 80, 243  
 Storing the Motorhome, 245  
 Suggestions for Obtaining Service, 15  
 surge protection, 167  
 Swing Latch, 30  
 Switch Panels, 124

## T

TANKS Menu, 128  
 Telescoping Bunk Ladder, 112  
 Televisions, 97  
 Temperature Differential, 226  
 Termination Valves, 219  
 Theater Seating, 113  
 Thermostat, 225, 227, 233  
 Thermostats, 225  
 Thor Diesel Club, 11  
 Thor Diesel Club, Address, 11  
 Thor Motor Coach, Address, 14

Thor Motor Coach Recreational Vehicle  
   Privacy Notice, 16  
 Tilt and swivel seating, 33  
 Tire Identification Information, 48  
 Tire Inflation, 45, 46  
 Tire Inspection, 46  
 Tire Pressures, 45  
 Tire Replacement, 49  
 Tire Safety, 45  
 Tires and Wheels, 45  
 Tires, load index, 49  
 Tire Wear Patterns, 46  
 TMC Basic Operation Guides, 10  
 TMC Instructional Videos, 11  
 TMC Owner's Packet, 9  
 TMC Owners Resource, 10, 194  
 TMC Product Warranty Registration, 13  
 TMC's Limited Warranties, 13, 86, 237  
 TMC System Guides, 11  
 TMC Warranty Guide, 9  
 Toilet, 215  
 Toilet, Flushing Procedure, 216  
 Tongue Weight, 52  
 Touch N' Go Control, 147, 176  
 Touchscreen Navigation, BPro, 135  
 Touch-Screen Panels, 124  
 Tow bar, 59  
 Tow dolly, 59  
 Towing a Vehicle, 59  
 Towing Capacity, 52  
 Towing components, 58  
 Towing Hitch, 58  
 Towing With Your Motorhome, 58  
 TPMS, 46  
 TRAILER BALL, 59  
 TRAILER COUPLER, 59  
 Transit Bars, 76  
 Transport Canada, 14, 17, 33  
 Transporting Pets, 33  
 Traveling With Propane, 188  
 Trickle Charging, 170  
 Turnbuckles, 88

## U

UCP, 208  
 Unloaded Vehicle Weight (UWV), 51  
 USB, 97, 250  
 USB-A, 97  
 USB-C, 97  
 USB Charging Ports, 97  
 USB Charging stations, 97  
 User Control Panel, 208  
 Using the Propane System, 192

## V

Valve Panels, 205  
 Vegatouch, 131, 132, 133, 134  
 Vegatouch Eclipse, 131  
 Vegatouch Mira, 131, 132  
 Vehicle Identification Number (VIN), 14  
 Vehicle Safety, 19  
 Vehicle Safety Features, 43  
 Velvac, 39  
 Ventilation, 27, 225, 239  
 Videos, Instructional, 11  
 VIN, 10, 14, 15, 53, 54  
 Vinyl Graphics, 240  
 Vision Systems, 35

## W

Wall-mounted Thermostats, 225  
 Wardrobe, 111  
 Warranty Registration Form, 13  
 Warranty Repair, 15  
 Warranty repair authorization, 15  
 Warranty Service Availability Notice, 16  
 Wastewater Holding Tanks, 215, 220  
 Wastewater System, 215  
 Water Heater Bypass Valves, 210  
 Water Heaters, 207  
 Water Heaters, Tankless, 208  
 Water Heaters, Tank Type, 207  
 Water Panel, 205  
 Water Pump, 204  
 Water Pump Strainer, 205  
 Water System, 201  
 Website Usage Disclaimers, 16  
 Weighing, Loading, and Towing, 51  
 Weighing Your Motorhome, 56  
 Weight Capacity, 53  
 Weight Distribution, 57  
 Weight Terminology, 51  
 Wheel Alignment, 47  
 Wide-View Mirror, 34  
 Wi-Fi Connectivity, 100  
 Wi-Fi Extender, 100, 101  
 Wi-Fi Extenders, 242  
 Window and Door Maintenance, 243  
 Winegard Air 360, 101  
 Winegard Air 360 Antenna, 101  
 Winterization Port, 214  
 Winterizing, 11, 209, 210, 212, 213, 218, 234, 235, 239  
 Winterizing the Water System, 212  
 Winter Storage, 245  
 Wireless Switch, 141





[thormotorcoach.com](http://thormotorcoach.com)

TMC Part Number 0611687, Revision 251201

